

HELLY HANSEN
**BUYERS
GUIDE
FW2020**



 TRUSTED BY
PROFESSIONALS



ALIVE
SINCE / 1877



**WE MAKE PROFESSIONAL
GRADE GEAR TO HELP PEOPLE
STAY AND FEEL ALIVE**



TRUST TAKES YOU



FURTHER



ALIVE
SINCE / 1877

CONTENT





MEN'S
12 Wintersports
Mountain
Base Layer
Midlayer
Urban
Watersport
B2B

WOMEN'S
82 Wintersports
Mountain
Base Layer
Midlayer
Urban
Watersport

**JUNIOR
KIDS**
146 JR Wintersports
Kids Wintersports

ACCESSORIES
168 Hats and Beanies
Gloves
Socks
Other Accessories
Bags & Backpacks

**MEN'S
FOOTWEAR**
192 Winterboots
Casual Boots and Shoes
Rain Boots

**WOMEN'S
FOOTWEAR**
200 Winterboots
Casual Boots and Shoes
Rain Boot

TECH CLINIC
208 HH TECH CLINIC
Lifa®
Lifaloft™
H2flow™
Helly Tech®
Helox
CIS
Lifepocket™
Tech Partners

**SIZE CHART
AND INDEX**
224

INNOVATION SINCE 1877

From our home in Norway, Helly Hansen has been making professional grade gear that helps people stay and feel alive for the last 140 years.

In 1877, after many years at sea, Norwegian captain Helly Juell Hansen and his wife, Maren Margarethe, began producing oilskin jackets, trousers, sou'westers and tarpaulins, made from coarse linen soaked in linseed oil. Since then, the legacy of Helly Hansen lives on, developing and creating a long list of first-to-market innovations.

To this day, we continue to make gear that is trusted by professionals around the world. Helly Hansen apparel is developed through the insights of the 55,000 professionals living and working in the world's harshest environments and can be seen on ski patrollers, mountain professionals, world-class sailors, skiers and adventurers.

1949

HELOX - THE NEXT EVOLUTION IN WATERPROOF



1970

LIFA® - THE BIRTH OF TECHNICAL BASE LAYER



1984

HELLY TECH® - THE WATERPROOF AND BREATHABLE SOLUTION

2018

lifa^{loft}

INSULATION BY PRIMALOFT.



2012

H² FLOW™ - A BETTER SOLUTION FOR TEMPERATURE REGULATION

2020

LIFA®INFINITY - THE NEXT LEVEL OF SUSTAINABLE WATERPROOF PERFORMANCE

Helly J. Hansen's

MOSS

1949

HELOX - THE NEXT EVOLUTION IN WATERPROOF

Helox waterproof fabric featured a thin sheet of translucent PVC plastic that was sewn into coats to make them waterproof. It was a revolutionary technology that became the must-have protection for outdoor use. With a production of 30,000 coats each month, the success was almost immediate and was used by the Norwegian delegation at the 1952 Olympic Games in Helsinki.

1961

FIBERPILE - THE TECHNICAL MIDLAYER IS INVENTED

Helly Hansen partnered with Norwegian Fiber Pile Inc. and developed the original Fiberpile – the first fleece. It featured a high warmth to weight ration and maintained its thermal qualities even when wet, making it a favorite of lumberjacks and outdoor enthusiasts. The concept lives on and the modern version of ProPile is still in production today.

1970

LIFA® - THE BIRTH OF TECHNICAL BASE LAYER

HH's LIFA® revolutionized the industry with the introduction of the first technical base layers. LIFA® moves moisture away from the body allowing users to stay warm and comfortable. It has been used by professionals on every ocean, many of the world's tallest peaks and was included in Outside Magazine's list of The Most Influential Gear of All Time in 2012. LIFA® remains the cornerstone of what we believe is the best technical base layer available today.

1984

HELLY TECH® - THE WATERPROOF AND BREATHABLE SOLUTION

Helly Tech® waterproof and breathable fabric was launched in the 1980's, winning awards and setting the new standard for performance and protection. It also provided the final layer for the 1986 introduction of the Helly Hansen 3-Layer System™, an industry-first program educating people on how to dress for the outdoors. Today, Helly Tech® fabrics are engineered to deliver the specific demands of professional's skiers, sailors, and at workplaces around the world.

1990

PROWOOL - THE PERFECT BLEND OF LIFA® AND MERINO

The Prowool (renamed HH® Lifa Merino) baselayer for cold weather conditions was launched in the late 90's, combining Lifa® Stay-Dry Technology™ with Merino wool for both moisture transport and added warmth. Designed for professionals facing the coldest conditions it quickly became the go-to piece for performance, warmth and comfort in extreme environments.

2012

H²FLOW™ - A BETTER SOLUTION FOR TEMPERATURE REGULATION

Helly Hansen introduced the new H2 Flow™ Technology in 2012 with the H2 Flow™ Jacket, which won an Award for Design Excellence from the Norwegian Design Council. The patented H2 Flow™ Jacket features an airflow venting system and a protective barrier. It allows adventurers to efficiently regulate their body temperature.

2018

LIFALOFT™

With increased warmth, lightweight insulation and superior moisture management properties, LIFALOFT™ technology is an insulation revolution that will keep you warmer with less weight and bulk compared to standard polyester insulation. Developed in cooperation with PrimaLoft®, LIFALOFT™ is a combination of LIFA®'s unique insulation structure and PrimaLoft®'s extensive knowledge in synthetic insulation

2020

LIFA® INFINITY PRO™ TECHNOLOGY

The next level of sustainable waterproof performance



FOR THE PEOPLE

The textile and garment industry is made up of a complex supply chain stretched all over the globe. It covers industries such as chemical suppliers, garment manufacturers and cotton crops often situated in countries with weak social regulations.

Helly Hansen has been a member of the Norwegian Ethical Trade organization since 2003 and their main support goes to helping us map our supply chain and engage in projects which improve people's rights and fair payment. Additionally, we have a close relationship with a majority of our Tier 1 and Tier 2 suppliers. Cooperation based on trust and mutual respect has been a part of our core values since the founding of Helly Hansen in 1877. Moreover, our manufacturing code of conduct, which is communicated and signed by all our Tier 1 and Tier 2 suppliers, is based on key UN and International Labor Organization conventions and documents.

We perform social audits on a yearly basis with all our Tier 1 suppliers, including approved sub-contractors. However, to achieve economic and social progress, our main focus is on social dialogue projects. Social dialogue is an integral aspect of achieving workplace harmony, leading to a better organization and greater productivity.

WE SUMMARIZE OUR FOCUS FOR THE PEOPLE IN FOUR MAIN AREAS:

1. Building long-term relationships based on trust and mutual respect.
2. Manufacturing code of conduct communicated and signed by all Tier 1 suppliers, including sub-contractors.
3. Yearly social audits.
4. Enabling "social dialogue" in the workplace to strengthen workers' rights as well as performance and productivity.

SUSTAINABILITY & RESPONSIBILITY

Helly Hansen strongly believes that long term commercial success can only be achieved by respecting, protecting and promoting ethical values, human rights, labor rights and the environment. We continuously work to improve our policies and practices, enabling us and our suppliers to achieve the highest standard in terms of social and environmental values.

We drive improvement for people, and for the planet, working towards making a positive impact on the lives we touch and the environment we are all dependent on protecting.

FOR THE

PLANET

Helly Hansen's DNA is intertwined with water. The brand was founded by a sea captain in 1877 on the Norwegian Fjords and to this day provides professional grade gear for use on water and snow around the world. Our love of water has led us to choose water as our leading sustainability effort. Apparel production uses a lot of water and is a major contributor to water pollution. This is why we will focus our research efforts, our engineering developments and consumer awareness campaigns around ensuring water around the world stays as clean as the Norwegian fjords. We are passionate supporters of many other environmental issues and will continue to be proactive participants in improving the overall standards of the Outdoor Industry but within water issues we will be thought leaders, research pioneers and drive awareness of clean water challenges to our consumers and partners across the value chain.

OUR ENVIRONMENTAL FOCUS AREAS ARE BUILT ON 3 MAIN PILLARS WHERE WE FEEL WE CAN HAVE THE BIGGEST IMPACT:

1. EFFICIENT USE OF WATER, CHEMICALS & ENERGY

- Helly Hansen has been prioritizing bluesign approved materials for over 10 years and today almost 90% of our main fabric is bluesign approved. Bluesign is an in-pur stream management system controlling that only allowed chemistry is applied, as well as it reduces water and energy consumption and air emission on production sites.
- Water consumption has always been a challenge in the textile industry. Here we have been driving change beyond regulations and certifications since the 70's by only using water-free dyeing technologies on our LIFA base layers. We are now adopting these types of technologies on a larger scale, helping us save even more water than before.

2. TRACEABILITY AND TRANSPARENCY

- We are proud of the close cooperation we have with our suppliers and nominate 100% of the materials used in our garments, down to every detail. We also have a relationship with all our material suppliers (Tier 2) which ensures traceability of all the components we are using.
- Helly Hansen has identified the focus materials and chemicals we use requiring full transparency back in the supply chain. Some of the focus materials and chemicals we use are down, wool, PVC, fluorocarbons and flame-retardant treatments.

3. CLOSED LOOP SYSTEMS

- The biggest favour we can do for the environment is to produce less stuff and instead invest in products with quality and longevity. We don't compromise on quality and want our products to be alive for as long as possible. We have stringent quality controls in the laboratory, in production and via field testing with our ambassadors ensuring products that live up to their expectations and beyond.
- Revitalization of materials and products helps us reduce our environmental impact, makes us invest in research and also help adopting existing solutions and technologies related to closed loop models and materials.





MEN'S



MEN'S WINTERSPORT

65713 ICON 4.0 SONIC WELDED STRETCH JACKET USD \$1,100

Sizes: S-2XL
Fitting: Fitted
CB/Inseam:

Insulation: Water column: Weight:

Fabric:
 100% Polyamide

Colours:
 990 Black

- Features:**
- HELLY TECH® Professional fabric
 - 2-layer construction
 - 4-way stretch fabric
 - Ultra sonic welded seams
 - H2Flow™ Air Force Vent System: Mechanical venting for optimal comfort
 - Life pocket+™ with Aerogel Insulation
 - Primaloft® Gold Insulation
 - Body: 100g Sleeves: 80g Hood: Down blend
 - Fully seam sealed
 - Waterproof, windproof and breathable
 - Durable Water Repellency (DWR) treatment



990



HOD

The Hod Collection is inspired by HOD, the Norse God of Winter and our love for skiing. It is experimental with trend right silhouettes, fabrics and new inspirational themes each year. This season is inspired by the 1970's, when innovative fabrics and styles revolutionized skiwear. With bright colors, high-waisted flared pants, faux leather fringes and upgrading with our modern technologies like H2Flow™, Lifa®, Lifepocket™ and LifaLoft™.

65715 AXAMER PUFFY JACKET USD \$1,000

Sizes: S-2XL
Fitting: Regular
CB/Inseam:

Insulation: Water column: Weight:

Fabric:
 100% Polyamide

Colours:
 285 Saffron
 482 Beluga

- Features:**
- Waterproof, windproof and breathable
 - Lightweight 2-layer construction with welded down channels
 - All over foil print
 - Life pocket+™ with Aerogel Insulation
 - Allied® down 600 FP insulation
 - Durable Water Repellency (DWR) treatment
 - RECCO® Advanced Rescue system
 - Articulated sleeves for optimal mobility
 - Detachable powder skirt
 - Helmet compatible hood
 - Detachable hood
 - Dual hand warming pockets



285



482



65714 RUSSI SOFTSHELL STRETCH JACKET USD \$800

Sizes: S-2XL
Fitting: Fitted
CB/Inseam:

Insulation: Water column: Weight:

Fabric:
 74% Polyamide,
 26% Elastane

Colours:
 597 Navy
 639 Electric Blue

- Features:**
- HELLY TECH® Performance
 - 3L knitted stretch softshell
 - 4-way stretch fabric
 - H2Flow™ Technology
 - Life pocket+™ with Aerogel Insulation
 - Primaloft® Gold Insulation
 - Body: 80g Sleeves: 80g Hood: Down blend
 - Allied® Down in collar
 - Fully seam sealed
 - Waterproof, windproof and breathable
 - Durable Water Repellency (DWR) treatment
 - Laser cut exterior air ports at back yoke
 - RECCO® Advanced Rescue system



597



639



65716 TRICOLORE INSULATED JACKET USD \$700

Sizes: S-2XL
Fitting: Regular
CB/Inseam:

Insulation: Water column: Weight:

Fabric:
 70% Polyamide,
 30% Polyester

Colours:
 285 Saffron
 639 Electric Blue
 857 Pelican

- Features:**
- HELLY TECH® Performance
 - Mélange ripstop fabric
 - Embossed lining in body and velvet lining in collar
 - H2Flow™ Technology
 - Life pocket+™ with Aerogel Insulation
 - Primaloft® Down blend Insulation
 - Fully seam sealed
 - Waterproof, windproof and breathable
 - Durable Water Repellency (DWR) treatment
 - RECCO® Advanced Rescue system
 - Articulated sleeves for optimal mobility
 - Detachable powder skirt with YKK® zipper



285



639



857



MEN'S WINTERSPORT



65719 TRICOLORE QUILTED INSULATOR JACKET USD \$300



Sizes: S-2XL
Fitting: Fitted
CB/Inseam:

Insulation:
Water column:
Weight:

Fabric:

Shell: 100% Polyamide - Lining: 100% Polyester - Insulation: 55% Recycled Polyester, 45% Polyester

Colours:

597 Navy
 639 Electric Blue

Features:

- Primaloft® Gold insulation 80g
- 30 denier windproof and water resistant fabric
- PFC free DWR
- Stretch lining for added comfort
- Elastic striped rib at bottom hem and sleeve and collar
- Two hand warming pockets
- YKK® Auto lock center front zipper



597



639

65720 TRICOLORE KNITTED SWEATER USD \$200



Sizes: S-2XL
Fitting: Fitted
CB/Inseam:

Insulation:
Water column:
Weight:

Fabric:

Shell: 65% Wool, 35% Polyamide

Colours:

001 White
 285 Saffron
 597 Navy

Features:

- Premium Merino wool yarn
- Plain knit construction in body
- Ottoman elbow rib for added movement
- 1x1 rib at bottom hem and sleeve and collar
- Felt badge on arm
- 1/2 zip



001



285



597

MEN'S WINTERSPORT

65717 ICON 4.0 SONIC WELDED PANT

USD \$550



Sizes: S-2XL
Fitting: Fitted
CB/Inseam:

Insulation:
Water column:
Weight:

Fabric:
 100% Polyamide

Colours:
 597 Navy
 990 Black

- Features:**
- HELLY TECH® Professional fabric
 - 2-layer construction
 - Waterproof, windproof and breathable
 - 4-way stretch fabric
 - Ultra sonic welded seams
 - Adjustable waist
 - RECCO® Advanced Rescue system
 - SKI FREE
 - Inner thigh ventilation zippers
 - Durable Water Repellency (DWR) treatment
 - Boot gaiters with stretch silicone gripper
 - Bemis Reinforcement fabric on bottom hem



597



990

65718 RUSSI SOFTSHELL STRETCH PANT

USD \$400



Sizes: S-2XL
Fitting: Fitted
CB/Inseam:

Insulation:
Water column:
Weight:

Fabric:
 74% Polyamide,
 26% Elastane

Colours:
 226 Bright Orange
 597 Navy

- Features:**
- Waterproof, windproof and breathable
 - 3L knitted stretch softshell
 - 4-way stretch fabric
 - Embossed lining
 - RECCO® Advanced Rescue system
 - SKI FREE
 - Inner thigh ventilation zippers
 - Durable Water Repellency (DWR) treatment
 - Boot gaiters with stretch silicone gripper
 - Bemis Reinforcement fabric on bottom hem
 - Dual hand warming pockets
 - Belt loops
 - Elastic adjustable waist



226



597

65738 STEILHANG JACKET

USD \$700

Sizes: S-2XL
Fitting: Regular
Water column: 11000/7100
Weight:

Fabric:
 Shell: 85% Polyamide,
 15% Elastane
 - Shell 2: 91% Polyamide, 9% Elastane - Lining:
 86% Polyester,
 14% Elastane -
 Insulation body:
 80% Recycled Polyester,
 20% Polyester -
 Insulation: 80% Recycled Polyester,
 20% Polyester -
 Insulation:

Colours:
 222 Alert Red
 421 Lav Green
 983 Slate
 990 Black

- Features:**
- HELLY TECH® Professional fabric
 - 2-layer fabric construction
 - 4-way stretch fabric
 - H2Flow™ Air Force Vent System: Mechanical venting for optimal comfort
 - Life pocket+™ with Aerogel® Insulation
 - SKI FREE
 - Fold away hi vis brim
 - Fully seam sealed
 - Waterproof, windproof and breathable
 - Durable Water Repellency (DWR) treatment
 - Primaloft® Black Eco Insulation
 - Body: 80g Sleeves: 60g Hood: Down blend
 - Fully insulated



222

Articulated Sleeves for optimal mobility

Fold away hi vis brim

HELLY TECH® Professional Fabric

H2Flow™ Air Force Ventilation Technology

Recco® Advanced Rescue System

YKK® Aqua guard® Vislon water resistant zippers

Life Pocket™ with Aerogel Insulation



990



983



421

RESORT

A sharp classic ski design integrated into performance ski apparel with proven technologies and innovations to give confidence every day on the mountain.



65689 RIVARIDGE PUFFY JACKET

USD \$550

Sizes: S-2XL
Fitting: Regular
CB/Inseam: 78cm

Insulation: Water column: 20000
Weight:

Fabric:
 Face: 89% Polyamide, 11% Elastane / Back: 100% Polyurethane

Colours: 300 Patrol Orange, 597 Navy, 990 Black

Features:

- HELLY TECH® Professional fabric
- 2-layer fabric construction
- 4-way stretch fabric
- Welded down channels
- H2Flow™ Technology
- Life Pocket+™ with AeroGel Insulation
- Fully seam sealed
- Waterproof, windproof and breathable
- Durable Water Repellency (DWR) treatment
- Fully insulated with Primaloft® Down blend
- RECCO® Advanced Rescue system



300



597



990

65667 ALPHA LIFALOFT JACKET

USD \$550

Sizes: S-2XL
Fitting: Regular
CB/Inseam: 75,5 cm

Insulation: LIFALOFT™ 80g insulation
Water column: 20000
Weight:

Fabric: 85% Polyamide, 15% Elastane

Colours: 300 Patrol Orange, 421 Lav Green, 599 Navy, 639 Electric Blue, 990 Black

Features:

- HELLY TECH® Professional fabric
- 2-layer fabric construction
- 4-way stretch fabric
- LIFALOFT™ insulation by Primaloft® 80g
- Life pocket+™ with AeroGel® Insulation
- SKI FREE
- Fold away hi vis brim
- Fully seam sealed
- Waterproof, windproof and breathable
- Durable Water Repellency (DWR) treatment

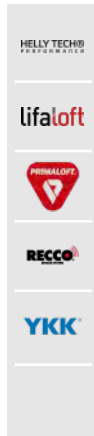

300



421



599



639



990

65551 ALPHA 3.0 JACKET

USD \$475

Sizes: S-2XL
Fitting: Fitted
CB/Inseam: 75,5 cm

Insulation: Water column: 20000
Weight:

Fabric: Face: 85% Polyamide, 15% Elastane / Back: 100% Polyurethane

Colours: 222 Alert Red, 488 Scarab Green, 597 Navy, 639 Electric Blue, 983 Slate, 990 Black

Features:

- HELLY TECH® Professional fabric
- 2-layer fabric construction
- 4-way stretch fabric
- H2Flow™ Technology
- Life pocket™ with Primaloft® Insulation
- SKI FREE
- Fold away hi vis brim
- Fully seam sealed
- Waterproof, windproof and breathable
- Durable Water Repellency (DWR) treatment
- Primaloft® Gold Insulation in body
- Primaloft® Black Hi-Loft 80g in sleeves and hood



222



990



488



597



639



983

65739 OMEGA JACKET

USD \$400

Sizes: S-2XL
Fitting: Regular
CB/Inseam:

Insulation: Water column: 20000
Weight:

Fabric: Shell: 85% Polyamide, 15% Elastane

Colours: 001 White, 482 Beluga Nmm, Map Print, 597 Navy, 983 Slate, 990 Black

Features:

- HELLY TECH® Professional fabric
- 2-layer fabric construction
- 4-way stretch fabric
- H2Flow™ Technology
- Life pocket™ with Primaloft® Insulation
- SKI FREE
- Fold away hi vis brim
- Fully seam sealed
- Waterproof, windproof and breathable
- Durable Water Repellency (DWR) treatment
- Primaloft® Black Insulation in body
- Primaloft® Black Hi-Loft 80g in sleeves and hood



001



482



597



983



990



65740 FREEWAY JACKET

USD \$400

Sizes: S-2XL
Fitting: Regular
CB/Inseam:

Insulation:
Water column: 11000/7100
Weight:

Fabric:
 Shell: 85%
 Polyamide, 15%

Colours:
 222 Alert Red
 421 Lav Green
 983 Slate
 990 Black

- Features:**
- HELLY TECH® Professional fabric
 - 2-layer fabric construction
 - 4-way stretch fabric
 - H2Flow™ Technology
 - Life pocket™ with Primaloft® Insulation
 - SKI FREE
 - Fold away hi vis brim
 - Fully seam sealed
 - Waterproof, windproof and breathable
 - Durable Water Repellency (DWR) treatment
 - Primaloft® Black Insulation in body
 - Primaloft® Black Hi-Loft 80g in sleeves and hood



222



421



983



990

65741 RIVA LIFALOFT JACKET

USD \$375

Sizes: S-2XL
Fitting: Regular
CB/Inseam:

Insulation:
Water column: 14700/10470
Weight:

Fabric:
 Shell: 100%
 Polyester

Colours:
 300 Patrol Orange
 421 Lav Green
 639 Electric Blue
 990 Black

- Features:**
- HELLY TECH® Performance
 - 2-layer fabric construction
 - 2-way stretch fabric
 - Life pocket™ with Primaloft® Insulation
 - SKI FREE
 - Fully seam sealed
 - Waterproof, windproof and breathable
 - Durable Water Repellency (DWR) treatment
 - LIFALOFT™ insulation by Primaloft®
 - Fully insulated
 - RECCO® Advanced Rescue system
 - Articulated sleeves for optimal mobility
 - Detachable powder skirt



300



421



639



990

65598 JUNIPER 3.0 JACKET

USD \$400

Sizes: S-2XL
Fitting: Regular
CB/Inseam: 82cm

Insulation:
Water column: 10000
Weight:

Fabric:
 Face: 100%
 Polyester / Back:
 100% Polyurethane

Colours:
 223 Alert Red
 482 Beluga
 597 Navy
 983 Slate
 990 Black

- Features:**
- 2-layer fabric construction
 - 2-way stretch fabric in mélange
 - H2Flow™ Technology
 - Life pocket™
 - SKI FREE
 - Fully seam sealed
 - Waterproof, windproof and breathable
 - Durable Water Repellency (DWR) treatment
 - Fully insulated
 - Articulated sleeves for optimal mobility
 - Helmet compatible hood
 - Detachable hood
 - Adjustable hood



223



482



597



983



990

65599 SWIFT 4.0 JACKET

USD \$350

Sizes: S-2XL
Fitting: Regular
CB/Inseam: 80cm

Insulation:
Water column: 10000
Weight:

Fabric:
 Face: 100%
 Polyester / Back:
 100% Polyurethane

Colours:
 300 Patrol Orange
 421 Lav Green
 639 Electric Blue
 991 Black

- Features:**
- 2-layer fabric construction
 - 4-way stretch fabric
 - Life pocket™
 - SKI FREE
 - Fully seam sealed
 - Waterproof, windproof and breathable
 - Durable Water Repellency (DWR) treatment
 - Fully insulated
 - RECCO® Advanced Rescue system
 - Articulated sleeves for optimal mobility
 - Detachable powder skirt
 - Helmet compatible hood
 - Detachable hood



300



421



639



991

65743 GRAVITATION JACKET

USD \$300

Sizes: S-2XL
Fitting: Regular
CB/Inseam:

Insulation:
Water column: 25300/27710
Weight:

- Fabric:**
Shell: 100% Polyester - Shell
2: 100% Polyester - Lining: 100% Polyamide -
Insulation: 80% Recycled Polyester, 20% Polyester
- Colours:**
300 Patrol Orange
488 Scarab Green
597 Navy
- Features:**
- HELLY TECH® Performance
 - 2-layer fabric construction
 - 2-way stretch fabric
 - Life pocket™ with Primaloft® Insulation
 - SKI FREE
 - Fully seam sealed
 - Waterproof, windproof and breathable
 - Durable Water Repellency (DWR) treatment
 - Primaloft® Black Eco insulation 80g
 - Fully insulated
 - RECCO® Advanced Rescue system
 - Articulated sleeves for optimal mobility
 - Detachable powder skirt



65761 ALPHA LIFALOFT™ PANT

USD \$350

Sizes: S-2XL
Fitting: Regular
CB/Inseam:

Insulation:
Water column: 11000/7100
Weight:

- Fabric:**
Shell: 85% Polyamide, 15% Elastane
- Colours:**
300 Patrol Orange
488 Scarab Green
597 Navy
990 Black
- Features:**
- HELLY TECH® Professional fabric
 - 2-layer fabric construction
 - 4-way stretch fabric
 - LIFALOFT™ insulation by Primaloft®
 - SKI FREE
 - Outer thigh ventilation zippers
 - Fully seam sealed
 - Waterproof, windproof and breathable
 - Durable Water Repellency (DWR) treatment
 - Fully insulated
 - RECCO® Advanced Rescue system
 - Boot gaiters with stretch silicone gripper
 - Bemis OT Reinforcement at bottom hem and edge protection



65762 RAPID PANT

USD \$275

Sizes: S-2XL
Fitting: Regular
CB/Inseam:

Insulation:
Water column:
Weight:

- Fabric:**
Shell: 85% Polyamide, 15% Elastane - Lining: 86% Polyester, 14% Elastane - Lining 2: 100% Polyester - Insulation: 70% Recycled Polyester, 30% Polyester
- Colours:**
222 Alert Red
421 Lav Green
983 Slate
990 Black
- Features:**
- HELLY TECH® Professional fabric
 - 2-layer fabric construction
 - 4-way stretch fabric
 - Primaloft® Silver insulation 40g
 - SKI FREE
 - Outer thigh ventilation zippers
 - Fully seam sealed
 - Waterproof, windproof and breathable
 - Durable Water Repellency (DWR) treatment
 - Fully insulated
 - RECCO® Advanced Rescue system
 - Boot gaiters with stretch silicone gripper
 - Bemis OT Reinforcement at bottom hem and edge protection



65704 LEGENDARY INSULATED PANT

USD \$200

Sizes:
Fitting:
CB/Inseam: 86 cm

Insulation:
Water column:
Weight:

- Fabric:**
Face: 100% Polyester / Back: 100% Polyurethane
- Colours:**
222 Alert Red
226 Bright Orange
402 Azid Lime
482 Beluga NMM
597 Navy
983 Slate
990 Black
- Features:**
- HELLY TECH® Performance
 - Waterproof, windproof and breathable
 - 2-layer fabric construction
 - 2-way stretch fabric
 - Fully seam sealed
 - Primaloft® Black Insulation 60g
 - Fully insulated
 - Durable Water Repellency (DWR) treatment
 - Inner thigh ventilation zippers
 - Articulated knees for optimal mobility
 - Boot gaiters with silicone gripper
 - Reinforcement on bottom leg
 - Dual hand pockets



65772 ELEVATION INFINITY SHELL JACKET

USD \$750



Sizes: XS-2XL
Fitting: Relaxed
CB/Inseam:

Insulation: Water column: 13000/18000
Weight:

Fabric: 100% Polypropylene

Colours: 853 Grey Fog

- Features:**
- LIFA® Infinity Pro™
 - 3-layer fabric construction shell jacket
 - Ultra sonic welded seams
 - Life pocket+™ with Aerogel Insulation
 - Hi vis hood brim
 - Fully seam sealed
 - Waterproof, windproof and breathable
 - Durable Water Repellency (DWR) treatment
 - Under arm ventilation zippers
 - RECCO® Advanced Rescue system
 - Fusion modular system jacket to pant
 - Articulated sleeves for optimal mobility
 - Detachable powder skirt



853

ULLR

Our freeride collection is developed and tested in collaboration with our Helly Hansen free skiing professionals around the world.

65745 ULLR CHUGACH POWDER SUIT

USD \$900



Sizes: S-2XL
Fitting: Relaxed
CB/Inseam:

Insulation: Water column: Weight:

Fabric: Shell: 71% Polyamide, 29% Polyester - Shell 2: 71% Polyamide, 29% Polyester

Colours: 300 Patrol Orange
458 Uniform Green

- Features:**
- HELLY TECH® Professional fabric
 - 3 ply fabric construction
 - Durable mélange ripstop fabric
 - Hi vis hood and details for safety
 - Life pocket+™ with Primaloft® Aerogel Insulation
 - Fully seam sealed
 - Durable Water Repellency (DWR) treatment
 - Waterproof, windproof and breathable
 - Mechanical ventilation zippers
 - RECCO® Advanced Rescue system
 - Helmet compatible hood



300



458

65746 ELEVATION SHELL 3.0 JACKET

USD \$650



Sizes: S-2XL
Fitting: Relaxed
CB/Inseam:

Insulation: Water column: Weight:

Fabric: 71% Polyamide, 29% Polyester

Colours: 458 Uniform Green
983 Slate

- Features:**
- HELLY TECH® Professional fabric
 - 3-layer fabric construction shell jacket
 - Durable mélange ripstop fabric
 - Life pocket+™ with Aerogel Insulation
 - Hi vis hood
 - Ultra sonic seams for more comfort
 - Fully seam sealed
 - Waterproof, windproof and breathable
 - Durable Water Repellency (DWR) treatment
 - Under arm ventilation zippers
 - RECCO® Advanced Rescue system
 - Fusion modular system jacket to pant
 - Articulated sleeves for optimal mobility
 - Detachable powder skirt



458



983

65610 RIDGE SHELL 2.0 JACKET

USD \$550



Sizes: XS-2XL
Fitting: Relaxed
CB/Inseam: 83cm

Insulation: **Water column:** 20000
Weight:

Fabric:
 Face: 100% Polyester / Back: 100% Polyurethane

Colours:
 300 Patrol Orange
 458 Uniform Green
 639 Electric Blue

Features:

- 3-layer fabric construction
- Life pocket+™ with Aerogel Insulation
- SKI FREE
- Hi vis hood brim
- Fully seam sealed
- Waterproof, windproof and breathable
- Durable Water Repellency (DWR) treatment
- Under arm ventilation zippers
- RECCO® Advanced Rescue system
- Fusion modular system jacket to pant
- Articulated sleeves for optimal mobility
- Detachable powder skirt
- Helmet compatible hood with adjustment



300



458



639



65747 GARIBALDI 2.0 JACKET

USD \$450



Sizes: S-2XL
Fitting: Relaxed
CB/Inseam:

Insulation: **Water column:** **Weight:**

Fabric:
 Shell: 70% Polyamide, 30% Polyester - Shell: 100% Polyester - Insulation body: 80% Recycled Polyester, 20% Polyester

Colours:
 458 Uniform Green
 793 Redwood
 983 Slate

Features:

- HELLY TECH® Professional fabric
- 2-layer construction
- Mélange fabric
- Life pocket+™ with Aerogel Insulation
- Hi vis hood brim
- H2Flow™ Technology
- Primaloft® Black Eco Insulation 60g in body, 40g in sleeves and hood
- Fully seam sealed
- Waterproof, windproof and breathable
- Durable Water Repellency (DWR) treatment
- Under arm side ventilation zippers
- RECCO® Advanced Rescue system



458



793



983

65670 FIRSTTRACK LIFALOFT™ JACKET

USD \$425



Sizes: XS-L
Fitting: Relaxed
CB/Inseam: 87cm

Insulation: LIFALOFT™ 133g insulation
Water column: 20000
Weight:

Fabric:
 Face: 100% Polyester / Back: 100% Polyurethane

Colours:
 300 Patrol Orange
 380 Antique Moss
 639 Electric Blue

Features:

- HELLY TECH® Professional fabric
- 2-layer fabric construction
- 2-way stretch fabric
- Fully insulated with 133g LIFALOFT™ Insulation and brushed stretch panels for added breathability
- Life pocket™
- Hi vis hood brim
- Fully seam sealed
- Waterproof, windproof and breathable
- Durable Water Repellency (DWR) treatment



300



380



639

65748 SOGN SHELL 2.0 JACKET

USD \$350



Sizes: S-2XL
Fitting: Relaxed
CB/Inseam:

Insulation: **Water column:** **Weight:**

Fabric:
 Shell: 100% Polyamide

Colours:
 300 Patrol Orange
 380 Antique Moss
 597 Navy
 639 Electric Blue

Features:

- HELLY TECH® Professional fabric
- 3 ply fabric construction
- Matte shell fabric
- Life Pocket™
- Hi-vis hood brim
- Fully seam sealed
- Waterproof, windproof and breathable
- Durable Water Repellency (DWR) treatment
- RECCO® Advanced Rescue system
- Fusion modular system jacket to pant
- Articulated sleeves for optimal mobility
- Attached powder skirt



300



380



597



639

65671 STRAIGHTLINE JACKET

USD \$375

- Sizes:** XS-2XL
Fitting: Relaxed
CB/Inseam: 87cm
- Insulation:** LIFALOFT™ 80g insulation
Water column: 20000
Weight:
- Fabric:**
 Face: 100% Polyamide / Back: 100% Polyurethane
- Colours:**
 458 Uniform Green
 639 Electric Blue
 980 Ebony
 983 Slate
- Features:**
- HELLY TECH® Professional fabric
 - 2-layer fabric construction
 - Fully insulated with 80g LIFALOFT™™ Insulation and brushed stretch panels for added breathability
 - Life pocket™
 - Hi vis hood brim
 - Fully seam sealed
 - Waterproof, windproof and breathable
 - Durable Water Repellency (DWR) treatment
 - Under arm ventilation zippers
 - RECCO® Advanced Rescue system



65749 KICKINGHORSE JACKET

USD \$300

- Sizes:** S-2XL
Fitting: Relaxed
CB/Inseam:
- Insulation:**
Water column:
Weight:
- Fabric:**
 Shell: 100% Polyester - Lining: 100% Polyamide
 - Insulation body: 80% Recycled Polyester, 20% Polyester -
 Insulation sleeves: 80% Recycled Polyester, 20% Polyester
- Colours:**
 458 Uniform Green
 793 Redwood
 990 Black New
- Features:**
- HELLY TECH® Performance
 - 2-layer construction
 - Durable texturized fabric
 - Fully seam sealed
 - Waterproof, windproof and breathable
 - Durable Water Repellency (DWR) treatment
 - Primaloft® 60g Insulation
 - Under arm ventilation zippers
 - RECCO® Advanced Rescue system
 - Fusion modular system jacket to pant
 - Articulated sleeves for optimal mobility
 - Attached powder skirt
 - Helmet compatible hood with adjustment



65751 ELEVATION SHELL 3.0 PANT

USD \$475

- Sizes:** S-2XL
Fitting: Relaxed
CB/Inseam:
- Insulation:**
Water column:
Weight:
- Fabric:**
 Shell: 71% Polyamide, 29% Polyester
- Colours:**
 300 Patrol Orange
 983 Slate
- Features:**
- HELLY TECH® Professional fabric
 - 3-layer fabric construction
 - Durable mélange ripstop fabric
 - SKI FREE
 - Bemis Reinforcement on bottom leg
 - Fully seam sealed
 - Waterproof, windproof and breathable
 - Durable Water Repellency (DWR) treatment
 - Back thigh ventilation zippers
 - RECCO® Advanced Rescue system
 - Articulated construction at seat and knee for superior fit
 - Attached stretch snow gaiters



65616 RIDGE SHELL PANT

USD \$400

- Sizes:** XS-2XL
Fitting: Relaxed
CB/Inseam: 79,5cm
- Insulation:**
Water column: 20000
Weight:
- Fabric:**
 Face: 100% Polyester / Back: 100% Polyurethane
- Colours:**
 380 Antique Moss
 597 Navy
 983 Slate
- Features:**
- 3-layer fabric construction
 - SKI FREE
 - Reinforcement on bottom leg
 - Fully seam sealed
 - Waterproof, windproof and breathable
 - Durable Water Repellency (DWR) treatment
 - Back thigh ventilation zippers
 - RECCO® Advanced Rescue system
 - Articulated construction at seat and knee for superior fit
 - Attached stretch snow gaiters
 - Dual hip pockets, left thigh pocket with water secure bellow construction



65574 SOGN BIB SHELL PANT

USD \$350



Sizes: XS-2XL
Fitting: Regular
CB/Inseam: 85cm

Insulation: 20000
Water column: 20000
Weight:

Fabric:
Face: 100% Polyamide / Back: 100% Polyester

Colours:
793 Redwood
991 Black

- Features:**
- HELLY TECH® Professional fabric
 - 3 ply fabric construction
 - SKI FREE
 - Beacon specific pocket
 - Adjustable suspenders
 - Fully Seam sealed
 - Mechanical vent zippers on back thigh
 - Boot gaiters with stretch silicone gripper
 - Reinforcement fabric on bottom hem
 - Waterproof, windproof and breathable
 - Durable Water Repellency (DWR) treatment
 - Hi vis details



793



991



65758 GARIBALDI 2.0 PANT

USD \$300



Sizes: S-2XL
Fitting: Relaxed
CB/Inseam:

Insulation:
Water column:
Weight:

Fabric:
Shell: 100% Polyester - Lining: 100% Polyamide

Colours:
458 Uniform Green
639 Electric Blue
980 Ebony
983 Slate

- Features:**
- HELLY TECH® Professional fabric
 - 2-layer construction
 - Jacquard texturized fabric
 - Drop liner with brushed seat and knee
 - Reinforcement fabric on bottom leg
 - Fully seam sealed
 - Waterproof, windproof and breathable
 - Durable Water Repellency (DWR) treatment
 - Back thigh ventilation zippers
 - RECCO® Advanced Rescue system
 - Articulated construction at seat and knee for superior fit
 - Attached snow gaiters



458



639



980



983

65673 SOGN CARGO PANT

USD \$200



Sizes: XS-2XL
Fitting: Relaxed
CB/Inseam: 86,5cm

Insulation: 5000
Water column:
Weight:

Fabric:
Face : 100% Polyamide / Back : 100% Polyurethane

Colours:
300 Patrol Orange
482 Beluga Nmm
Map Print
597 Navy
983 Slate
991 Black

- Features:**
- HELLY TECH® Protection
 - Waterproof, windproof and breathable
 - 2-layer fabric construction
 - Structured fabric
 - Primaloft® Seat and knee insulation
 - Fully seam sealed
 - Durable Water Repellency (DWR) treatment
 - Inner thigh ventilation zippers
 - RECCO® Advanced Rescue system
 - Articulated knees
 - Boot gaiters with silicone gripper
 - Reinforcement fabric on bottom hem
 - Dual hand pockets and cargo pocket with D-ring for beacon



300



482



597



983



991

MEN'S WINTERSPORT

65674 LIFALOFT HOODED STRETCH INSULATOR USD \$280

Sizes: XS-2XL
Fitting: Fitted
CB/Inseam: 74.5

Insulation: LIFALOFT™ 80g insulation

Fabric: 91% Polyamide, 9% Elastane

Colours: 300 Patrol Orange
 380 Antique Moss
 639 Electric Blue
 990 Black

Water column:
Weight:

Features:

- LIFALOFT™ insulation by Primaloft®
- 4 way stretch fabric
- Fiber and down proof fabric construction
- Durable Water Repellency (DWR) treatment
- Life Pocket™
- Articulated sleeves for optimal mobility
- Full inner front zipper placket for wind protection
- Hand warming pockets
- Adjustable hem with drawcord
- Hood for under helmet
- HH® LIFALOFT™ logo at front left chest



300



380



639



990

LIFALOFT™
 Lightweight warmth for all seasons. 20% lighter and still warmer than standard insulation.

65604 LIFALOFT HOODED INSULATOR JACKET USD \$220

Sizes: XS-2XL
Fitting: Regular
CB/Inseam: 74,5 cm

Insulation: LIFALOFT™ 80g insulation

Fabric: 100% Polyamide

Colours: 380 Antique Moss
 598 Navy
 639 Electric Blue
 793 Redwood
 983 Slate
 991 Black Matte

Water column:
Weight:

Features:

- LIFALOFT™ insulation by Primaloft®
- Water resistant and windproof fabric
- Fiber and down proof fabric construction
- Durable Water Repellency (DWR) treatment
- Full inner front zipper placket for wind protection
- HH® LIFALOFT™ logo at front left chest



380



991



598



639



793



983

65603 LIFALOFT INSULATOR JACKET USD \$200

Sizes: XS-2XL
Fitting: Regular
CB/Inseam: 74 cm

Insulation: LIFALOFT™ 80g insulation

Fabric: 100% Polyamide

Colours: 222 Alert Red
 380 Antique Moss
 482 Beluga Nmm Print
 483 Beluga
 597 Navy
 983 Slate
 991 Black Matte

Water column:
Weight:

Features:

- LIFALOFT™ insulation by Primaloft®
- Water resistant and windproof fabric
- Fiber and down proof fabric construction
- Durable Water Repellency (DWR) treatment
- Full inner front zipper placket for wind protection
- HH® LIFALOFT™ logo at front left chest



222



983



991



380



482



483



597

65605 LIFA LOFT HYBRID INSULATOR JACKET USD \$185

Sizes: XS-2XL
Fitting: Regular
CB/Inseam: 74,5 cm

Insulation: LIFALOFT™ 80g insulation

Fabric: 100% Polyamide

Colours: 482 Beluga Nmm Print
 483 Beluga
 598 Navy
 991 Black

Water column:
Weight:

Features:

- LIFALOFT™ insulation by Primaloft®
- Water resistant and windproof fabric
- Fiber and down proof fabric construction
- Durable Water Repellency (DWR) treatment
- Slick face stretch fabric
- Full inner front zipper placket for wind protection
- HH® LIFALOFT™ logo at front left chest



482



483



598



991

65606 LIFALOFT INSULATOR VEST

USD \$150

- Sizes:** S-2XL
Fitting: Regular
CB/Inseam: 74 cm
- Insulation:** LIFALOFT™ 80g insulation
Water column:
Weight:
- Fabric:** 100% Polyamide
- Colours:** 597 Navy, 793 Redwood, 991 Black
- Features:**
- LIFALOFT™ insulation by Primaloft®
 - Water resistant and windproof fabric
 - Fiber and down proof fabric construction
 - Durable Water Repellency (DWR) treatment
 - Hand pockets with brushed lining
 - YKK® zip closure
 - Full inner front zipper placket for wind protection
 - Lycra edge band around collar for clean finish
 - HH® LIFALOFT™ logo at front left chest



597

793

991

65702 LIFALOFT FULL ZIP INSULATOR

USD \$160

- Sizes:** S-2XL
Fitting: Regular
CB/Inseam: 48cm
- Insulation:** LIFALOFT™ 80g insulation
Water column:
Weight:
- Fabric:** 100% Polyamide
- Colours:** 991 Black
- Features:**
- LIFALOFT™ insulation by Primaloft®
 - Water resistant and windproof fabric
 - Fiber and down proof fabric construction
 - PFC Free Durable Water Repellency (DWR) treatment
 - YKK® Center front zipper and dual YKK® zipped hand warmer pockets.
 - Full side zipper for easy on and off
 - Snap buttons for secure closure
 - Placket behind zipper for added wind protection
 - Back pocket
 - Stretch panels for optimized fit



991

LIGHTWEIGHT WARMTH FOR ALL SEASONS
 20% LIGHTER AND STILL WARMER THAN
 STANDARD INSULATION.

lifaloft
 INSULATION BY PRIMALOFT.



63046 ODIN INFINITY SHELL JACKET USD \$700

Sizes: S-2XL
Fitting: Regular
CB/Inseam: 80cm

Insulation: **Water column:** 16000 / 24000
Weight:

Features:

- LIFA® Infinity Pro™ Technology
- 3-layer fabric construction
- Polypropylene microporous membrane
- Solution dyed face fabric
- 100% polyester tricot backing
- Waterproof, Windproof and breathable
- Helmet, backpack and harness compatible construction and pockets
- Detachable powder skirt
- Vertical and horizontal hood adjustments
- Laminated brim with flat contrast piping and double cord brim shape
- Mechanical ventilation zippers
- Molded cuff tabs with Odin sign off

Fabric: 100% Polypropylene

Colours:

PR



Vertical and horizontal hood adjustments

Polypropylene microporous membrane

Lifa® Infinity Pro™ Technology

Solution Dyed Face fabric

Recco® Advanced Rescue system

Helmet, Backpack and harness compatible construction and pockets

990

ODIN

Inspired by Norse mythology, the Odin series is developed with and tested by mountain guides around the world to achieve the most complete and purposeful weather protection.



62901 ODIN MOUNTAIN 3L SHELL JACKET USD \$600

Sizes: S-2XL
Fitting: Regular
CB/Inseam: 81,5cm

Insulation: **Water column:** 20000/20000
Weight:

Features:

- HELLY TECH® Professional Allied® Down 800FP 90/10 Goose Down
- LIFALOFT™ insulation by Primaloft® 80g
- 7D down proof main fabric
- C6 DWR
- Bluesign® approved fabric
- Double down baffle construction to avoid cold spots
- Lightweight & breathable
- Packable into stuff sack
- Body mapped construction for optimal advantage of down and LIFALOFT™ insulation by Primaloft® properties

Fabric: Face: 100% Polyamide / Back: 100% Polyamide
Colours: 639 Electric Blue, 793 Redwood, 983 Slate

HELLY TECH® PROFESSIONAL



793



639



983



62902 ODIN MOUNTAIN 3L SHELL BIB PANT USD \$475

Sizes: S-2XL
Fitting: Regular
CB/Inseam: 86cm

Insulation: **Water column:** 20000/20000
Weight:

Features:

- HELLY TECH® Professional fabric
- 3-layer lightweight fabric construction
- C6 DWR and Microporous membrane
- 100% polyamide face and back with woven backing
- 20,000gm WP & 20,000gm MVP
- Waterproof, Windproof and breathable
- Softshell bib construction with 11 degree angle pocket and integrated D-ring for beacon attachment
- Elastic suspenders that hook off in front
- Right thigh pocket with integrated D-ring for beacon attachment

Fabric: Face: 100% Polyamide / Back: 100% Polyamide
Colours: 300 Patrol Orange, 990 Black

HELLY TECH® PROFESSIONAL



300



990





MEN'S MOUNTAIN

62903 ODIN MOUNTAIN SOFTSHELL JACKET

USD \$325



Sizes: S-2XL
Fitting: Regular
CB/Inseam: 81,5cm

Insulation:
Water column:
Weight:

Fabric:

Face: 82%
 Polyamide, 18%
 Elastane / Back:
 100% Polyester

Colours:

611 Blue Mountain
 793 Redwood
 990 Black

Features:

- 4-way stretch softshell fabric
- C6 DWR
- Hybrid construction with membrane fabric at top for weather protection and no-membrane fabric on body for maximum breathability
- Grid fleece backing for optimal performance and comfort
- Windproof and breathable
- Vertical and horizontal hood adjustment
- Laminated brim with flat contrast piping and double cord brim shape
- Hand pocket behind flap
- Molded cuff tabs with Odin sign off



611



793



990

62904 ODIN MOUNTAIN SOFTSHELL PANT

USD \$300



Sizes: S-2XL
Fitting: Regular
CB/Inseam: 86cm

Insulation:
Water column:
Weight:

Fabric:

Face: 82%
 Polyamide, 18%
 Elastane / Back:
 74% Polyester, 26%
 Bamboo

Colours:

793 Redwood
 990 Black

Features:

- 4-way stretch softshell fabric
- 4-way stretch softshell fabric
- C6 DWR
- Hybrid construction with membrane fabric at front leg up to knee and back seat for weather protection, and no-membrane fabric for maximum breathability
- Slick feel backing for optimal performance and comfort
- Windproof and breathable
- Right side thigh pocket with water resistant zipper and integrated D-ring for beacon attachment



990



793

62997 ODIN LIFALOFT DOWN HYBRID JACKET

USD \$400



Sizes: S-2XL
Fitting: Regular
CB/Inseam:

Insulation: Water column: Weight:
Features:
 • LIFALOFT™ insulation by Primaloft®80g
 • Allied® Down 800FP 90/10 Goose Down
 • 7D down proof main fabric
 • C6 DWR
 • Bluesign® approved fabric
 • Dual down baffle construction for maximum warmth and no cold spots
 • Lightweight & breathable
 • Packable into stuff sack
 • Body mapped construction for optimal advantage of Down and LIFALOFT™ properties
 • Warm when wet, warm when cold

Fabric:
 100% Polyamide

Colours:
 300 Patrol Orange
 990 Black

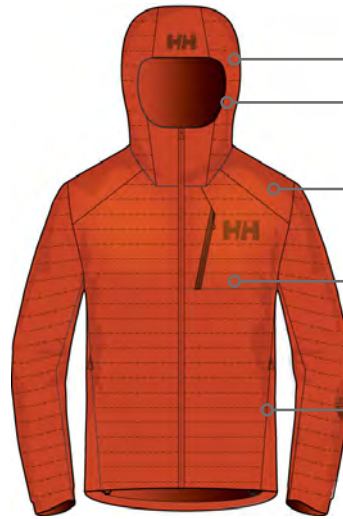

LIFALOFT™
 ALLIED Down
 Dual down baffle construction for maximum warmth and no cold spots
 Body mapped construction for optimal advantage of LIFALOFT™ and Down properties
 Packable into stuff sack



Warmth when you need it

300

990

62938 ODIN 9 WORLDS 2.0 JACKET

USD \$400



Sizes: S-2XL
Fitting: Regular
CB/Inseam: 75cm

Insulation: Water column: Weight:
Features:
 • HELLY TECH® Professional fabric
 • 20,000gm WP & 15,000gm moisture vapor permeability
 • Waterproof, Windproof and breathable
 • DWR C6 + hydrophilic lamination
 • Hard-shell fit provides maximum protection from the elements over long journeys, whilst allowing different layering options underneath
 • Helmet and backpack compatible design

Fabric:
 100% Polyamide

Colours:
 300 Patrol Orange
 639 Electric Blue
 990 Black



300

639

990

62939 ODIN LIGHT 3D SHELL JACKET

USD \$350



Sizes: S-2XL
Fitting: Regular
CB/Inseam: 81,5cm

Insulation: Water column: Weight:
Features:
 • HELLY TECH® Professional fabric
 • 2,75L fabric construction with 3D backing
 • Extreme ventilation
 • Packable
 • Light weight construction
 • Helmet and backpack compatible design

Fabric:
 Face: 100% Polyamide / Back: 100% Polyester

Colours:
 300 Patrol Orange
 990 Black



300

990



62833 ODIN STRETCH HOODED INSULATOR JACKET USD \$260

Sizes: S-2XL
Fitting: Regular
CB/Inseam: 75cm

Insulation: **Water column:** **Weight:**

Fabric:
 90% Polyamide,
 10% Elastane

Colours:
 300 Patrol Orange
 597 Navy
 991 Black

Features:

- Lightweight 30D fabric
- 4-way stretch fabric
- Stretch lining
- Durable Water Repellency (DWR) treatment
- Primaloft® Gold Active + 80gstretch Insulation
- Full inner front placket
- YKK® zippers
- Seamless underarm stretch panels
- Hood with sculpted brim
- Soft edge band around hood and cuffs
- Hi vis details



597



300



991

62914 ODIN STRETCH HOODED LIGHT INSULATOR JACKET USD \$230

Sizes: S-2XL
Fitting: Regular
CB/Inseam: 75cm

Insulation: **Water column:** **Weight:**

Primaloft® Active
 Gold+ Insulation
 40g

Fabric:
 90% Polyamide,
 10% Elastane

Colours:
 639 Electric Blue
 793 Redwood
 991 Black

Features:

- Lightweight 30D fabric
- 4-way stretch fabric
- Durable Water Repellency (DWR) treatment
- Primaloft® Gold Active + 40gstretch Insulation
- Full inner front placket
- YKK® zippers
- Seamless underarm stretch panels
- Hood with sculpted brim
- Soft edge band around hood and cuffs
- Hi vis details



639



793



991

62940 ODIN STRETCH LIGHT INSULATOR VEST USD \$180

Sizes: S-2XL
Fitting: Regular
CB/Inseam: 75cm

Insulation: **Water column:** **Weight:**

Fabric:
 Face: 100% Polyamide / Back: 100% Polyurethane

Colours:
 300 Patrol Orange
 597 Navy
 991 Black

Features:

- Lightweight 30D fabric
- 4-way stretch fabric
- Durable Water Repellency (DWR) treatment
- Primaloft® Gold Active + 40gstretch Insulation
- YKK® zippers
- Seamless underarm stretch panels



300



597



991

62715 ODIN HUGINN PANT USD \$200

Sizes: S-3XL
Fitting: Regular
CB/Inseam: 86cm

Insulation: **Water column:** **Weight:**

Fabric:
 Face: 100% Polyester / Back: 100% Polyurethane

Colours:
 793 Redwood
 983 Slate
 990 Black

Features:

- Durable stretch, soft and flexible softshell fabric
- Water repellent, Windproof and breathable
- Durable Water Repellency (DWR) treatment
- Softshell dynamic fit allowing comfortable movement during variable conditions
- Well rounded, active fit provides comfort and protection for most daytime conditions
- Articulated knees for optimal mobility
- Gusset in crotch for freedom of movement
- Super soft brushed tricot at inner waist



983



793



990



62831 VERGLAS 3L SHELL JACKET

USD \$325

Sizes: S-2XL
Fitting: Regular
CB/Inseam: 80,5 cm

Insulation: **Water column:** 20000mm
Weight:

Fabric:
 89% Polyester,
 11% Elastane

Colours:
 300 Patrol Orange
 488 Scarab Green
 639 Electric Blue

Features:

- HELLY TECH® Professional fabric
- 3-layer fabric construction
- 100% Polyamide 70D x 70D face & 100% polyurethane back
- 20,000gm WP & 15,000gm moisture vapor permeability
- Waterproof, Windproof and breathable
- DWR C6 + hydrophilic lamination
- Hard-shell fit provides maximum protection from the elements while allowing different layering options underneath
- Helmet compatible hood with custom fit cord adjustment



MOUNTAIN ESSENTIALS

The essential collection for the classic mountain lover. Technical materials are thoughtfully combined with versatile design, creating great quality mountain pieces that can be enjoyed for years of adventure.

62999 VERGLAS 3L SHELL PANT

USD \$275

Sizes: S-2XL
Fitting: Regular
CB/Inseam: 85cm

Insulation: **Water column:** 33000/21000
Weight:

Fabric:
 100% Polyamide

Colours:
 611 Blue Mountain
 983 Slate

Features:

- HELLY TECH® Professional fabric
- 3-layer shell fabric
- 100% polyamide 70D X 70D face fabric
- Waterproof, Windproof, breathable & fully seam sealed
- C6 DWR
- Flexible hem boot lock construction with hook and ladder system
- YKK® zippers
- 7/8 side zip
- 2-way zipper for ventilation
- Secure water resistant zip thigh pocket
- Boot hooks at front leg hem
- Adjustable waist

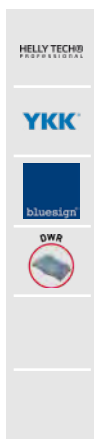

63000 VERGLAS TUR PANT

USD \$250

Sizes: S-2XL
Fitting: Regular
CB/Inseam: 82,5cm

Insulation: **Water column:**
Weight:

Fabric:
 94% Polyamide,
 6% Elastane

Colours:
 421 Lav Green
 983 Slate

Features:

- Durable poly/cotton mix main fabric with mechanical stretch
- PFC DWR
- Durable 4-way stretch softshell panels at knees, seat and crotch gusset
- Oekotex certified fabric
- Flexible hem boot lock construction with hook and ladder system
- 7/8 side zip with 2-way zip for ventilation
- 4 zipped secure pockets
- Boot hooks at front leg hem
- Reinforced insteps at hem
- Integrated Adjustable waist with fastener
- YKK® zippers



63001 VEIR TUR PANT

USD \$200

Sizes: S-2XL
Fitting: Regular
CB/Inseam: 82,5cm

Insulation: **Water column:**
Weight:

Fabric:
 Shell: 67% Polyester, 33% Cotton - Shell 2:
 94% Polyamide,
 6% Elastane

Colours:
 421 Lav Green
 983 Slate

Features:

- Durable poly/cotton mix main fabric with mechanical stretch
- PFC DWR
- Durable 4-way stretch softshell panels at seat, knees
- Gusset at crotch
- Oekotex certified fabric
- Flexible hem boot lock construction with hook and ladder system
- Side zip for ventilation
- Two front pockets with flap
- One secure zipped
- Boot hooks at front leg hem
- Reinforced insteps at hem



62943 TINDEN LIGHT PANT

USD \$120

Sizes: S-2XL
Fitting: Regular
CB/Inseam: 82cm

Insulation:
Water column:
Weight:

Fabric: 100% Polyamide

Colours: 421 Lav Green
980 Ebony

Features:

- Lightweight 4-way stretch woven nylon ripstop
- Integrated webbing belt with HH® buckle
- Two front hand pockets
- One welt back pocket
- Gusset in crotch for freedom of movement
- Articulated pattern
- Adjustable bottom hem with drawcord
- YKK® front fly zipper
- YKK® right side seam pocket



62788 VANIR BRONO PANT

USD \$100



Sizes: S-2XL
Fitting: Regular
CB/Inseam: 81cm

Insulation:
Water column:
Weight:

Fabric:

Colours: 597 Navy
980 Ebony

Features:

- Durable stretch, soft and flexible softshell fabric
- Water repellant, Windproof and breathable
- Durable Water Repellency (DWR) treatment
- Softshell dynamic fit allowing comfortable movement during variable conditions
- Inseam length: 88cm
- Articulated knees for optimal mobility
- Gusset in crotch for freedom of movement
- Front fly YKK® zipper of low profile reversed coil



63002 VERGLAS ICEFALL DOWN JACKET

USD \$350

Sizes: S-2XL
Fitting: Regular
CB/Inseam: 76,5cm

Insulation:
Water column:
Weight:

Fabric: 100% Polyamide

Colours: 611 Blue Mountain
983 Slate
990 Black

Features:

- 20D Nano ripstop down proof fabric
- Allied® Down 85/15 European goose
- Primaloft® Silver water resistant insulation 133g in hood, shoulder panels, sides and sleeve ends
- PFC free DWR
- Packable into stuff sack
- Adjustable hood
- Full inner centric front storm flap for wind block
- Two front hand pockets
- One inside chest pocket
- YKK® zippers
- Velcro adjustable sleeve ends



63005 VERGLAS HOODED DOWN INSULATOR JACKET USD \$300

Sizes: S-2XL
Fitting: Regular
CB/Inseam: 73,5cm

Insulation:
Water column:
Weight:

Fabric: 100% Polyamide

Colours: 300 Patrol Orange
380 Antique Moss
597 Navy
639 Electric Blue
990 Black

Features:

- 20D Nano ripstop down fabric
- Allied® Down 85/15 European goose
- Fill power 700+
- C6 DWR
- YKK® zippers
- Two front hand pockets
- 1 inner chest pocket
- Full inner front placket for wind block
- Snug down filled hood
- Clean finish elastic sleeve ends
- Adjustable bottom hem
- Inner neck hanger loop



63006 VERGLAS DOWN INSULATOR JACKET

USD \$275

Sizes: S-2XL
Fitting: Regular
CB/Inseam: 73,5cm

Insulation: **Water column:** **Weight:**

Fabric:
100% Polyamide

Colours:
222 Alert Red
380 Antique Moss
597 Navy
639 Electric Blue
990 Black

Features:

- 20D Nano ripstop down fabric
- Allied® Down 85/15 European goose
- Fill power 700+
- C6 DWR
- YKK® zippers
- Two front hand pockets
- 1 inner chest pocket
- Full inner front placket for wind block
- Clean finish elastic sleeve ends
- Adjustable bottom hem
- Inner neck hanger loop



222



380

597

639

990

63007 VERGLAS HOODED DOWN HYBRID INSULATOR JACKET

USD \$280

Sizes: S-2XL
Fitting: Regular
CB/Inseam: 73,5cm

Insulation: **Water column:** **Weight:**

Fabric:
100% Polyamide

Colours:
300 Patrol Orange
639 Electric Blue
983 Slate
990 Black

Features:

- Hybrid construction
- 20D Nano ripstop down fabric paired with breathable softshell panels at underarm, sides, back shoulder and lower cuffs
- Allied® Down 85/15 European goose in body
- Fill power 700+
- Primaloft® Silver insulation 60g in hood and shoulder panels
- C6 DWR
- YKK® zippers
- Two front hand pockets
- 1 inner chest pocket
- Full inner front placket for wind block

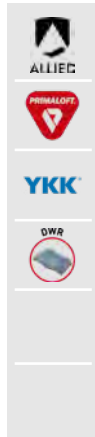

300



639

983

990

63008 VERGLAS DOWN INSULATOR VEST

USD \$250

Sizes: S-2XL
Fitting: Regular
CB/Inseam: 73,5cm

Insulation: **Water column:** **Weight:**

Fabric:
100% Polyamide

Colours:
300 Patrol Orange
597 Navy
990 Black

Features:

- 20D Nano ripstop down fabric
- Allied® Down 85/15 European goose
- Fill power 700+
- C6 DWR
- YKK® zippers
- Two front hand pockets
- 1 inner chest pocket
- Full inner front placket for wind block
- Adjustable bottom hem
- Inner neck hanger loop



300



597

990

62946 VERGLAS LIGHT HOODIE

USD \$75

Sizes: S-2XL
Fitting: Regular
CB/Inseam: 72,5cm

Insulation: **Water column:** **Weight:**

Fabric:
86% Polyamide,
14% Elastane

Colours:
421 Lav Green
597 Navy
971 Quiet Shade

Features:

- Super soft 205g fabric with elastane
- Wicking properties
- Flat drawcord adjustment in hood



597



421

971

62947 VERGLAS 1/2 ZIP

USD \$75

Sizes: S-2XL
Fitting: Regular
CB/Inseam: 72,5cm

Insulation:
Water column:
Weight:

Features:

- Super soft 205gfabric with elastane
- Wicking properties
- YKK® front zipper

Fabric:
 49% Polyamide,
 45% Polyester, 6%
 Elastane

Colours:
 421 Lav Green
 597 Navy
 971 Quiet Shade



597



421

971

62949 VERGLAS GO T-SHIRT

USD \$40

Sizes: S-2XL
Fitting: Regular
CB/Inseam: 72cm

Insulation:
Water column:
Weight:

Features:

- Polyester/elastane knit t-shirt
- Wicking properties

Fabric:
 49% Polyamide,
 45% Polyester, 6%
 Elastane

Colours:
 421 Lav Green
 597 Navy
 980 Ebony



597



421

980

62987 PARAMOUNT HOODED SOFTSHELL JACKET USD \$160

Sizes: S-2XL
Fitting: Regular
CB/Inseam: 75cm

Insulation:
Water column:
Weight:

Features:

- Water resistant, windproof and breathable
- Comfortable and light softshell fabric with a membrane
- Hood with cord adjustments
- Fleece backing
- YKK® full front zip
- Adjustable cuffs
- YKK® zipped hand pockets
- YKK® zipped chest pocket
- Chin guard

Fabric:
 60% Cotton, 40%
 Polyester

Colours:
 421 Lav Green
 597 Navy
 990 Black



421



597

990

62915 PARAMOUNT SOFTSHELL JACKET

USD \$130

Sizes: S-2XL
Fitting: Regular
CB/Inseam:

Insulation:
Water column:
Weight:

Features:

- Water resistant, windproof and breathable
- Comfortable and light softshell fabric with a membrane
- Fleece backing
- YKK® full front zip
- Adjustable cuffs
- YKK® zipped hand pockets
- YKK® zipped chest pocket
- Chin guard

Fabric:
 90% Polyamide,
 10% Elastane

Colours:
 421 Lav Green
 597 Navy
 990 Black



421



597

990



62916 PARAMOUNT SOFTSHELL VEST

USD \$110

Sizes: S-2XL
Fitting: Regular
CB/Inseam:

Insulation:
Water column:
Weight:

Fabric:
 Face: 90% Polyester, 10% Elastane / Back: 100% Polyurethane
Colours:
 597 Navy
 990 Black

- Features:**
- Water resistant, windproof and breathable
 - Comfortable and light softshell fabric with a membrane
 - Fleece backing
 - YKK® full front zip
 - YKK® zipped hand pockets
 - YKK® zipped chest pocket
 - Chin guard



990

62252 LOKE JACKET

USD \$100

Sizes: S-5XL
Fitting: Regular
CB/Inseam: 76cm

Insulation:
Water column: 10000mm
Weight:

Fabric:
 Face: 100% Polyester / Back: 100% Polyurethane
Colours:
 223 Alert Red
 482 Beluga
 483 Beluga Nmm Map
 639 Electric Blue
 983 Slate
 990 Black

- Features:**
- Waterproof, Windproof and breathable HELLY TECH® Performance, with 2.5 layer 100% polyester fabric with 100% polyurethane laminate
 - 10,000mm Waterproofness and 10,000gm moisture vapor permeability
 - Waterproof, Windproof, breathable & fully seam sealed



223



990



482



483



639



983



62265 LOKE PANTS

USD \$85

Sizes: XS-5XL
Fitting: Regular
CB/Inseam: 80cm

Insulation:
Water column: 10000mm
Weight:

Fabric:
 Face: 100% Polyamide / Back: 100% Polyurethane
Colours:
 990 Black

- Features:**
- Waterproof, Windproof and breathable HELLY TECH® Performance, with 2.5 layer 100% polyester fabric with 100% polyurethane laminate
 - 10,000mm Waterproofness and 10,000gm moisture vapor permeability
 - Waterproof, Windproof, breathable
 - Fully seam sealed
 - Durable Water Repellency (DWR) treatment



990



62952 ESSENTIAL CANVAS PANT

USD \$85

Sizes: S-2XL
Fitting: Relaxed
CB/Inseam: 84cm

Insulation:
Water column:
Weight:

Fabric:
 91% Polyester, 9% Elastane

- Features:**
- Five pocket canvas pant design
 - YKK® zippers

Colours:
 719 Cedar Brown
 720 Fallen Rock
 980 Ebony



719



720



980

63010 HOVIN INSULATED JACKET

USD \$250

Sizes: S-2XL
Fitting: Regular
CB/Inseam: 84,5cm

Insulation:
Water column: 7800
Weight:

Fabric:
 Shell: 100% Polyester - Shell:
 100% Polyester
 - Lining: 100% Polyamide -
 Insulation body:
 100% Recycled Polyester -
 Insulation sleeves:
 100% Recycled Polyester

Colours:
 482 Beluga
 581 Marine Blue
 980 Ebony

Features:

- 2-layer HELLY TECH® Protection main fabric
- PFC free DWR
- Fully taped
- Primaloft® Black ECO 100% recycled insulation, 60g in body and 40g in hood/sleeves
- 2 zipped hand pockets and 2 flap pockets at front
- One inside zipped chest pocket
- YKK® zippers
- Adjustable hood
- Front placket with snap closure
- Adjustable cuffs



482



581



980

FJORD TIL FJELL

The Fjord til Fjell collection captures the essence of the Helly Hansen identity and the Norwegian outdoor lifestyle – the adventures from the fjord to the mountains! Inspired by the spectacular Norwegian nature, we have developed a collection of multi-purpose, lightweight technical gear that caters for all your adventure and travel requirements. Great looking, practical and functional – this line will work whether you set out for an adventure by the fjords, hike up to the top of the mountain or enjoy a cup of coffee in the city.



63009 GREFSEN 2L SHELL JACKET

USD \$150

Sizes: S-2XL
Fitting: Regular
CB/Inseam: 77cm

Insulation:
Water column: 12500/4800
Weight:

Fabric:
 100% Polyester

Colours:
 482 Beluga
 597 Navy
 990 Black

Features:

- HELLY TECH® Protection
- Waterproof, windproof and breathable
- 2-layer construction
- Fully seam sealed
- PFC Free DWR
- Lined for comfort
- Quick dry lining
- Fixed hood
- One hand hood adjustments
- Front storm flap
- YKK® front zipper
- YKK® zipped hand pockets
- Adjustable cuffs
- Adjustable bottom hem



597



482



990

63011 MEYER INSULATED JACKET

USD \$200

Sizes: S-2XL
Fitting: Regular
CB/Inseam: 74cm

Insulation:
Water column: >11000
Weight:

Fabric:
 100% Polyester

Colours:
 482 Beluga
 719 Cedar Brown
 720 Fallen Rock

Features:

- Polyester fabric treated with cire for water resistance
- PFC Free DWR
- Bluesign® approved fabric
- Corduroy collar
- Primaloft Black ECO, 80g insulation in body 60g in sleeves
- Center front zipper
- 4 front pockets
- YKK® zippers
- Inside chest pocket
- Sleeve cuff adjustment with snaps



482



719



720

63012 MEYER INSULATED VEST

USD \$150

Sizes: S-2XL
Fitting: Regular
CB/Inseam: 74cm

Insulation:
Water column:
Weight:

Fabric:
 Shell: 100% Polyester - Lining:
 100% Polyamide -
 Insulation body:
 100% Recycled Polyester

Colours:
 482 Beluga
 980 Ebony

Features:

- Polyester fabric treated with cire for water resistance
- PFC Free DWR
- Bluesign® approved fabric
- Corduroy collar
- Primaloft Black ECO 80g insulation
- Center front zipper
- 4 front pockets
- YKK® zippers
- Inside chest pocket



482



980

63013 KOLSAAS FLEECE JACKET

USD \$130

Sizes: S-2XL
Fitting: Regular
CB/Inseam: 74,5cm

Water column:
Weight:

Fabric:
 100% Recycled Polyester

Colours:
 706 Aluminum
 778 Kodiak Brown
 980 Ebony

Features:

- Double velour micro fleece fabric
- 100% recycled polyester
- Bluesign® approved fabric
- YKK® zippers
- Full front zipper with storm flap
- 2 zipped front hand pockets
- Contrast shoulder and collar panels
- Contrast chest pocket



706



778

980



63014 KULPEN PRINTED FLEECE

USD \$80

Sizes: S-2XL
Fitting: Regular
CB/Inseam: 72,5cm

Insulation:
Water column:
Weight:

Fabric:
 100% Polyester

Colours:
 034 Cream Norwegian Knit Print
 482 Beluga Norwegian Knit Print
 983 Slate Norwegian Knit Print

Features:

- Allover printed micro fleece fabric
- Bluesign® approved
- YKK® half zip collar
- 2 front welt hand pockets
- 1 chest welt pocket



034



482

983



62918 WOOL KNIT SWEATER

USD \$175

Sizes: S-2XL
Fitting: Regular
70cm

Insulation:
Water column:
Weight:

Fabric:
 65% Merino Wool, 35% Nylon

Colours:
 598 Navy
 930 Light Grey
 990 Black

Features:

- Soft merino wool blend kitted sweater
- 65% Merino Wool 35% Nylon
- Fun and playful colors and graphics
- Raglan sleeves
- 1x1 rib at bottom hem and collar



598



930

990



63042 ODDEN STRIPE KNIT SWEATER

USD \$110

Sizes: S-2XL
Fitting: Regular
CB/Inseam: 70cm

Insulation:
Water column:
Weight:

Fabric:
 60% Organic Cotton, 40% Recycled Polyester

Colours:
 482 Beluga
 930 Light Grey

Features:

- 60% organic cotton / 40% recycled polyester soft knit fabric
- Set in sleeve construction
- 1x1 rib at bottom hem and collar



482



930



63015 LILLO SWEATER

USD \$120

Sizes: S-2XL
 Fitting: Regular
 CB/Inseam: 71cm
 Insulation: Water column: Weight:

Fabric:
 Shell: 98% Polyester, 2% Elastane - Shell 2: 100% Polyester
Colours:
 034 Cream
 488 Scarab Green
 980 Ebony

Features:
 • Quilted polyester jersey fabric
 • Contrast panels on collar and shoulders
 • PFC Free DWR
 • 100% Bluesign® approved fabric
 • Pullover with snap closure
 • Chest pocket
 • Adjustable bottom hem



034



488



980

62897 HOLMEN 5 POCKET PANT

USD \$100

Sizes: S-2XL
 Fitting: Regular
 CB/Inseam: 83cm
 Insulation: Water column: Weight:

Fabric:
 96% Polyester, 4% Elastane
Colours:
 719 Cedar Brown
 721 Fallen Rock
 983 Slate

Features:
 • Warp stretch twill weave fabric
 • 100% fabric
 • Gusset at crotch for freedom of movement
 • Front hand pockets
 • Back patch pockets
 • Secure YKK® zip pocket at thigh



719



721



983

62898 SKAR PANT

USD \$110

Sizes: S-2XL
 Fitting: Regular
 CB/Inseam:
 Insulation: Water column: Weight:

Fabric:
 94% Polyamide, 6% Elastane
Colours:
 421 Lav Green
 719 Cedar Brown
 983 Slate

Features:
 • Warp stretch twill weave fabric
 • 100% fabric
 • Articulated knees for optimal mobility
 • Gusset in crotch for freedom of movement pattern incorporates additional freedom of movement into the leg
 • Front slant pockets
 • Back patch pockets
 • Pocket storage at thighs
 • Belt loops



421



719



983

62919 WOOL TRAVEL PANT

USD \$170

Sizes: S-2XL
 Fitting: Regular
 CB/Inseam: 79cm
 Insulation: Water column: Weight:

Fabric:
 60% Recycled wool, 36.5% Viscose, 2.5% Polyamide, 1% Elastane
Colours:
 482 Beluga
 981 Ebony

Features:
 • Stretchy, soft and comfortable wool mix fabric
 • 60% Recycled wool, 36.5% Viscose, 2.5% Polyamide, 1% Elastane
 • Super soft and comfortable recycled wool
 • Elastic waist and bottom hem with flat front
 • YKK® front zipped fly and button closure
 • Hand pockets, thigh pockets and back zipped pocket
 • Articulated pattern construction



482



981



62920 LIFALOFT™ INSULATED FLANNEL SHIRT USD \$190

Sizes:
S-2XL

Fitting:
Relaxed

CB/Inseam:
76,5cm

Insulation:
LIFALOFT™
Insulation 80g

Water column:

Weight:

Fabric:
65% Polyester, 35% Cotton

Colours:
222 Alert Red
853 Grey Fog Plaid
980 Ebony
990 Black Plaid

Features:

- Insulated flannel long sleeve button-up shirt
- 173g cotton/polyester fabric
- LIFALOFT™ insulation by Primaloft®@80g insulation in body and sleeves
- Soft and cozy lining
- Flap front chest pocket
- Lower welt hand pockets



222



853

980

990



63016 RYES SNAP FLEECE SHIRT JACKET USD \$140

Sizes:
S-2XL

Fitting:
Relaxed

CB/Inseam:
75cm

Insulation:

Weight:

Fabric:
100% Recycled Polyester

Colours:
581 Marine Blue Melange
971 Quiet Shade Melange
980 Ebony Melange

Features:

- Double velour micro fleece fabric
- 100% recycled polyester
- Bluesign® approved fabric
- Button up design
- Contrast chest pocket and cuff detail
- CB hanger loop



581



971

980



62937 WOOL LS SHIRT USD \$140

Sizes:
S-2XL

Fitting:
Regular

CB/Inseam:
77cm

Insulation:

Water column:

Weight:

Fabric:
70% Wool, 30% Polyamide

Colours:
034 Cream
482 Beluga
598 Navy Plaid

Features:

- Nice and warm wool button up shirt
- 226g fabrics with 70% wool
- Dual front chest pockets with closure
- Buttoned cuffs
- Hanger loop



482



034

598



62921 OSLO LS SHIRT USD \$75

Sizes:
S-2XL

Fitting:
Regular

CB/Inseam:
77,5cm

Insulation:

Water column:

Weight:

Fabric:
46% Cotton, 24% Polyester, 16% Acrylic, 13% Viscose, 1% Elastane,

Colours:
488 Scarab Green
598 Navy Slub
971 Quiet Shade
980 Ebony

Features:

- Classic style long sleeve button up shirt
- Mélange flannel, multi-colored slub and printed colorways
- Front chest pocket



488



598

971

980



62923 CLASSIC CHECK LS SHIRT

USD \$75

Sizes: S-2XL **Regular** **CB/Inseam:** 77cm
Insulation: **Water column:** **Weight:**

Features:
 • The classic checked flannel shirt!
 • 185g 100% cotton flannel fabric
 • Front chest pocket
 • Buttoned front and cuffs

Fabric:
 100% Cotton

Colours:
 458 Uniform Green
 482 Beluga Plaid
 581 Marine Blue
 990 Black



458



482

581

990



62934 F2F COTTON HOODIE

USD \$60

Sizes: S-2XL **Fitting:** Regular **CB/Inseam:** 71cm
Insulation: **Water column:** **Weight:**

Features:
 • Polyester/ cotton mix jersey hoodie
 • Fun and playful graphics
 • Front kangaroo pocket
 • Front Adjustable hood
 • 1x1 rib at cuffs and hem

Fabric:
 80% Cotton, 20% Polyester

Colours:
 581 Marine Blue
 599 Navy
 842 Penguin Melange
 982 Ebony Melange



599



581

842

982



62933 F2F COTTON SWEATER

USD \$50

Sizes: S-2XL **Fitting:** Regular **CB/Inseam:** 71cm
Insulation: **Water column:** **Weight:**

Features:
 • Polyester / crew neck sweater
 • Fun and playful graphics
 • 1x1 rib at cuffs, neck and bottom hem

Fabric:
 80% Cotton, 20% Polyester

Colours:
 581 Marine Blue
 599 Navy
 842 Penguin Melange
 982 Ebony Melange



581



599

842

982



63017 HYGGEN LIGHT HOODIE

USD \$80

Sizes: S-2XL **Fitting:** Regular **CB/Inseam:** 71cm
Insulation: **Water column:** **Weight:**

Features:
 • Lightweight double face knit
 • Soft and comfortable
 • 100% Bluesign approved fabric
 • Adjustable hood with drawcord
 • Left chest pocket

Fabric:
 100% Polyester

Colours:
 482 Beluga
 581 Marine Blue
 597 Navy
 971 Quiet Shade



482



581

597

971



63019 HYGGEN LS HENLEY

USD \$60

Sizes: S-2XL
Fitting: Regular
CB/Inseam: 70,5cm

Insulation:
Water column:
Weight:

Fabric:
 Shell: 100% Polyester

- Features:**
- Lightweight double face knit
 - Soft and comfortable Henley button design
 - 100% Bluesign® approved fabric

034 Cream
 482 Beluga
 581 Marine Blue
 597 Navy
 971 Quiet Shade



971



034

482

581

597



62856 SKOG GRAPHIC T-SHIRT

USD \$40

Sizes: S-2XL
Fitting: Regular
CB/Inseam: 72cm

Insulation:
Water column:
Weight:

Fabric:
 Face: 100% Polyamide / Back: 100% Polyester

- Features:**
- Recycled polyester fabric
 - Versatile tee for all conditions
 - 100% fabric
 - UPF 30
 - Various custom graphic print designs

Colours:
 421 Lav Green
 611 Blue Mountain
 842 Penguin
 982 Ebony



982



421

611

842



67415 ROAM TRAPPER HAT

USD \$60

Sizes: STD
Fitting: Regular
CB/Inseam:

Insulation:
Water column:
Weight:

Fabric:
 50% Wool, 50% Polyester

- Features:**
- Extra cozy
 - Pile Lining
 - Ear covers
 - Button-up chin strap

Colours:
 215 Oxblood
 990 Black



215



990

67418 ROAM GLOVES

USD \$45

Sizes: S-XL
Fitting: Regular
CB/Inseam:

Insulation:
Water column:
Weight:

Fabric:
 85% Wool, 15% Acrylic

- Features:**
- Wool Gloves
 - Reinforced palm
 - Convertible mitten flap cover

Colours:
 597 Navy
 857 Pelican



597



857

62975 NORD GRAPHIC PULL OVER HOODIE

USD \$60

Sizes: S-2XL Fitting: Regular CB/Inseam:

Insulation: Water column:

Fabric: 80% Cotton, 20% Polyester

- Features:
- Cotton polyester mix fabric
 - Helly Hansen® Nord graphic across chest
 - Kangaroo pocket
 - Adjustable hood with drawstring

- Colours:
- 300 Patrol Orange
 - 421 Lav Green Melange
 - 581 Marine Blue Melange
 - 597 Navy
 - 949 Grey Melange
 - 980 Ebony



949



980



300



421



581



597

62976 NORD GRAPHIC CREW SWEATSHIRT

USD \$50

Sizes: S-2XL Fitting: Regular CB/Inseam:

Insulation: Water column: Weight:

Fabric: 80% Cotton, 20% Polyester

- Cotton polyester mix fabric
- Helly Hansen® Nord graphic across chest
 - Crew neck style

- Colours:
- 421 Lav Green Melange
 - 597 Navy
 - 949 Grey Melange
 - 980 Ebony



421



597



949



980

62977 NORD GRAPHIC LONGSLEEVE T-SHIRT

USD \$40

Sizes: S-2XL Fitting: Regular CB/Inseam:

Insulation: Water column: Weight:

Fabric: 80% Cotton, 20% Polyester

- Features:
- Cotton polyester mix t-shirt fabric
 - Helly Hansen® Nord graphic logo on across chest

- Colours:
- 421 Lav Green Melange
 - 581 Marine Blue Melange
 - 597 Navy
 - 949 Grey Melange
 - 980 Ebony



421



581



597



949



980

62978 NORD GRAPHIC T-SHIRT

USD \$30

Sizes: S-2XL Fitting: Regular CB/Inseam:

Insulation: Water column: Weight:

Fabric: 60% Cotton, 40% Polyester

- Features:
- Cotton polyester mix t-shirt fabric
 - Helly Hansen® Nord graphic logo on across chest

- Colours:
- 001 White
 - 300 Patrol Orange
 - 488 Scarab Green
 - 581 Marine Blue
 - Melange
 - 949 Grey Melange
 - 980 Ebony



001



980



300



488



581



949



MEN'S BASE LAYER

49359 LIFA MERINO HEAVYWEIGHT 1/2 ZIP

USD \$140

Sizes: S-2XL
 Fitting: Regular
 CB/Inseam: 72cm
 Insulation: Water column: Weight: 250G/M2
 Fabric: 65% Merino Wool, 35% Polypropylene
 Colours: 597 Navy, 793 Redwood, 990 Black

- Features:**
- 2-layer construction
 - 250g LIFA® Merino fabric
 - Brushed interior
 - 1/2 zip construction
 - Non-itch
 - Flat lock seams



597



793

990

49360 LIFA MERINO HEAVYWEIGHT CREW

USD \$130

Sizes: S-2XL
 Fitting: Regular
 CB/Inseam: 72cm
 Insulation: Water column: Weight: 250G/M2
 Fabric: 65% Merino Wool, 35% Polypropylene
 Colours: 421 Lav Green, 597 Navy, 793 Redwood, 990 Black

- Features:**
- 2-layer construction
 - 250g LIFA® Merino fabric
 - Brushed interior
 - Non-itch
 - Flat lock seams



421



597

793

990

49361 LIFA MERINO HEAVYWEIGHT PANT

USD \$110

Sizes: S-2XL
 Fitting: Regular
 CB/Inseam: 80cm
 Insulation: Water column: Weight: 250G/M2
 Fabric: 65% Merino Wool, 35% Polypropylene
 Colours: 597 Navy, 990 Black

- Features:**
- 2-layer construction
 - 250g LIFA® Merino fabric
 - Brushed interior
 - Non-itch
 - Flat lock seams



597



990

49363 LIFA MERINO MIDWEIGHT 1/2 ZIP

USD \$110

Sizes: S-2XL
 Fitting: Regular
 CB/Inseam: 72cm
 Insulation: Water column: Weight: 225G/M2
 Fabric: 57% Merino Wool, 43% Polypropylene
 Colours: 421 Lav Green, 597 Navy, 639 Electric Blue, 990 Black

- Features:**
- 2-layer construction
 - 1/2 zip construction
 - 100% Merino Wool exterior
 - 225g LIFA® Merino fabric
 - Non-itch
 - Flat lock seams



639



421

597

990

MEN'S BASE LAYER

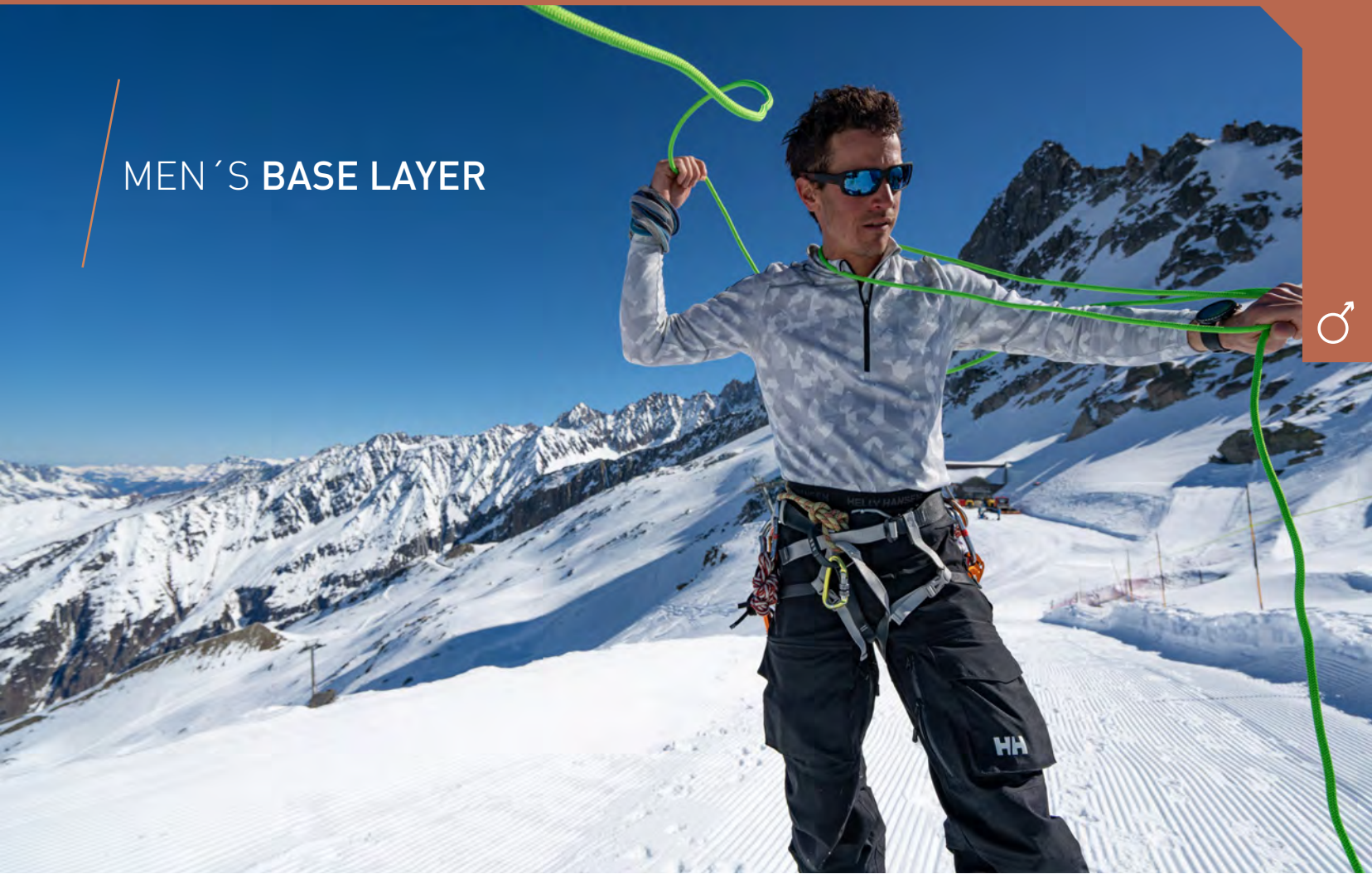

49362 LIFA MERINO MIDWEIGHT HOODIE USD \$120

Sizes: S-2XL
Fitting: Regular
CB/Inseam: 72cm

Insulation: Water column: 225G/M2

Fabric: 57% Merino Wool, 43% Polypropylene

Colours: 421 Lav Green, 597 Navy, 990 Black

- Features:
- 2-layer construction
 - Hood for added warmth
 - 100% Merino Wool exterior
 - 225g LIFA® Merino fabric
 - Non-itch
 - Flat lock seams



990



421

597

LIFA MERINO MIDWEIGHT is perfect for any type of activity in cold weather. A unique 2-in-1 base layer with 100% merino wool combined with LIFA® Stay Warm Technology in a 2 layer construction. LIFA® Merino MIDWEIGHT delivers all the great benefits of merino wool fibers plus the unique properties of technical LIFA® fibers.

MEN'S BASE LAYER

49364 LIFA MERINO MIDWEIGHT CREW

USD \$100

Sizes: S-2XL
Fitting: Regular
CB/Inseam: 72cm
Insulation:
Water column:
Weight: 225G/M2

Fabric: 57% Merino Wool, 43% Polypropylene
Features:
 • 2-layer construction
 • 100% Merino Wool exterior
 • 225g LIFA® Merino fabric
 • Non-itch
 • Flat lock seams

Colours:
 421 Lav Green
 597 Navy
 599 Navy
 603 North Sea Blue
 639 Electric Blue
 793 Redwood
 983 Slate
 990 Black



983



639

793

990



421

597

599

603

49366 LIFA MERINO MIDWEIGHT PANT

USD \$100

Sizes: S-2XL
Fitting: Regular
CB/Inseam: 80cm
Insulation:
Weight: 225G/M2

Features:
 • 2-layer construction
 • 100% Merino Wool exterior
 • 225g LIFA® Merino fabric
 • Non-itch
 • Flat lock seams

Colours:
 421 Lav Green
 597 Navy
 599 Navy
 990 Black



597



421

599

990

49367 LIFA MERINO MIDWEIGHT 3/4 PANT

USD \$80

Sizes: S-2XL
Fitting: Regular
CB/Inseam: 49cm
Insulation:
Water column:
Weight: 225G/M2

Fabric: 57% Merino Wool, 43% Polypropylene
Features:
 • 2-layer construction
 • 3/4 length
 • 100% Merino Wool exterior
 • 225g LIFA® Merino fabric
 • Non-itch
 • Flat lock seams

Colours:
 990 Black



990

49368 LIFA MERINO LIGHTWEIGHT HOODIE

USD \$110

Sizes: S-2XL
Fitting: Regular
CB/Inseam: 72cm
Insulation:
Water column:
Weight: 160G/M2

Fabric: 70% Merino Wool, 30% Polypropylene
Features:
 • 2-layer construction
 • Hood for added warmth
 • 1/2 zip construction
 • 100% Merino Wool exterior
 • 160g LIFA® Merino fabric
 • Non-itch
 • Flat lock seams

Colours:
 639 Electric Blue
 990 Black



639



990

49369 LIFA MERINO LIGHTWEIGHT 1/2 ZIP

USD \$100

Sizes: S-2XL
Fitting: Regular
CB/Inseam: 72cm
Insulation:
Water column:
Weight: 160G/M2

Fabric:
 70% Merino Wool,
 30% Polypropylene

Colours:
 421 Lav Green
 639 Electric Blue
 990 Black

Features:

- 2-layer construction
- 1/2 zip construction
- 100% Merino Wool exterior
- 160g LIFA® Merino fabric
- Non-itch
- Flat lock seams



421



639



990

49370 LIFA MERINO LIGHTWEIGHT CREW

USD \$90

Sizes: S-2XL
Fitting: Regular
CB/Inseam: 72cm
Insulation:
Water column:
Weight: 160G/M2

Fabric:
 70% Merino Wool,
 30% Polypropylene

Colours:
 421 Lav Green
 639 Electric Blue
 983 Slate
 990 Black

Features:

- 2-layer construction
- 100% Merino Wool exterior
- 160g LIFA® Merino fabric
- Non-itch
- Flat lock seams



983



421



639



990

49371 LIFA MERINO LIGHTWEIGHT PANT

USD \$90

Sizes: S-2XL
Fitting: Regular
CB/Inseam: 80cm
Insulation:
Water column:
Weight: 160G/M2

Fabric:
 70% Merino Wool,
 30% Polypropylene

Colours:
 983 Slate
 990 Black

Features:

- 2-layer construction
- 100% Merino Wool exterior
- 160g LIFA® Merino fabric
- Non-itch
- Flat lock seams



983



990

48356 HH MERINO MID 1/2 ZIP

USD \$110

Sizes: S-2XL
Fitting: Regular
CB/Inseam: 72cm
Insulation:
Water column:
Weight: 195G/M2

Fabric:
 100% Merino Wool

Colours:
 421 Lav Green
 966 Charcoal
 Melange
 991 Black

Features:

- 100% Merino wool
- 19,5 micron
- Non Mulesed
- Flat lock stitches
- 195g/m2 fabric



421



966



991



MEN'S BASE LAYER

48355 HH MERINO MID LS

USD \$100

Sizes: S-2XL
Fitting: Regular
CB/Inseam: 72cm

Insulation:
Water column:
Weight: 195G/M2

Features:

- 100% Merino wool
- 19,5 micron
- Non Mulesed
- Flat lock stitches
- 195g/m2 fabric

Fabric:
100% Merino Wool

Colours:
421 Lav Green
966 Charcoal
Melange
991 Black



966



421

991

49402 HH MERINO MID GRAPHIC CREW

USD \$130

Sizes: S-2XL
Fitting: Regular
CB/Inseam: 72cm

Insulation:
Water column:
Weight: 195G/M2

Features:

- 100% Merino wool
- 19,5 micron
- Non Mulesed
- Flat lock stitches
- 195g/m2 fabric

Fabric:
100% Merino Wool

Colours:
597 Navy
964 Charcoal
990 Black



597



964

990

48471 HH MERINO MID PANT

USD \$90

Sizes: S-2XL
Fitting: Regular
CB/Inseam: 79cm

Insulation:
Water column:
Weight: 195G/M2

Features:

- 100% Merino wool
- 19,5 micron
- Non Mulesed
- Flat lock stitches
- 195g/m2 fabric

Fabric:
100% Merino Wool

Colours:
965 Charcoal
Melange
990 Black



965



990

49388 LIFA ACTIVE 1/2 ZIP

USD \$65

Sizes: S-2XL
Fitting: Regular
CB/Inseam: 72cm

Insulation:
Water column:
Weight: 130G/M2

Features:

- 2-layer construction
- Excellent moisture management properties
- 1/2 zip construction
- LIFA® fibers interior
- Wicking polyester exterior
- Flat lock seams

Fabric:
65% Polyester, 35% Polypropylene

Colours:
639 Electric Blue
980 Ebony
990 Black



639



980

990

49389 LIFA ACTIVE CREW

USD \$55

Sizes: S-2XL
Fitting: Regular
CB/Inseam: 72cm

Insulation:
Water column:
Weight: 130G/M2

Fabric:
65% Polyester, 35% Polypropylene

Colours:
597 Navy
639 Electric Blue
980 Ebony
990 Black

Features:

- 2-layer construction
- Excellent moisture management properties
- LIFA® fibers interior
- Wicking polyester exterior
- Flat lock seams

lifa



597



639



980



990

49390 LIFA ACTIVE PANT

USD \$50

Sizes: S-2XL
Fitting: Regular
CB/Inseam: 80cm

Insulation:
Water column:
Weight: 130G/M2

Fabric:
65% Polyester, 35% Polypropylene

Colours:
639 Electric Blue
980 Ebony
990 Black

Features:

- 2-layer construction
- Excellent moisture management properties
- LIFA® fibers interior
- Wicking polyester exterior
- Flat lock seams

lifa



639



980



990

48800 HH LIFA STRIPE CREW

USD \$40

Sizes: S-2XL
Fitting: Regular
CB/Inseam: 74cm

Insulation:
Water column:
Weight: 125G/M2

Fabric:
100% Polypropylene

Colours:
001 White
421 Lav Green
597 Navy
998 Black

Features:

- Lightweight insulation
- 100% LIFA®
- Flatlock seams for max comfort
- Natural stretch fabric

lifa



597



421



001



998

48305 HH LIFA PANT

USD \$40

Sizes: S-2XL
Fitting: Regular
CB/Inseam: 75cm

Insulation:
Water column:
Weight:

Fabric:
100% Polypropylene

Colours:
597 Navy
990 Black

Features:

- Lightweight insulation
- 100% LIFA®
- Elastic waist band for great fit and freedom of movement
- Flatlock seams for max comfort

lifa



597



990



MEN'S BASE LAYER

48365 HH TECH 1/2 ZIP

USD \$40.00

Sizes:
XS|S|M|L|XL
2XL|3XL|4XL

Fitting: **CB/Inseam:**
74cm

Water column: **Weight:**
140g/m2

Fabric:
100% Polyester

- Features:**
- Technical Polyester main fabric
 - 140gm/m2 fabric
 - Quick dry and Wicking
 - Flatlock seams for great next to skin comfort
 - Regular fit

Colours:
001 White
597 Navy
980 Ebony
930 Light Grey

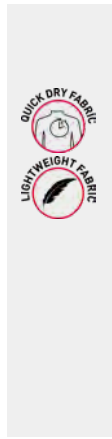

980



001



930

TECH

The HH Tech collection provides wearers with a quick drying and UPF rated garment. It is a lightweight fabric that is ideal to wear in hot conditions.

48364 HH TECH CREW

USD \$30.00

Sizes:
XS|S|M|L|XL
2XL|3XL|4XL

Fitting: **CB/Inseam:**
72cm

Water column: **Weight:**
140g/m2

Fabric:
100% Polyester

- Features:**
- Synthetic fabric
 - Quick dry and Wicking
 - Flatlock seams for next to skin comfort
 - 140gm/m2 fabric

Colours:
001 White
597 Navy
980 Ebony
930 Light grey

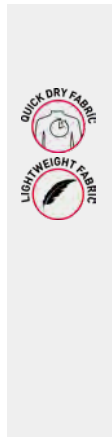

597



001



980



930

48363 HH TECH T-SHIRT

USD \$25.00

Sizes:
XS|S|M|L|XL
2XL|3XL|4XL

Fitting: **CB/Inseam:**
72cm

Water column: **Weight:**
140g/m2

Fabric:
46% Polyester,
39% Polyamide,
10% Tencel, 5%
Elastane

- Features:**
- Synthetic fabric
 - Quick dry and Wicking
 - Flatlock seams for next to skin comfort
 - 140gm/m2 fabric

Colours:
001 White
597 Navy
980 Ebony
930 Light grey

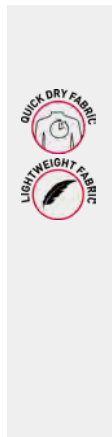

597



001



980



930



MEN'S MIDLAYER

51885 POWER AIR HEAT GRID JACKET

USD \$200

Sizes: S-2XL
 Fitting: Regular
 CB/Inseam: 71cm
 Insulation: Water column: 350G/M2

Fabric: 89% Recycled Polyester, 11% Elastane

Colours: 421 Lav Green
 639 Electric Blue
 990 Black

Features:

- Polartec® Power Air
- Efficient warmth
- Sheds at least 5x less microfibers
- Highly durable
- Resists Pilling
- Dual-surface construction



421



639

990

51886 POWER STRETCH PRO GLACIER HOODED JACKET

USD \$230

Sizes: S-2XL
 Fitting: Regular
 CB/Inseam: 73cm
 Insulation: Water column: 250G/M2
 Weight: 250G/M2

Fabric: 56% Polyester, 34% Polyamide, 10% Elastane

Colours: 639 Electric Blue
 793 Redwood
 990 Black

Features:

- Polartec® Power Stretch Pro
- 4-way stretch
- Superior abrasion resistance
- Highly breathable
- Wicks moisture
- Fast drying
- Shape retention



793



639

990

51887 POWER STRETCH PHANTOM 1/2 ZIP 3.0

USD \$130

Sizes: S-2XL
 Fitting: Regular
 CB/Inseam: 73cm
 Insulation: Weight: 225G/M2

Fabric: 84% Recycled Polyester, 16% Elastane

Colours: 226 Bright Orange
 639 Electric Blue
 990 Black

Features:

- Polartec® Power Stretch
- 4-way stretch
- Highly breathable
- Wicks moisture
- Fast drying
- Shape retention



639



226

990

51852 VANERN MIDLAYER

USD \$165

Sizes: S-2XL
 Fitting: Regular
 CB/Inseam: 75cm
 Insulation: Water column: 265G/M2
 Weight: 265G/M2

Fabric: Main Fabric: 80% Cotton, 20% Polyester / Back: 100% Polyurethane
 Contrast Fabric: 94% Polyamide, 6% Elastane

Colours: 421 Lav Green
 597 Navy

Windproof Fabric

- Water repellent fabric on shoulders and hood
- YKK® zipper



421



597



MEN'S MIDLAYER



51891 VARDE HOODED FLEECE JACKET

USD \$140

Sizes: S-2XL
Fitting: Regular
CB/Inseam: 75cm

Insulation:
Water column: 330G/M2

Fabric:
 100% Polyester

- Features:**
- Knitted fleece
 - Polyester woven fabric on hood for added protection
 - YKK® zipper

Colours:
 793 Redwood
 853 Grey Fog
 983 Slate



983



853



793

51850 VARDE FLEECE JACKET

USD \$125

Sizes: S-2XL
Fitting: Regular
CB/Inseam: 75cm

Water column: 330G/M2
Weight: 330G/M2

Fabric:
 100% Polyester

- Features:**
- Knitted fleece
 - Polyester woven fabric side panels
 - YKK® zipper

Colours:
 421 Lav Green
 598 Navy
 793 Redwood
 853 Grey Fog
 983 Slate



853



598



793



421



983

MEN'S MIDLAYER

51851 VARDE 1/2 ZIP FLEECE

USD \$110

Sizes: S-2XL
Fitting: Regular
CB/Inseam: 75cm
Insulation:
Water column:
Weight: 330G/M2
Fabric: 100% Polyester
Features:
 • Knitted fleece
 • Polyester woven fabric side panels
 • YKK® zipper

421 Lav Green
 597 Navy
 793 Redwood
 853 Grey Fog
 983 Slate



421



597

793

853

983

51867 OSLO REVERSIBLE PILE JACKET

USD \$150

Sizes: S-2XL
Fitting: Regular
CB/Inseam: 74cm
Insulation:
Water column:
Weight: 350G/M2
Fabric: 100% Polyester
Features:
 • Pile Exterior
 • Water repellent inner fabric
 • Reversible
 • YKK® zipper

Colours:
 421 Lav Green
 597 Navy



597



421

51806 JUELL PILE JACKET

USD \$140

Sizes: S-2XL
Fitting: Regular
CB/Inseam: 73cm
Insulation:
Water column:
Weight: 320G/M2
Fabric: 100% Polyester
Features:
 • High loft brushed 2-sided fleece
 • Softshell cuffs and panels
 • High pocket placement for easy entrance when wearing a backpack
 • Pockets with zip
 • High collar

Colours:
 421 Lav Green
 597 Navy
 981 Ebony



981



597

421

51849 FEATHER PILE JACKET

USD \$120

Sizes: S-2XL
Fitting: Regular
CB/Inseam: 74cm
Insulation:
Water column:
Weight: 285G/M2
Fabric: 100% Polyester
Features:
 • Lightweight pile
 • 2-sided brushed fleece
 • Full Chest zip
 • Lycra edge band at neck, cuff and hem
 • YKK® zipper

Colours:
 597 Navy
 793 Redwood
 853 Grey Fog



597



793



853



51811 HH MERINO HOODED JACKET

USD \$250

Sizes: S-2XL
 Fitting: Regular
 CB/Inseam: 71cm
 Insulation: Water column:
 Weight: 300G/M2
 Fabric: 100% Merino Wool
 Colours: 980 Ebony

- Features:**
- 100% Merino Wool Fleece
 - Pockets with zip
 - Merino wool pocket linings
 - YKK® Zippers
 - Snug fit hood
 - Brushed inside



980

51802 MARKA WOOL SWEATER

USD \$150

Sizes: S-2XL
 Fitting: Regular
 CB/Inseam: 68cm
 Insulation: Weight:
 Fabric: 100% Lambswool
 Colours: 482 Beluga, 597 Navy, 980 Ebony Melange

- Features:**
- 100% Wool
 - Knitted wool midlayer
 - YKK® Zippers
 - High neck collar
 - Thumb holes
 - Waffle knit exterior
 - Brushed Fleece interior
 - 1/2 Zip chest construction



482



597

980

51893 DAYBREAKER LOGO HOODIE

USD \$65

Sizes: S-2XL
 Fitting: Relaxed
 CB/Inseam: 76cm
 Insulation: Water column:
 Weight: 160G/M2
 Fabric: 100% Recycled Polyester
 Colours: 421 Lav Green, 597 Navy, 639 Electric Blue, 990 Black

- Features:**
- Polartec®
 - Hood for added warmth and comfort
 - Kangaroo pocket
 - Flatlock seams for low bulk
 - Embossed HH® logo



421



597

639

990

51598 DAYBREAKER FLEECE JACKET

USD \$65

Sizes: S-2XL
 Fitting: Regular
 CB/Inseam: 74cm
 Insulation: Water column:
 Weight: 160G/M2
 Fabric: 100% Recycled Polyester
 Colours: 222 Alert Red, 300 Patrol Orange, 421 Lav Green, 598 Navy, 639 Electric Blue, 990 Black, 994 Graphite Blue

- Features:**
- Polartec®
 - Full YKK® coil zip front opening
 - YKK® coil zipped hand pockets
 - Flatlock seams for low bulk
 - HH® logo embroidery at the chest



222



990

994



300

421

598

639

MEN'S MIDLAYER

50844 DAYBREAKER 1/2 ZIP FLEECE

USD \$55

Sizes:
S-2XL

Fitting:
Regular

CB/Inseam:
74cm

Insulation:

Weight:
160G/M2

Fabric:
100% Recycled
Polyester

Features:

- Polartec®
- YKK® coil 1/2 zip front opening
- Flatlock seams for low bulk
- HH® logo embroidery at the chest

Colours:
222 Alert Red
300 Patrol Orange
421 Lav Green
599 Navy
639 Electric Blue
990 Black
994 Graphite Blue



421



990

994



300

222

599

639

51831 DAYBREAKER FLEECE VEST

USD \$50

Sizes:
S-2XL

Fitting:
Regular

CB/Inseam:
72cm

Insulation:

Water column:

Weight:
160G/M2

Fabric:
100% Recycled
Polyester

Polartec®

- Flatlock seams for low bulk
- HH® embroidery
- Hand pockets with ventilation mesh

Colours:
990 Black



990

51742 DAYBREAKER FLEECE PANT

USD \$60

Sizes:
S-2XL

Fitting:
Regular

CB/Inseam:
80cm

Insulation:

Water column:

Weight:
160G/M2

Fabric:
100% Recycled
Polyester

Features:

- Polartec® 100g
- Elasticated waist
- Flatlock seams for low bulk
- HH logo embroidery at the chest

Colours:
990 Black



990

53542 JPN 3IN1 PARKA

USD \$450

Sizes: S-2XL
Fitting: Relaxed
CB/Inseam:

Insulation: Water column: 22000 / 25000
Weight:

Fabric: 100% Polyester

Colours: 597 Navy
 857 Pelican

- Features:**
- HELLY TECH® Performance fabric
 - 3 layer fabric construction outer jacket
 - Button out quilted 60g Primaloft® insulator
 - Two large main pockets on outer jacket with hidden snap closure
 - YKK® front zipper with storm flap for extra protection
 - Adjustable cuffs on outer jacket
 - Fishtail design with drawcord adjustment
 - Two front pockets with snap on inner jacket
 - Inside JPN storytelling print
 - Embroidered HH® logo on sleeve



- HELLY TECH® Performance fabric
- 3-layer fabric construction
- Quilted Primaloft® Insulator
- YKK® zippers

597



857

The JPN collection is inspired by Helly Hansen's long presence in Japan. The 3-in-1 Parka is both waterproof, warm, stylish and comfortable.

JPN CONNECTION

This collection is the result of an inspired collaboration between Helly Hansen Japan and Helly Hansen Norway. Focusing on the similarities of Japanese and Norwegian craftsmanship, the designs reflect the attention to details and pursuit of simplicity, elevating raw beauty and the shared passion for water and natural light.

53566 JPN PUFFY JACKET

USD \$350

Sizes: S-2XL
Fitting: Regular
CB/Inseam:

Insulation: Water column: >11000
Weight:

- Fabric:** Shell: 100% Polyamide - Lining: 100% Polyester - Insulation: 100% Polyester
- Features:**
- Puffy synthetic insulation
 - Removable and adjustable Hood
 - YKK® Zippers
 - Two front pockets

Colours: 488 Scarab Green
 597 Navy
 640 Ice Blue



488



597



640

53544 JPN CORD JACKET

USD \$250

Sizes: S-2XL
Fitting: Regular
CB/Inseam:

Insulation: Water column:
Weight:

- Features:**
-

Fabric:

Colours: 597 Navy
 857 Pelican



597



857



53408 JPN RAIN JACKET

USD \$180

Sizes: S-2XL
Fitting: Regular
CB/Inseam:

Insulation:
Water column: >10000
Weight:

Fabric:
 100% Polyester

Colours:
 597 Navy
 598 Navy Denim
 703 Sandstorm
 Print

- Features:**
- HELLY TECH® Protection fabric
 - 2-layer fabric construction
 - Fully taped
 - Fully lined
 - YKK® zippers
 - Hand pockets
 - Bottom and hood adjustments



597



598



703

53545 JPN QUILTED 1/2 ZIP HOODIE

USD \$180

Sizes: S-2XL
Fitting: Regular
CB/Inseam:

Insulation:
Water column:
Weight:

Fabric:
 Main: 100% Polyester - Lining:
 100% Polyester
 - Insulation: 80%
 Recycled Polyester,
 20% Polyester

Colours:
 597 Navy
 857 Pelican

- Features:**
- Synthetic padded quilted main fabric
 - Adjustable hood
 - Two front pockets



597



857

MEN'S URBAN



53145 CHILL PARKA

USD \$350

Sizes: S-2XL
Fitting: Regular
CB/Inseam: 78cm

Insulation: Primaloft® Black
Water column: 9700/15000
Weight:

Fabric:
 Face: 100% Polyester / Back: 100% Polyurethane

Colours:
 217 Spice
 597 Navy
 841 Penguin
 990 Black

- Features:**
- HELLY TECH® Protection fabric
 - Waterproof, windproof and breathable
 - Strategically taped seams for protection against the elements
 - Durable Water Repellency (DWR) treatment
 - Fully Insulated, Primaloft® Black Insulation, 133g/m² in body, 100g/m² in sleeves
 - Featuring our H2Flow™ Technology



217



597



841



990

53324 HUDSON PARKA

USD \$350

Sizes: S-2XL
Fitting: Regular
CB/Inseam: 88cm

Insulation: Primaloft® Black
 Eco insulation
 133gr
Water column:
Weight:

Fabric:
 Face: 65% Polyester, 35% Cotton / Back: 100% Polyurethane

Colours:
 482 Beluga
 857 Pelican
 990 Black

- Features:**
- HELLY TECH® Protection
 - Fully seam sealed
 - Windchill table print inside
 - Life Pocket™ at chest
 - Adjustable hood with comfortable pile lining
 - Primaloft® Black, 133g insulation
 - two cargo hand pockets with top and side entry
 - stash pocket inside
 - rib cuffs



482



857



990

53167 BARENTS PARKA

USD \$400

Sizes: S-2XL
Fitting: Regular
CB/Inseam: 97cm

Insulation:
Water column:
Weight:

Fabric:
 Face: 100% Polyester / Back : 100% Polyurethane

Colours:
 217 Spice
 483 Beluga
 597 Navy
 949 Grey Melange

- Features:**
- Waterproof, windproof and breathable fabric
 - Strategically taped seams for protection against the elements
 - Durable Water Repellency (DWR) treatment
 - Fully insulated with high loft synthetic insulation
 - Pile lined hood with detachable faux fur
 - Inner stash pocket
 - Multiple exterior pockets
 - Hand warmer pockets
 - Inner chest pocket
 - Adjustable hood



217



483



597



949

53491 TROMSOE PARKA

USD \$375

Sizes: S-2XL
Fitting: Regular
CB/Inseam:

Insulation:
Water column: 5000/7600
Weight:

Fabric:
 Shell: 100% Polyamide - Lining: 100% Polyester - Faux fur: 100% Modacrylic - Insulation: 80% Recycled Polyester, 20% Polyester

Colours:
 482 Beluga
 603 North Sea Blue
 857 Pelican
 990 Black

- Features:**
- Primaloft Black Eco 80% Recycled / 170 grams
 - YKK® Zipper
 - Removable Premium faux fur
 - Double cuffs
 - Chest pocket with zip
 - two front cargo pockets
 - No-seam shoulder reinforcement



482



603



857



990

53150 SVALBARD PARKA

USD \$300

Sizes: S-2XL
Fitting: Regular
CB/Inseam: 88cm

Insulation: Primaloft® Black Eco insulation 133gr
Water column: 14000/20000
Weight:

Fabric:
 Face: 100% Polyamide / Back: 100% Polyurethane

Colours:
 162 Red
 483 Beluga
 484 Beluga Camo
 597 Navy
 857 Pelican
 990 Black

- Features:**
- HELLY TECH® Protection fabric
 - Waterproof, windproof and breathable
 - Fully seam sealed construction
 - Durable Water Repellency (DWR) treatment
 - Primaloft® Black insulation, 133g/m² in body and 100g/m² in sleeves
 - Multiple exterior pockets
 - Adjustable hood
 - Detachable faux fur
 - Articulated arms
 - Wrist gaiters
 - Inner chest pocket with zip closure



162



990



483



484



597



857

53181 URBAN LONG JACKET

USD \$300

Sizes: S-2XL
Fitting: Regular
CB/Inseam: 86cm

Insulation: Primaloft® Black Eco 100 gr
Water column: 5000/7600
Weight:

Fabric:
 Face: 100% Polyamide / Back: 100% Thermoplastic Polyurethane

Colours:
 217 Spice
 482 Beluga
 990 Black

- Features:**
- HELLY TECH® Protection
 - Waterproof, windproof and breathable
 - Fully seam sealed
 - Durable Water Repellency (DWR) treatment
 - Fully Insulated, Primaloft® 100 gr
 - Wrist gaiters for extra comfort and warmth
 - Multiple exterior pockets
 - Cargo pockets with both top and side entry
 - Inner chest pocket
 - Inner stash pocket
 - Adjustable fixed hood



217



482



990

53495 URBAN LINER

USD \$200

Sizes: S-2XL
Fitting: Regular
CB/Inseam:

Insulation: **Water column:** **Weight:**

Fabric:
 Shell: 100% Polyester - Lining
 2: 100% Polyester - Insulation: 100% Recycled Polyester

Colours:
 300 Patrol Orange
 349 Arrowwood
 482 Beluga
 597 Navy
 990 Black

- Features:**
- Doubleweave stitch free channels for insulation
 - 100% Recycled insulation
 - Hand pockets with hidden snap button closure
 - All seams inside banded with self fabric
 - Inside pocket
 - Mono material information print inside
 - HH@ logo on sleeve



300



990



597



349



482

Built on the idea of making garment recycling easier, this super comfortable insulator combines Urban design lines with singular material construction. The entire jacket, except the zipper, is made of polyester that can easily be recycled. Stitch free quilting, recycled light weight polyester insulation and a soft main fabric.

MONO MATERIAL

100% Recyclable

This garment is made with one single material, without any mixed fibers. Using mono material in a garment makes it easier to recycle and a better resource in a circular system, where the goal is textile to textile recycling.

53496 URBAN HOODED LINER

USD \$230

Sizes: S-2XL
Fitting: Regular
CB/Inseam:

Insulation: **Water column:** **Weight:**

Fabric:
 Shell: 100% Polyester - Lining
 2: 100% Polyester - Insulation: 100% Recycled Polyester

Colours:
 300 Patrol Orange
 482 Beluga
 597 Navy
 990 Black

- Features:**
- Doubleweave stitch free channels for insulation
 - 100% Recycled insulation
 - Hand pockets with hidden snap button closure
 - All seams inside banded with self fabric
 - Inside pocket
 - Mono material information print inside
 - HH@ logo on sleeve



300



482



597



990

53508 RIGGING COAT

USD \$350

Sizes: S-2XL
Fitting: Regular
CB/Inseam: 102 cm

Insulation: Primaloft® black eco 100 gr
Water column: 12500/4800
Weight:

Fabric:

- Outer Jacket: HELLY TECH® Protection fabric
- waterproof, windproof and breathable fabric
- fully seam sealed
- adjustable hood
- hand warmer pocket
- reflective fold up at sleeve
- adjustable cuffs
- Inner jacket : 100% Primaloft black insulation
- hand pockets.

Colours:
 484 Beluga Camo
 597 Navy
 990 Black



484



597



990

URBAN ACTIVE

Performance-minded rain wear concept merging active, corporate and casual lifestyle aimed at the true urbanite. Durable enough for daily commuting, muted enough for work, and cool enough for after hours.



53509 UTILITY INSULATED PARKA

USD \$275

Sizes: S-2XL
Fitting: Regular
CB/Inseam:

Insulation:
Water column: 10900/14200
Weight:

Fabric:
 Shell: 100% Polyamide - Lining: 100% Polyester
 - Insulation: 80% Recycled Polyester, 20% Polyester

Features:

- Helly Tech® Performance
- 60g Primaloft®
- Chest handwarmer pockets
- Two front cargo pockets with additional side pockets with snap
- Fold up reflective
- Adjustable hood

Colours:
 482 Beluga
 597 Navy
 990 Black



PROTECTION
 This performance-driven rainwear concept adapts seamlessly to the active, corporate and casual lifestyles of true urbanites. Durable and subtle for daily commuting and work, yet stylish for after hours, this is the ideal rainwear for all occasions.



53511 UTILITY INSULATED RAIN JACKET

USD \$240

Sizes: S-2XL
Fitting: Regular
CB/Inseam:

Insulation:
Water column: 10900/14200
Weight:

Fabric:
 Shell: 100% Polyamide - Lining: 100% Polyester
 - Insulation: 80% Recycled Polyester, 20% Polyester

Features:

- Helly Tech® Performance
- 60g Primaloft®
- Chest "Napoleon" pocket
- Two front cargo pockets
- Fold up reflective
- Adjustable hood

Colours:
 482 Beluga
 597 Navy
 990 Black



53416 URBAN RAIN JACKET

USD \$140

Sizes: S-2XL
Fitting: Regular
CB/Inseam:

Insulation:
Water column: 6100/8500
Weight:

Fabric:
 100% Polyamide

Features:

- 2-layer HELLY TECH® Protection fabric
- Fully taped
- hand pockets with YKK® zipper closure
- YKK® Metalux front zipper with back placket for extra protection
- hood adjustment
- cuff adjustment
- ventilation on back
- HH® logo

Colours:
 482 Beluga
 597 Navy
 990 Black



53415 UTILITY RAIN JACKET

USD \$200

Sizes: S-2XL
Fitting: Regular
CB/Inseam:

Insulation:
Water column: 10900/14200
Weight:

Fabric:
 100% Polyamide

Features:

- 2-layer HELLY TECH® Protection fabric
- Fully taped
- packable hood
- Chest pocket with YKK® zipper closure
- Hand pockets with snap closure
- YKK® Vislon front zipper with back placket for extra protection
- hood adjustment
- cuff adjustment
- ventilation on back
- inner stash pocket
- HH® logo

Colours:
 482 Beluga
 597 Navy
 990 Black



53510 DUBLINER INSULATED LONG JACKET

USD \$220

Sizes: S-2XL
Fitting: Regular
CB/Inseam:
Insulation: 12500/4800
Weight:
Fabric: Shell: 100% Polyester - Lining: 100% Polyester - Insulation body: 80% Recycled Polyester, 20% Polyester
Features:
 • HELLY TECH® Protection
 • Adjustable cuffs
 • Fold up reflective
 • Packable hood
 • Chest "Napoleon" pocket
 • YKK® Zippers

482 Beluga
 597 Navy
 990 Black



482



597



990

53117 DUBLINER INSULATED JACKET

USD \$175

Sizes: S-2XL
Fitting: Regular
CB/Inseam: 76cm
Insulation: 12500/4800
Weight:
Fabric: Face: 100% Polyester / Back: 100% Polyurethane
Features:
 • HELLY TECH® Protection
 • Waterproof, windproof and breathable
 • 2-layer fabric construction
 • Fully seam sealed
 • Durable Water Repellency (DWR) treatment
 • Lined for comfort
 • Quick dry lining
 • Packable hood
 • One hand hood adjustments
 • Adjustable cuffs
 • Exterior and interior pockets
 • Velcro free design

597 Navy
 990 Black



597



990

62643 DUBLINER JACKET

USD \$130

Sizes: S-2XL
Fitting: Regular
CB/Inseam: 75cm
Insulation: 12500/4800
Weight:
Fabric: Shell: 100% Polyester - Lining: 100% Polyester - Lining 2: 100% Polyester
Features:
 • HELLY TECH® Protection fabric
 • Waterproof, windproof and breathable
 • 2-layer construction
 • Fully seam sealed
 • Durable Water Repellency (DWR) treatment
 • Lined for comfort
 • Quick dry lining
 • Packable hood
 • Adjustable hood
 • Adjustable cuffs
 • Exterior and interior pockets
 • YKK® quality zippers

597 Navy
 990 Black



597



990

62652 DUBLINER PANT

USD \$75

Sizes: S-2XL
Fitting: Regular
CB/Inseam: 80cm
Insulation: 12500/4800
Weight:
Fabric: Face: 100% Polyester / Back: 100% Polyurethane
Features:
 • HELLY TECH® Protection fabric
 • Waterproof, windproof and breathable
 • 2-layer construction
 • Fully seam sealed
 • Durable Water Repellency (DWR) treatment
 • Lined for comfort
 • Quick dry lining
 • YKK® quality zippers
 • DWR treatment

990 Black



990



62368 SQUAMISH CIS JACKET

USD \$225

Sizes: S-2XL
Fitting: Regular
CB/Inseam: 78cm

Insulation: 12500/4800
Water column: 12500/4800
Weight:

Fabric:
 Face: 100% Polyester / Back: 100% Polyurethane

Colours:
 162 Red
 483 Beluga
 598 Navy
 990 Black

Features:

- HELLY TECH® Protection
- Component Insulation System 3-in-1 Jacket
- Waterproof, windproof and breathable
- 2-layer fabric construction
- Fully seam sealed
- Durable Water Repellency (DWR) treatment
- Primaloft® Black 100g liner
- Lined for comfort
- Quick dry lining
- Fixed hood
- One hand hood adjustments



162



483

598

990

62047 SEVEN J JACKET

USD \$100

Sizes: S-2XL
Fitting: Regular
CB/Inseam: 76cm

Insulation: 12500/4800
Water column: 12500/4800
Weight:

Fabric:
 100% Polyester

Colours:
 300 Patrol Orange
 596 Navy
 964 Charcoal
 992 Black

Features:

- HELLY TECH® Protection fabric
- Waterproof, windproof and breathable
- 2-layer construction
- Fully seam sealed
- Durable Water Repellency (DWR) treatment
- Lined for comfort
- Quick dry lining
- Fixed hood
- Adjustable hood
- Front storm flap
- YKK® front zipper



300



596

964

992

62372 SEVEN J PANT

USD \$75

Sizes: S-2XL
Fitting: Regular
CB/Inseam: 80cm

Insulation: 12500/4800
Water column: 12500/4800
Weight:

Fabric:
 Shell: 100% Polyester - Lining 2: 100% Polyester - Lining: 100% Polyester

Colours:
 990 Black

Features:

- HELLY TECH® Protection fabric
- Waterproof, windproof and breathable
- 2-layer construction
- Fully seam sealed
- Durable Water Repellency (DWR) treatment
- Lined for comfort
- Quick dry lining
- Elastic adjustable waist
- Bottom Leg zip opening
- Zipper opening on lower legs



990

53340 MOSS INSULATED RAIN COAT

USD \$180

Sizes: S-2XL
Fitting: Regular
CB/Inseam: 84cm

Insulation: 12500/4800
Water column: 12500/4800
Weight:

Fabric:
 Face: 100% Polyurethane / Back: 100% Polyester

Colours:
 344 Essential Yellow
 421 Lav Green
 597 Navy

Features:

- Helox+® technology
- PU fabric construction
- Fully wind and waterproof
- Welded seams
- Snap out full pile lining for extra warmth, comfort and versatility
- Back yoke with ventilation holes underneath for extra comfort
- Front placket with hidden snap button closure and YKK® Vislon zipper down front
- Hanging hood with cord adjustment
- Hand pockets with welded flap and snap button closure



344



421

597

53265 MOSS RAIN COAT

USD \$110

Sizes: S-2XL
Fitting: Regular
CB/Inseam: 84cm

Insulation: **Water column:** 18800/0
Weight:

Fabric:
 Face: 100% Polyurethane
 / Back: 100% Polyester
Colours:
 344 Essential Yellow
 597 Navy

Features:

- PU Main fabric
- Two front pockets
- Ventilation holes under back yoke
- Front button construction
- PU Repair kit
- Welded seams



53267 MOSS JACKET

USD \$65

Sizes: S-2XL
Fitting: Regular
CB/Inseam: 78 cm

Insulation: **Water column:** 8200/400
Weight:

Fabric:
 Face: 100% Polyurethane
 / Back: 100% Polyester
Colours:
 344 Essential Yellow
 990 Black

Features:

- PU Main fabric
- Full front zip
- Two front pockets
- Welded seams
- PU Repair kit



53268 MOSS PANT

USD \$40

Sizes: S-2XL
Fitting: Regular
CB/Inseam: 83cm

Insulation: **Water column:** 8200/400
Weight:

Fabric:
 Face: 100% Polyurethane
 / Back: 100% Polyester
Colours:
 990 Black

Features:

- PU Main fabric
- Inside center front waist cord for adjustment
- Welded seams
- PU repair kit



34113 AEGIR OCEAN JACKET

USD \$1,000

- Sizes:** S-2XL
Fitting: Regular
CB/Inseam: 100cm
- Insulation:** **Water column:** 35000mm
Weight:
- Fabric:** 100% Cotton
- Colours:** 222 Alert Red
- Features:**
- HELLY TECH® Professional fabric
 - 5-layer construction
 - Fully seam sealed
 - Durable Water Repellency (DWR) treatment
 - 3/4 Length
 - High collar
 - Polartec® recycled fleece
 - Adjustable hood
 - EN471 Hi Vis
 - Double storm flap
 - YKK® zippers
 - Latex sealed double cuffs



AEGIR

Named after the Norse God of the ocean, the Aegir collection is designed for and developed with our professionals, with a racing mindset. Made for freedom of movements, the Aegir collection is light and agile, with 3-ply Hellytech® Professional fabric and an ergonomic collar and hood. The fabric is waterproof, breathable and windproof with fully sealed seams.

33869 AEGIR RACE JACKET

USD \$700

- Sizes:** S-2XL
Fitting: Regular
CB/Inseam: 83,50cm
- Insulation:** **Water column:** 25000mm
Weight:
- Fabric:** 100% Polyamide
- Colours:** 222 Alert Red
- Features:**
- HELLY TECH® Professional fabric
 - 4-layer construction
 - Fully seam sealed
 - Durable Water Repellency (DWR) treatment
 - 3/4 Length
 - High collar
 - Fleece collar
 - Adjustable hood
 - EN471 Hi Vis
 - Double storm flap
 - YKK® zippers
 - Adjustable double cuffs



33976 AEGIR RACE SMOCK LIGHT

USD \$500

- Sizes:** S-2XL
Fitting: Regular
CB/Inseam: 72cm
- Insulation:** **Water column:** 25000mm
Weight:
- Fabric:** Face: 100% Polyamide / Back: 100% Polyurethane
- Colours:** 222 Alert Red
- Features:**
- HELLY TECH® Professional fabric
 - 4-layer construction
 - Fully seam sealed
 - Durable Water Repellency (DWR) treatment
 - Hip Length
 - High protective collar
 - Polartec® recycled fleece lining
 - Adjustable hood
 - EN471 Hi Vis
 - Adjustable waist
 - YKK® zippers
 - Rubber seals in cuffs and neck

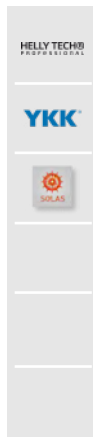

33871 AEGIR RACE SALOPETTE

USD \$450

- Sizes:** S-2XL
Fitting: Regular
CB/Inseam: 79cm
- Insulation:** **Water column:** 25000mm
Weight:
- Fabric:** Face: 100% Polyamide / Back: 100% Polyurethane
- Colours:** 980 Ebony
- Features:**
- HELLY TECH® Professional fabric
 - 3-layer construction
 - Fully seam sealed
 - Durable Water Repellency (DWR) treatment
 - Reinforcement fabric on seat and knees
 - Over shoulder design for minimal bulk
 - YKK® two-way front zipper
 - Adjustable waist
 - Cargo pockets
 - Adjustable hem
 - Stealth cuff leg opening





MEN'S WATERSPORT



34005 AEGIR OCEAN DRY TOP

USD \$1,100



Sizes: S-2XL
Fitting: Regular
CB/Inseam: 75cm

Insulation: 35000mm
Water column: 35000mm
Weight:

Fabric: 100% Cotton

Colours: 222 Alert Red

- Features:**
- HELLY TECH® Professional fabric
 - 5-layer construction
 - Fully seam sealed
 - Durable Water Repellency (DWR) treatment
 - Adjustable length
 - High collar
 - Polartec® recycled fleece lining
 - Adjustable hood
 - EN471 Hi Vis
 - Adjustable waist
 - Zip-off protective skirt
 - YKK® zippers



222

34006 AEGIR OCEAN SMOCK

USD \$1,100



Sizes: S-2XL
Fitting: Regular
CB/Inseam: 75cm

Insulation: 35000mm
Water column: 35000mm
Weight:

Fabric: Face: 100% Polyamide / Back: 100% Polyurethane

Colours: 222 Alert Red

- Features:**
- HELLY TECH® Professional fabric
 - 5-layer construction
 - Fully seam sealed
 - Durable Water Repellency (DWR) treatment
 - Adjustable waist
 - Rubber seals on cuffs and neck
 - Adjustable waist
 - SOLAS-approved reflective elements
 - Kangaroo pocket
 - Articulated sleeves for optimal mobility

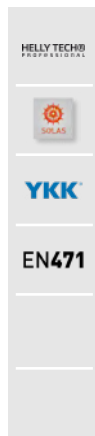

222

34007 AEGIR OCEAN TROUSERS

USD \$800



Sizes: S-2XL
Fitting: Regular
CB/Inseam: 82cm

Insulation: 35000mm
Water column: 35000mm
Weight:

Fabric:
 Face: 100% Polyamide / Back: 100% Polyurethane

Colours:
 222 Alert Red
 980 Ebony

Features:

- HELLY TECH® Professional fabric
- 5-layer construction
- Fully seam sealed
- Durable Water Repellency (DWR) treatment
- Reinforcement fabric on seat and knees
- High back panel for protection
- YKK® two-way front zipper
- Adjustable suspenders
- Adjustable waist
- Cargo pocket
- Adjustable hem
- PU seal on hem



31706 AEGIR OCEAN DRY SUIT

USD \$1,500



Sizes: S-2XL
Fitting: Regular
CB/Inseam: 91cm

Insulation: 35000mm
Water column: 35000mm
Weight:

Fabric:
 100% Polyester

Colours:
 222 Alert Red

Features:

- HELLY TECH® Professional fabric
- 5-layer construction
- Fully seam sealed
- Durable Water Repellency (DWR) treatment
- Full suit
- High collar
- Polartec® recycled fleece lining
- Adjustable hood
- EN471 Hi Vis
- Double storm flap
- YKK® zippers
- Latex sealed neck and cuffs



34093 ARCTIC OCEAN PARKA

USD \$700



Sizes: XS-2XL
Fitting: Regular
CB/Inseam: 86 cm

Insulation: 100% Recycled quick dry polyester insulation
Water column: 10000mm
Weight:

Fabric:
 Shell: 100% Polyamide - Lining: 100% Polyamide - Insulation: 100% Recycled Polyester

Colours:
 597 Navy
 981 Ebony

Features:

- HELLY TECH® Performance fabric
- Waterproof, windproof, warm and breathable
- 2-layer construction
- Fully seam sealed
- Durable Water Repellency (DWR) treatment
- Quick dry recycled polyester insulation
- YKK® Vislon® Heavy duty non corrosive zipper
- Adjustable hood
- EN471 Hi Vis
- Double storm flap
- Profiled High collar



Made for winter sailing and adventures on in the Arctic Ocean this Parka is a fully featured and insulated sailing Jacket developed with our sailing ambassadors sailing on the northern coasts of Norway

ARCTIC OCEAN SAILING

The Arctic Ocean Collection offers our best technologies to meet the challenges of the cold sea and shores. This collection has been designed with the insights for decades of sailing professionals operation on the cold waters and are made for both sailing and everyday life along the northern coasts and ocean.

34059 ARCTIC OCEAN PUFFY JACKET

USD \$500

Sizes: XS-2XL
Fitting: Regular
CB/Inseam: 72cm

Insulation: 100% Recycled quick dry polyester insulation
Fabric: 100% Polyester

Colours: 597 Navy
 980 Ebony

Water column: 10000mm
Weight:

Features:

- HELLY TECH® Performance fabric
- Waterproof, windproof, warm and breathable
- 2-layer construction
- Fully seam sealed
- Durable Water Repellency (DWR) treatment
- Quick dry recycled polyester insulation
- YKK® Vislon® Heavy duty non corrosive zipper
- Adjustable hood



980



597

34074 ARCTIC OCEAN HYBRID INSULATOR

USD \$200

Sizes: S-2XL
Fitting: Regular
CB/Inseam: 76cm

Insulation: 100% polyester quick dry insulation
Fabric: 100% Polyester

Colours: 597 Navy
 980 Ebony

Water column:
Weight:

Features:

- Hybrid construction
- Durable Water Repellency (DWR) treatment
- stitch less baffle fabric technology
- Quick dry polyester insulation
- Knit face Fleece sleeve panels
- Chest pocket with YKK® zipper
- Hand Warmer pockets with YKK® zipper
- Arctic ocean badge on upper arm
- HH Logo at chest
- Fully insulated hood
- Elastic binding at bottom sleeve



597



980

34063 ARCTIC OCEAN WINDPROOF PILE

USD \$160

Sizes: S-2XL
Fitting: Regular
CB/Inseam: 72cm

Insulation:
Water column:
Weight:

Fabric: Shell: 100% Polyester - Shell 2: 100% Polyamide

Colours: 597 Navy
 980 Ebony

Features:

- Classic Helly Hansen Pile
- Windproof overlay and liner in body shoulders and front
- YKK® Vislon® full zip in Center front
- Chest pocket with YKK® zipper
- Hand Warmer Pocket with YKK® zippers
- Hypalon Hanger loop
- Elastic binding at bottom Hem and sleeves
- Arctic ocean badge on upper arm
- HH Logo at chest
- Helly Hansen Logo at back of collar



980



597

34062 ARCTIC OCEAN WINDPROOF SWEATER

USD \$220

Sizes: S-2XL
Fitting: Regular
CB/Inseam: 74cm

Insulation:
Water column:
Weight:

Fabric: Shell: 60% Merino Wool, 40% Polyamide

Colours: 458 Uniform Green
 597 Navy

Features:

- Hardwearing chunky wool knit
- Overlay reinforcement at shoulder
- Arctic Ocean by Helly Hansen Artwork
- 1/2 zip knitted Rib Collar with YKK® Zipper
- Knitted Rib at sleeves and bottom hem
- Overlay reinforcement at shoulder and elbow



597



458



34095 ARCTIC SHORE SWEATER

USD \$150

Sizes: 3XS-6XL
Fitting: Regular
CB/Inseam: 71cm

Insulation:
Water column:
Weight:

Fabric:
 80% Wool, 20% Polyamide

Colours:
 597 Navy
 949 Grey Melange

Features:

- Hardwearing chunky wool knit
- Overlay reinforcement at shoulder and elbow
- Arctic Ocean by Helly Hansen Artwork
- Knitted Rib at sleeves and bottom hem



597



949

33907 SKAGEN OFFSHORE JACKET

USD \$350

Sizes: S-2XL
Fitting: Regular
CB/Inseam: 82cm

Insulation:
Water column: 10000mm
Weight:

Fabric:
 100% Polyester

Colours:
 147 Cherry Tomato
 597 Navy

Features:

- HELLY TECH® Performance fabric
- Waterproof, windproof and breathable
- 2-layer construction
- Fully seam sealed
- Durable Water Repellency (DWR) treatment
- Quick dry Mesh lining
- Lower back reinforcement
- Adjustable hood
- EN471 Hi Vis
- Double storm flap
- Profiled High collar
- Fleece lining in collar
- Adjustable double cuff seals

HELLY TECH®
PERFORMANCE

EN471

YKK



147



597

SAILING ESSENTIALS

The perfect balance between technical and lifestyle. This collection has been especially designed for the classic marine sailor with a cruising mindset. The 2ply HellyTech® Professional and Performance levels has solid and functional built, drawing experience from our professional line.

33908 SKAGEN OFFSHORE BIB

USD \$250

Sizes: S-2XL
Fitting: Regular
CB/Inseam: 81,50cm

Insulation:
Water column: 10000mm
Weight:

Fabric:
 Face: 100% Polyamide / Back: 100% Polyurethane

Colours:
 980 Ebony

Features:

- HELLY TECH® Performance fabric
- Waterproof, windproof and breathable
- 2-layer construction
- Fully seam sealed
- Durable Water Repellency (DWR) treatment
- Quick dry Mesh lining
- Quick dry inside
- Reinforcement fabric on seat and knees
- High back panel for protection
- YKK® two-way front zipper
- Adjustable suspenders
- Adjustable waist
- Right Cargo pocket with YKK® Aqua guard® water repellent zip

HELLY TECH®
PERFORMANCE

YKK



980

34156 PIER 3.0 JACKET

USD \$240

Sizes: S-2XL
Fitting: Regular
CB/Inseam: 86,5cm

Insulation:
Water column: 21000/12000
Weight:

Fabric:
 100% Polyester

Colours:
 222 Alert Red
 597 Navy

Features:

- HELLY TECH® Performance fabric
- Waterproof, windproof and breathable
- Profiled High collar with
- Adjustable double cuff seals
- Fleece-lined hand warmer pockets

HELLY TECH®
PERFORMANCE

EN471

YKK



222



597

34157 PIER 3.0 BIB

USD \$160

Sizes: S-2XL
Fitting: Regular
CB/Inseam: 83,5cm

Insulation: Water column: 21000/12000
Weight:

Fabric:
 Face: 100% Polyamide / Back: 100% Polyurethane

Colours:
 597 Navy
 980 Ebony

HELLY TECH® PERFORMANCE

YKK®

Features:

- HELLY TECH® Performance fabric
- Waterproof, windproof and breathable
- YKK® two-way front zipper
- Reinforcement fabric on seat and knees
- Articulated seat and knees for optimal mobility



34173 SALTRO JACKET

USD \$220

Sizes: S-2XL
Fitting: Regular
CB/Inseam: 76cm

Insulation: Water column: 15000mm
Weight:

Fabric:
 86% Polyester, 14% Elastane

Colours:
 421 Lav Green
 597 Navy
 980 Ebony

HELLY TECH® PERFORMANCE

SOLAS

Features:

- HELLY TECH® Performance fabric
- Waterproof, windproof and breathable
- Handwarmer pockets
- Fleece collar
- D-ring for Engine kill cord



34040 HP RACING JACKET

USD \$200

Sizes: S-2XL
Fitting: Regular
CB/Inseam: 71,50cm

Insulation: Water column: 15000mm
Weight:

Fabric:
 Other materials

Colours:
 222 Alert Red
 421 Lav Green
 597 Navy
 980 Ebony

HELLY TECH® PERFORMANCE

YKK®

POLARTEC

GREEN FREE ZONE

HYDROPOWER

Features:

- HELLY TECH® Performance fabric
- Waterproof, windproof and breathable
- 2-layer construction
- Fully seam sealed
- Durable Water Repellency (DWR) treatment
- Lined for comfort
- Quick dry lining
- Dual hand pockets with brushed lining
- Adjustable cuffs
- Adjustable hem with drawcord

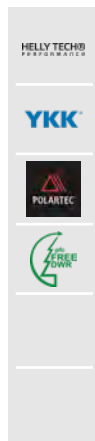

HYDROPOWER

Highly technical and modern, the Hydropower collection offers quality and function for high speed performance on water: Focusing on speed, aerodynamics and protection, this series features key technical marine functions. Its style and comfort are a tribute to the shared enjoyment of being in the water.

34041 HP RACING MIDLAYER JACKET

USD \$225

Sizes: S-2XL
Fitting: Regular
CB/Inseam: 71,50cm

Insulation: Water column: 15000mm
Weight:

Fabric:
 Face: 100% Polyester / Back: 100% Polyurethane

Colours:
 222 Alert Red
 421 Lav Green
 597 Navy
 980 Ebony

HELLY TECH® PERFORMANCE

lifaloft

YKK®

GREEN FREE ZONE

Features:

- HELLY TECH® Performance fabric
- Waterproof, windproof and breathable
- 2-layer construction
- Fully seam sealed
- Durable Water Repellency (DWR) treatment
- Lined for comfort
- Quick dry lining
- Hip length
- LIFALOFT™ insulation
- Dual hand pockets with brushed lining
- Adjustable cuffs
- Adjustable hem with drawcord



30263 CREW JACKET

USD \$155

CREW SERIES

Sizes: S-4XL
Fitting: Regular
CB/Inseam: 74cm
Insulation: 5000mm
Water column: 5000mm
Weight:
Features:
 • HELLY TECH® Protection fabric
 • Waterproof, windproof and breathable
 • 2-layer construction
 • Fully seam sealed
 • Durable Water Repellency (DWR) treatment
 • Lined for comfort
 • Quick dry lining
 • Hip length
 • Adjustable cuffs
 • Pockets with zip
 • Adjustable hem with drawcord
 • Embroider friendly
Fabric: 100% Polyester
Colours:
 222 Alert Red
 421 Lav Green
 597 Navy
 853 Grey Fog
 990 Black



853



421

597

222

990

30253 CREW MIDLAYER JACKET

USD \$165

Sizes: S-5XL
Fitting: Regular
CB/Inseam: 74cm
Insulation: 5000mm
Water column: 5000mm
Weight:
Features:
 • HELLY TECH® Protection fabric
 • Waterproof, windproof and breathable
 • 2-layer construction
 • Fully seam sealed
 • Durable Water Repellency (DWR) treatment
 • Lined for comfort
 • Quick dry lining
 • Hip length
 • Insulated with Polartec® 1gfleece lining
 • Dual hand pockets with brushed lining
 • Adjustable cuffs
 • Adjustable hem with drawcord
Fabric: 100% Polyester
Colours:
 222 Alert Red
 421 Lav Green
 597 Navy
 853 Grey Fog
 990 Black



597



421

222

853

990

33875 CREW HOODED JACKET

USD \$165

Sizes: S-2XL
Fitting: Regular
CB/Inseam: 74cm
Insulation: 5000mm
Water column: 5000mm
Weight:
Features:
 • HELLY TECH® Protection fabric
 • Waterproof, windproof and breathable
 • 2-layer construction
 • Fully seam sealed
 • Durable Water Repellency (DWR) treatment
 • Mesh-lined for comfort
 • Polartec® fleece-lined comfortable collar
 • Hip length,
 • Chest pockets with zip
 • Hand pockets with zip
 • Stow away hood in collar
 • Adjustable bottom hem
Fabric: Face: 100% Polyester / Back: 100% Polyurethane
Colours:
 222 Alert Red
 421 Lav Green
 597 Navy
 853 Grey Fog
 983 Slate
 990 Black



222



990

421

597

853

983

33874 CREW HOODED MIDLAYER JACKET

USD \$175

Sizes: S-2XL
Fitting: Regular
CB/Inseam: 74cm
Insulation: 5000mm
Water column: 5000mm
Weight:
Features:
 • HELLY TECH® Protection fabric
 • Waterproof, windproof and breathable
 • 2-layer construction
 • Fully seam sealed
 • Durable Water Repellency (DWR) treatment
 • Polartec® fleece lining for additional warmth
 • Polartec® fleece-lined comfortable collar
 • Hip length,
 • Chest pockets with zip
 • Hand pockets with zip
 • Stow away hood in collar
Fabric: Face: 100% Polyamide / Back: 100% Polyurethane
Colours:
 222 Alert Red
 421 Lav Green
 597 Navy
 853 Grey Fog
 983 Slate
 990 Black



421



990

222

597

853

983



34144 TEAM CREW MIDLAYER JACKET

USD \$165

Sizes: S-5XL
Fitting: Regular
CB/Inseam: 74cm

Insulation: 5000mm
Water column: 5000mm
Weight:

Fabric: 100% Cotton

Colours: 597 Navy

Features:

- HELLY TECH® Protection fabric
- Waterproof, windproof and breathable
- 2-layer construction
- Fully seam sealed
- Durable Water Repellency (DWR) treatment
- Lined for comfort
- Quick dry lining
- Hip length
- Insulated with Polartec® 100gfleece lining
- Dual hand pockets with brushed lining
- Adjustable cuffs



597

30270 CREW VEST

USD \$125

Sizes: S-4XL
Fitting: Regular
CB/Inseam: 74cm

Insulation: 5000mm
Water column: 5000mm
Weight:

Fabric: 100% Polyester

Colours: 597 Navy, 990 Black

Features:

- HELLY TECH® Protection fabric
- Waterproof, windproof and breathable
- 2-layer construction
- Fully seam sealed
- Durable Water Repellency (DWR) treatment
- Lined for comfort
- Polartec® 1gfleece lining
- Hip length cut
- Chest pockets with zip
- Adjustable bottom hem

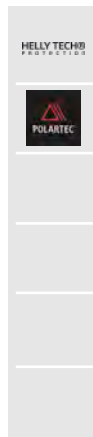

597



990

54412 CREW SOFTSHELL JACKET

USD \$150

Sizes: S-2XL
Fitting: Regular
CB/Inseam: 75cm

Insulation:
Water column:
Weight:

Fabric: 92% Polyester, 8% Elastane

Colours: 482 Beluga, 597 Navy, 980 Ebony

Features:

- Softshell fabric with membrane
- Lightweight water repellent side panel fabric
- Hand pockets with YKK® zipper
- YKK® Metalux front and chest pocket zipper
- Contrast piping at chest pocket
- Back yoke with contrast ribbon detail
- Printed Helly Hansen® logo at back collar
- Multiple HH® printed logos



482



597



980

54344 CREW INSULATOR JACKET

USD \$150

Sizes: S-2XL
Fitting: Regular
CB/Inseam: 73cm

Insulation:
Water column:
Weight:

Fabric: 100% Polyester

Colours: 222 Alert Red, 421 Lav Green, 597 Navy, 980 Ebony

Features:

- Wind resistant and water repellent polyester fabric
- Durable Water Repellency (DWR) treatment
- Primaloft® Black insulation
- YKK® Metalux front zipper
- Chest pocket and hand pockets with YKK® Metalux zip closure
- Contrast piping around collar edge and at chest pocket
- Back yoke with contrast ribbon detail
- Printed Helly Hansen® logo at back collar
- Multiple printed HH® logos



421



222



597



980

53584 ACTIVE HOODED MIDLAYER JACKET

USD \$160

Sizes: S-2XL

Fitting: Regular

CB/Inseam:

Insulation: 28000

Water column:

Weight:

Fabric: 100% Polyester

Features:

- HELLY TECH® Protection main fabric
- Packable hood with zip
- brushed fleece lining
- front pockets with zip
- chest pocket with zip
- YKK® zippers

Colours:
300 Patrol Orange
482 Beluga
597 Navy
990 Black



300



482

597

990

34142 CREW SWEATSHIRT

USD \$65

Sizes: S-2XL

Fitting: Regular

CB/Inseam: 71cm

Insulation:

Water column:

Weight:

Fabric: 100% polyester

Features:

- French Terry Cotton
- HH® logo Print
- Crew Neck Sweater
- Bottom hem and sleeve rib

Colours: 597 Navy



597

34043 HP FLEECE JACKET

USD \$120

Sizes: S-2XL

Fitting: Regular

CB/Inseam: 70cm

Insulation:

Water column:

Weight:

Fabric:
Face: 100% Polyester / Back: 100% Polyurethane

Features:

- YKK® zippers
- Raglan sleeve for freedom of movement
- Helly Hansen® silicone print at sleeve

Colours:
222 Alert Red
482 Beluga
597 Navy



222



482

597

34044 HP OCEAN FZ HOODIE

USD \$130

Sizes: S-2XL

Fitting: Regular

CB/Inseam: 70cm

Insulation:

Water column:

Weight:

Fabric: 100% Polyester

Features:

- Double side Jersey spacer knit
- Lined hood
- YKK® front zip
- YKK® zippers in pockets
- laminated detail at pockets
- Raglan sleeve for freedom of movement
- Hydropower Design Capsule details
- Helly Hansen® silicone print at sleeve

Colours:
949 Grey Melange
990 Black



949



990

54213 HP 1/2 ZIP PULLOVER

USD \$65

Sizes: S-2XL
Fitting: Fitted
CB/Inseam: 72cm

Insulation:
Water column:
Weight:

Fabric:
 94% Polyamide,
 6% Elastane

Colours:
 222 Alert Red
 380 Antique Moss
 421 Lav Green
 599 Navy
 854 Grey Fog
 982 Ebony

Features:

- X-Cool quick dry fabric
- Technical double knit polyester jersey
- High collar with YKK® zipper
- No side seam for extra comfort
- Raglan sleeve for freedom of movement
- Contrast piping at neck zip
- Multiple marine inspired printed graphics



380



982



222



421



599



854

34123 HP SHORE LS POLO

USD \$80

Sizes: 3XS-6XL
Fitting: Regular
CB/Inseam:

Insulation:
Water column:
Weight:

Fabric:
 54% Cotton, 46%
 Polyester

Colours:
 458 Uniform Green
 597 Navy
 980 Ebony

Features:

- Quick Dry Cotton Polyester waffle pique
- Buttoned front placket
- Jacquard two tone Rib collar
- Side split
- printed HH logo on chest
- graphic element on sleeve
- UPF rating 30+



458



597



980

33997 SKAGEN MERINO SWEATER

USD \$120

Sizes: M-XL
Fitting: Regular
CB/Inseam: 70cm

Insulation:
Water column:
Weight:

Fabric:
 100% Merino Wool

Colours:
 216 Oxblood
 488 Scarab Green
 598 Navy
 778 Kodiak Brown
 950 Grey Melange
 981 Ebony Melange

Features:

- Fine Merino
- V-Neck
- Bottom Rib
- HH logo label
- Regular fit



216



981



488



598



778



950

34046 SKAGEN QUICKDRY RUGGER

USD \$75

Sizes: S-2XL
Fitting: Regular
CB/Inseam: 78cm

Insulation:
Water column:
Weight:

Fabric:
 74% cotton
 19% polyamide
 7%elastan

217 Spice
 482 Beluga
 598 Navy
 949 Grey Melange

Features:

- X-Cool quick dry fabric
- Technical double knit jersey
- Rib collar
- Graphic at sleeve



598



482



217



949



34125 SKAGEN LONG SLEEVE

USD \$55

Sizes: 3XS-6XL
Fitting: Regular
CB/Inseam: 69cm
Insulation:
Water column:
Weight:

Fabric:
100% Cotton

Colours:
488 Scarab Green
597 Navy
949 Grey Melange

- Features:**
- cotton waffle knit
 - long sleeves
 - rib at neck
 - chest pocket
 - HH logo



488



597

949

34124 FJORD LONG SLEEVE

USD \$40

Sizes: XS-2XL
Fitting: Regular
CB/Inseam: 69cm
Insulation:
Weight:

Fabric:
95% Cotton/5% Elastane

Colours:
458 Uniform Green
598 Navy
981 Ebony Melange

- Features:**
- Cotton jersey
 - long sleeves
 - regular fit
 - chest pocket
 - HH logo



458



598

981

34004 CREW POLO

USD \$55

Sizes: S-2XL
Fitting: Regular
CB/Inseam: 72cm
Water column:
Weight:

Fabric:
70% Cotton, 30% Polyester

Colours:
001 White
597 Navy

- Features:**
- Cotton pique
 - Buttoned front placket
 - Rib collar and cuffs
 - Embroidered HH® logo on sleeve

◇ tactel



001



597

50982 RIFTLINE POLO

USD \$60

Sizes: S-2XL
Fitting: Relaxed
CB/Inseam: 75cm
Insulation:
Weight:

Fabric:
100% Polyester

Colours:
002 White
598 Navy
994 Black

- Features:**
- Quick Dry Tactel® waffle pique, 195gm²
 - Buttoned front placket
 - Rib collar and sleeve cuffs
 - Side split
 - Embroidered HH® logo on chest
 - UPF rating 50+

◇ tactel



002



598

994



33996 HH QD CARGO PANT

USD \$80

Sizes: 28,30,32,33,34,36,38,
Fitting: Regular
CB/Inseam: 85cm
Insulation:
Water column:
Weight:
Features:
 • Quick Dry Ripstop
 • Cargo pockets
 • Hand Pockets
 • Back pockets
 • Zip Fly
 • Snap and Hook Button
 • Belt Loops
 • HH® logo
 • Hanger loop
Fabric: 100% Polyamide
Colours: 597 Navy
 980 Ebony



597



980

54154 HH QD CARGO SHORTS 11

USD \$60

Sizes: 28,30,32,33,34,36,38,
Fitting: Regular
CB/Inseam: 28cm
Insulation:
Water column:
Weight:
Features:
 • Durable quick-dry stretch rip stop polyamide
 • Zip fly with single flat button waist closure for minimum bulk
 • Mesh-lined pockets
 • Slant hip pockets
 • Two cargo pockets with hidden snap closure
 • Secure back pocket with YKK® zip closure
 • Gusset crotch for freedom of movement
 • Belt loops
 • Printed HH® logo on thigh pocket flap
 • UPF 40+
Fabric: 92% Polyamide, 8% Elastane
Colours: 458 Uniform Green
 597 Navy
 720 Fallen Rock
 980 Ebony

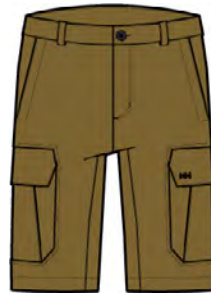

458



597



720



980

34163 HH LOGO FULL ZIP HOODIE

USD \$75

Sizes: S-2XL
Fitting: Regular
CB/Inseam: 72cm
Insulation:
Water column:
Weight:
Features:
 • Soft Cotton French terry
 • Full YKK® zip in front
 • Helly Hansen® logo artwork on left chest
 • Jersey lined hood
 • Hand pockets
 • Cotton drawstring at hood
 • Ribbed hem and sleeve cuffs
Fabric: Face: 100% Polyamide / Back: 100% Polyurethane
Colours: 597 Navy
 949 Grey Melange



597



949

33977 HH LOGO HOODIE

USD \$70

Sizes: S-2XL
Fitting: Regular
CB/Inseam: 72cm
Insulation:
Water column:
Weight:
Features:
 • Soft Cotton French terry
 • Helly Hansen® logo artwork across chest
 • Jersey lined hood
 • Kangaroo pocket
 • Cotton drawstring at hood
 • Ribbed hem and sleeve cuffs
Fabric: Face: 100% Polyamide / Back: 100% Polyurethane
Colours: 222 Alert Red
 421 Lav Green
 597 Navy
 981 Ebony Melange



222



421



597



981

MEN'S WATERSPORT

33979 HH LOGO T-SHIRT

USD \$30

Sizes: S-2XL
Fitting: Regular
CB/Inseam: 72cm

Insulation:
Water column:
Weight:

Fabric: 100% Cotton

Features:

- Classic fit T-shirt
- Cotton single jersey
- Helly Hansen® logo artwork across chest

Colours:
 001 White
 222 Alert Red
 458 Uniform Green Melange
 597 Navy
 793 Redwood Melange
 982 Ebony Melange



001



982



222



458



597



793

34000 HH LOGO CREW SWEAT

USD \$65

Sizes: S-2XL
Fitting: Regular
CB/Inseam: 71cm

Insulation:
Water column:
Weight:

Fabric: 100% Polyamide

Features:

- French Terry Cotton
- HH® logo Print
- Crew Neck Sweater
- Bottom hem and sleeve rib

Colours:
 222 Alert Red
 458 Uniform Green Melange
 597 Navy
 950 Grey Melange
 982 Ebony Melange



458



222



597



950



982



B2B STYLES

30253 CREW MIDLAYER JACKET

USD \$165

Sizes:
S-5XL
Fabric:
100% Polyamide
Fitting:
Regular

Colours:
990 Black
597 Navy
001 White



30317 W CREW MIDLAYER JACKET

USD \$165

Sizes:
XS-4XL
Fabric:
100% Polyester

Colours:
992 Black
598 Navy
002 White



30270 CREW VEST

USD \$125

Sizes:
S-2XL
Fabric:
100% Polyester
Fitting:
Regular

Colours:
990 Black
597 Navy
001 White



30317 W CREW MIDLAYER JACKET

USD \$125

Sizes:
XS-XL
Fabric:
100% Polyester

Colours:
597 Navy
001 White



62643 DUBLINER JACKET

USD \$130

Sizes:
XS-5XL
Fabric:
100% Polyester
Fitting:
Regular

Colours:
990 Black
597 Navy



62650 W ADEN JACKET

USD \$130

Sizes:
S-4XL
Fabric:
100% Polyester

Colours:
990 Black



62047 SEVEN J JACKET

USD \$100

Sizes:
S-5XL
Fabric:
100% Polyester
Fitting:
Regular

Colours:
992 Black
596 Navy



62066 W SEVEN J JACKET

USD \$100

Sizes:
XS-4XL
Fabric:
100% Polyester

Colours:
992 Black
597 Navy



62252 LOKE JACKET

USD \$100

Sizes: S-5XL
Colours: 990 Black
Fabric: 100% Polyamide
Fitting: Regular



990

62282 W LOKE JACKET

USD \$100

Sizes: XS-4XL
Colours: 992 Black
Fabric: 100% Polyamide



002

62915 PARAMOUNT SOFTSHELL JACKET

USD \$130

Sizes: S-5XL
Colours: 990 Black
Fabric: 100% Polyester
Fitting: Regular



990

62925 W PARAMOUNT JACKET

USD \$130

Sizes: XS-4XL
Colours: 990 Black
Fabric: 100% Polyester



990

62916 PARAMOUNT VEST

USD \$110

Sizes: S-5XL
Colours: 990 Black
Fabric: 100% Polyester
Fitting: Regular



990

62925 W PARAMOUNT JACKET

USD \$110

Sizes: S-3XL
Colours: 990 Black
Fabric: 100% Polyester



990

62916 PARAMOUNT VEST

USD \$110

Sizes: S-5XL
Colours: 990 Black
Fabric: 100% Polyester
Fitting: Regular



990

62925 W PARAMOUNT JACKET

USD \$110

Sizes: S-3XL
Colours: 990 Black
Fabric: 100% Polyester



990



51598 DAYBREAKER FLEECE JACKET USD \$65

Sizes:
S-5XL
Fabric:
100% Polyamide
Fitting:
Regular

Colours:
990 Black
598 Navy



51599 W DAYBREAKER FLEECE JACKET USD \$65

Sizes:
XS-4XL
Fabric:
100% Polyester

Colours:
991 Black
599 Navy



50844 DAYBREAKER 1/2 ZIP USD \$55

Sizes:
XS-5XL
Fabric:
100% Polyester
Fitting:
Regular

Colours:
990 Black
599 Navy



50845 W DAYBREAKER 1/2 ZIP USD \$55

Sizes:
XS-4XL
Fabric:
100% Polyester

Colours:
599 Navy
990 Black



50982 RIFTLINE POLO USD \$60

Sizes:
S-4XL
Fabric:
100% Polyester
Fitting:
Regular

Colours:
002 White
598 Navy



33984 W TECH CREW POLO USD \$60

Sizes:
XS-3XL
Fabric:
94% Polymide,
6% Elastane

Colours:
990 Black
001 White
597 Navy



34004 CREW POLO USD \$45

Sizes:
S-4XL
Fabric:
100% Cotton
Fitting:
Regular

Colours:
001 Black
597 Navy



53055 W CREW PIQUE 2 POLO USD \$45

Sizes:
S-3XL
Fabric:
100% Polyester

Colours:
001 White
597 Navy



48365 HH TECH CREW ½ ZIP

USD \$40

Sizes:
XS-4XL
Fabric:
100% Polyaeater
Fitting:
Regular

Colours:
930 Light Grey
563 Olympian Blue
001 White



48364 HH TECH CREW

USD \$30

Sizes:
XS-4XL
Fabric:
100% Polyaeater

Colours:
563 Olympian Blue
001 White
930 Light Grey



48363 HH TECH TEE

USD \$40

Sizes:
XS-4XL
Fabric:
100% polyester -
145 g/m²
Helly Tech®
Protection
Fitting:
Regular

Colours:
930 Light Grey
563 Olympian Blue
001 White



48374 W HH TECH CREW

USD \$30

Sizes:
XS-XL
Fabric:
100% Polyester

Colours:
563 Olympian Blue
001 White
930 Light Grey



67386 DUBLIN 2.0 BACKPACK

USD \$55

Sizes:
STD
Colours:
990 Black



67160 CREW CAP

USD \$20

Sizes:
STD
Colours:
597 Navy



57502 BRAND BEANIE

USD \$22

Sizes:
STD
Colours:
990 Black





WOMEN'S



WOMEN'S WINTERSPORT

65721 W SAPPORO FRINGE STRETCH JACKET

USD \$1,100



Sizes: XS-XL
Fitting: Fitted
CB/Inseam:

Insulation: Water column: Weight:

Fabric:
Shell: 100% Polyester
Lining: 100% Polyester
Shell 2: 100% Polyamide

Colours:
047 Snow
990 Black

- Features:**
- HELLY TECH® Performance
 - 2-layer construction
 - 4-way stretch fabric
 - Luxury velvet lining
 - Consciously chosen leather imitation
 - Life pocket+™ with AeroGel Insulation
 - Primaloft® Gold Insulation
 - Body: 80g Sleeves: 80g Hood: Down blend
 - Fully seam sealed
 - Waterproof, windproof and breathable
 - Durable Water Repellency (DWR) treatment



047



990

HOD
The Hod Collection is inspired by HOD, the Norse God of Winter and our love for skiing. It is experimental with trend right silhouettes, fabrics and new inspirational themes each year. This season is inspired by the 1970's, when innovative fabrics and styles revolutionized skiwear. With bright colors, high-waisted flared pants, faux leather fringes and upgrading with our modern technologies like H2Flow™, Lifa®, Lifepocket™ and LifaLoft™.

65723 W BANCO PUFFY JACKET

USD \$1,000



Sizes: XS-XL
Fitting: Regular
CB/Inseam:

Insulation: Water column: Weight:

Fabric:
100% Polyamide

Colours:
001 Nmm Hh Logo
White
285 Saffron Camo

- Features:**
- Waterproof, windproof and breathable
 - Lightweight 2-layer construction with welded down channels
 - All over foil print
 - Life pocket+™ with AeroGel Insulation
 - Allied® down 600 FP insulation
 - Durable Water Repellency (DWR) treatment
 - RECCO® Advanced Rescue system
 - Articulated sleeves for optimal mobility
 - Detachable powder skirt
 - Helmet compatible hood



001



285

65722 W ROSI INSULATED SOFTSHELL JACKET

USD \$800



Sizes: XS-XL
Fitting: Fitted
CB/Inseam:

Insulation: Water column: Weight:

Fabric:
74% Polyamide,
26% Elastane

Colours:
597 Navy
990 Black

- Features:**
- HELLY TECH® Performance
 - 3L knitted stretch softshell
 - 4-way stretch fabric
 - Embossed lining in body and velvet lining in collar
 - Life pocket+™ with AeroGel Insulation
 - Primaloft® Gold Insulation
 - Body: 80g Sleeves: 80g Hood: Down blend
 - Fully seam sealed
 - Waterproof, windproof and breathable
 - Durable Water Repellency (DWR) treatment
 - Mechanical ventilation zippers



597



990

65724 W TRICOLORE INSULATED JACKET

USD \$700



Sizes: XS-XL
Fitting: Regular
CB/Inseam:

Insulation: Water column: Weight:
12500/24400

Fabric:
70% Polyamide,
30% Polyester

Colours:
433 Fresh Green
639 Electric Blue
857 Pelican

- Features:**
- HELLY TECH® Performance
 - Mélange ripstop fabric
 - Embossed lining in body and velvet lining in collar
 - Life pocket+™ with AeroGel Insulation
 - Primaloft® Down blend Insulation
 - Fully seam sealed
 - Waterproof, windproof and breathable
 - Durable Water Repellency (DWR) treatment
 - Mechanical ventilation zippers
 - RECCO® Advanced Rescue system
 - Articulated sleeves for optimal mobility



433



639



857

WOMEN'S WINTERSPORT



65755 W LIFALOFT SUIT

USD \$350



Sizes: XS-XL
Fitting: Regular
CB/Inseam:
Insulation: **Water column:** **Weight:**

lifaloft

Fabric:
 Shell: 91% Polyamide, 9% Elastane - : 50% Polyamide, 41% Polyester, 9% Elastane
 - Insulation body: 70% Polypropylene, 30% Polyester

Colours:
 597 Navy

- Features:**
- LIFALOFT™ insulation by Primaloft®
 - Water resistant and windproof fabric
 - Fiber and down proof fabric construction
 - PFC free Durable Water Repellency (DWR) treatment
 - LIFALOFT™ insulation by Primaloft®
 - Full length center front zipper
 - Elastic waist band
 - Elastic striped wrist, ankle and neck cuff
 - Full inner front zipper placket for wind protection
 - HH® LIFALOFT™ logo at front left chest



597

65727 W TRICOLORE QUILTED INSULATOR JACKET USD \$300



Sizes: XS-XL
Fitting: Fitted
CB/Inseam:
Insulation: **Water column:** **Weight:**



YKK

Fabric:
 100% Polyester

Colours:
 047 Snow
 639 Electric Blue

- Features:**
- Primaloft® Gold insulation 80g
 - 30 denier windproof and water resistant fabric
 - PFC free DWR
 - Stretch lining for added comfort
 - Elastic striped rib at bottom hem and sleeve and collar
 - Two hand warming pockets
 - YKK® Auto lock center front zipper with customized zipper puller



047



639

65728 W TRICOLORE KNITTED SWEATER

USD \$200



Sizes: XS-XL
Fitting: Fitted
CB/Inseam:
Insulation:
Water column:
Weight:

Fabric:
 Shell: 65% Wool,
 35% Polyamide

Colours:
 001 White
 034 Cream
 285 Saffron

Features:

- Premium Merino wool yarn
- Plain knit construction in body
- Ottoman elbow rib for added movement
- 1x1 rib at bottom hem and sleeve and collar
- Felt badge on arm
- 1/2 zip with customized zipper puller



001



034



285

49372 W HOD LIFA MERINO LIGHTWEIGHT 1/2 ZIP

USD \$130

Sizes: XS-XL
Fitting: Regular
CB/Inseam: 64cm
Insulation:
Water column:
Weight: 160G/M2

Fabric:
 70% Merino Wool,
 30% Polypropylene

Colours:
 011 Off White
 441 Marka Green
 597 Navy

Features:

- 2-layer construction
- 1/2 zip construction
- 100% Merino Wool exterior
- 160g LIFA® Merino fabric
- Non-itch
- Flat lock seams

lifa



YKK



011



441



597

65725 W ROSI BIB SOFTSHELL PANT

USD \$550



Sizes: XS-XL
Fitting: Fitted
CB/Inseam:
Insulation:
Water column:
Weight:

Fabric:
 Shell: 74%
 Polyamide, 26%
 Elastane - Lining:
 100% Polyester

Colours:
 047 Snow
 597 Navy

Features:

- Waterproof, windproof and breathable
- 3L knitted stretch softshell
- 4-way stretch fabric
- Brushed inside for extra warmth
- Bib construction with striped elastic suspenders
- RECCO® Advanced Rescue system
- SKI FREE
- Extra long bottom hem zippers to accommodate battery pack for insole
- Durable Water Repellency (DWR) treatment
- Striped webbing on the side of the pant

YKK

RECCO



047



597

65726 W SAPPORO STRETCH HIGHWAIST PANT

USD \$450



Sizes: XS-XL
Fitting: Fitted
CB/Inseam:
Insulation:
Water column:
Weight:

Fabric:
 Shell: 100%
 Polyamide - Lining:
 100% Polyester
 - Insulation: 55%
 Recycled Polyester,
 45% Polyester

Colours:
 047 Snow
 226 Bright Orange
 990 Black

Features:

- Waterproof, windproof and breathable
- 3L knitted stretch softshell
- 4-way stretch fabric
- Embossed soft lining
- Adjustable waist
- RECCO® Advanced Rescue system
- SKI FREE
- Extra long bottom hem zippers to accommodate battery pack for insole
- Durable Water Repellency (DWR) treatment
- Boot gaiters with stretch silicone gripper
- Bemis Reinforcement fabric on bottom

YKK

RECCO



047



226



990



65729 W BANCO PUFFY PANT

USD \$400

Sizes: XS-XL
Fitting: Regular
CB/Inseam:

Insulation: **Water column:** **Weight:**

- Fabric:**
 Shell: 100% Polyamide - Shell
 2: 100% Polyamide - Lining: 100% Polyester - Lining
 2: 100% Polyester - Insulation: 80% Duck Down, 20% Duck Feather
- Colours:**
 001 Nmm Hh Logo White
 047 Snow
- Features:**
- Waterproof, windproof and breathable
 - Lightweight 2-layer construction with welded down channels
 - All over foil print
 - Bemis Reinforcement fabric on bottom hem
 - Allied® down 600 FP insulation
 - Adjustable waist
 - Durable Water Repellency (DWR) treatment
 - Dual hand warming
 - RECCO® Advanced Rescue system
 - Bottom hem zippers



001



047

65730 W SNOW BOOT GAITORS

USD \$90

Sizes: STD
Fitting: **CB/Inseam:**

Insulation: **Water column:** **Weight:**

- Fabric:**
 Shell: 70% Polyamide, 30% Polyester - : 70% Polyamide, 30% Polyester - : 70% Polyamide, 30% Polyester - Lining: 100% Polyamide
- Colours:**
 226 Bright Orange
- Features:**
- Full length zipper with customized puller
 - Waterproof, windproof and breathable
 - 2-layer construction
 - Elastic striped webbing
 - Silicone gripper at bottom hem
 - Felt logo

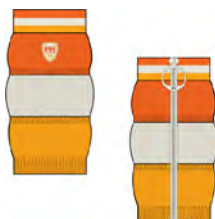

226

65731 W PINNACLE JACKET

USD \$700

Sizes: XS-XL
Fitting: Fitted
CB/Inseam:

Insulation: **Water column:** **Weight:**

- Fabric:**
 Shell: 85% Polyamide, 15% Elastane
- Colours:**
 001 White
 222 Alert Red
 990 Black
- Features:**
- HELLY TECH® Professional fabric
 - 2-layer fabric construction
 - 4-way stretch fabric
 - H2Flow™ Air Force Vent System: Mechanical venting for optimal comfort
 - Life pocket+™ with Aerogel® Insulation
 - SKI FREE
 - Fully seam sealed
 - Waterproof, windproof and breathable
 - Durable Water Repellency (DWR) treatment
 - Primaloft® Black Eco Insulation
 - Body: 100g Sleeves:100g Hood:100g



001



222



990

RESORT

A sharp classic ski design integrated into performance ski apparel with proven technologies and innovations to give confidence every day on the mountain.

65732 W AVANTI JACKET

USD \$550

Sizes: XS-XL
Fitting: Fitted
CB/Inseam:

Insulation: **Water column:** **Weight:**

- Fabric:**
 Shell: 85% Polyamide, 15% Elastane
- Colours:**
 001 White
 597 Navy
 990 Black
- Features:**
- Lightweight down channels on chest
 - 2-layer fabric construction
 - 4-way stretch fabric
 - H2Flow™ Technology
 - Life pocket+™ with Aerogel® Insulation
 - SKI FREE
 - Strategic seam sealed
 - Waterproof, windproof and breathable
 - Durable Water Repellency (DWR) treatment
 - Primaloft® Black Eco Insulation
 - Body: Down blend Sleeves:100g Hood:100g



001



597



990

WOMEN'S WINTERSPORT

65676 W ALPHELIA LIFALOFT JACKET

USD \$475

Sizes: XS-XL
Fitting: Fitted
CB/Inseam: 66 cm

Insulation: LIFALOFT™ 80g insulation
Water column: 20000
Weight:

Fabric:
 Face: 89% Polyamide, 11% Elastane / Back: 100% Polyurethane

Colours:
 002 White
 223 Alert Red
 525 Turquoise
 599 Navy
 662 Wild Rose

Features:

- HELLY TECH® Professional fabric
- 2-layer fabric construction
- 4-way stretch fabric
- Fully insulated with LIFALOFT™ insulation
- Life pocket™ with AeroGel® Insulation
- Laser cut exterior air ports at back yoke
- Fully seam sealed
- Waterproof, windproof and breathable
- Durable Water Repellency (DWR) treatment
- RECCO® Advanced Rescue system
- Slick and slide shoulder panels for added comfort



65677 W MOTIONISTA LIFALOFT JACKET

USD \$375

Sizes: XS-XL
Fitting: Regular
CB/Inseam: 72 cm

Insulation: LIFALOFT™ 80g insulation
Water column: 20000
Weight:

Fabric:
 Face: 100% Polyester / Back: 100% Thermoplastic Polyurethane

Colours:
 002 White
 003 White
 525 Turquoise
 662 Wild Rose
 990 Black

Features:

- HELLY TECH® Professional fabric
- 2-layer fabric construction
- 4-way stretch fabric
- Fully insulated with LIFALOFT™ insulation
- Life pocket™ with Primaloft® Insulation
- Fully insulated
- Soft stretch lining
- Fully seam sealed
- Durable Water Repellency (DWR) treatment
- Waterproof, windproof and breathable
- RECCO® Advanced Rescue system
- Articulated sleeves for optimal mobility



65690 W IMPERIAL PUFFY JACKET

USD \$350

Sizes: XS-XL
Fitting: Regular
CB/Inseam: 71 cm

Insulation: 25000/27700
Water column: 25000/27700
Weight:

Fabric:
 Face: 100% Polyester / Back: 100% Polyurethane

Colours:
 002 White
 003 White
 525 Turquoise
 990 Black

Features:

- Waterproof, windproof and breathable
- 2-layer fabric construction
- Structured fabric
- Synthetic down insulation
- Life pocket™ with Primaloft® Insulation
- Fully insulated
- Durable Water Repellency (DWR) treatment
- RECCO® Advanced Rescue system
- Articulated sleeves for optimal mobility
- Detachable powder skirt
- Helmet compatible hood

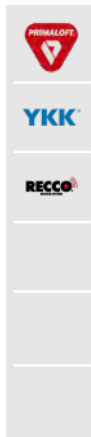

65678 W MAJESTIC WARM JACKET

USD \$300

Sizes: XS-XL
Fitting: Regular
CB/Inseam: 72 cm

Insulation: 10000
Water column: 10000
Weight:

Fabric:
 Face: 100% Polyester / Back: 100% Polyurethane

Colours:
 002 White
 255 Liberty
 598 Navy
 991 Black

Features:

- HELLY TECH® Performance
- 2-layer fabric construction
- Mechanical 2-way stretch fabric
- Soft fur inside CB panel for warmth and comfort
- Life pocket™
- Under arm ventilation
- Fully seam sealed
- Waterproof, windproof and breathable
- Durable Water Repellency (DWR) treatment
- Primaloft® Black Eco Insulation 133g
- Articulated sleeves for optimal mobility



65733 W VALDISERE PUFFY JACKET

USD \$350

Sizes: XS-XL
Fitting: Regular
CB/Inseam:

Insulation:
Water column: 32800/17600
Weight:

Fabric:
Shell: 100% Polyester - Lining: 100% Polyester
- Insulation: 60% Duck Down, 40% Duck Feather - Insulation: 80% Recycled Polyester, 20% Polyester

Colours:
597 Navy
857 Pelican
990 Black

Features:

- 2-layer construction
- Leopard jacquard fabric
- Life pocket™
- Allied® Down 480 FP in body
- Primaloft® Black Eco 100g in hood
- Waterproof, windproof and breathable
- Durable Water Repellency (DWR) treatment
- Fully insulated
- Articulated sleeves for optimal mobility
- Detachable powder skirt
- Helmet compatible hood with faux fur as lining



597



857



990

65734 W BLUEBIRD JACKET

USD \$325

Sizes: XS-XL
Fitting: Regular
CB/Inseam:

Insulation:
Water column: 36000
Weight:

Fabric:
Shell: 100% Polyester - Shell 2: 100% Polyester
- Shell 2: 85% Polyester, 15% Polyamide - Lining: 100% Polyamide
- Insulation: 100% Polyester

Colours:
857 Pelican
980 Ebony
983 Slate

Features:

- HELLY TECH® Performance
- 2-layer construction
- Mélange main fabric
- Fully insulated with synthetic down
- Waterproof, windproof and breathable
- Durable Water Repellency (DWR) treatment
- Fully seam sealed
- Articulated sleeves for optimal mobility
- Detachable powder skirt
- Helmet compatible hood with down channels
- Dual bellow pockets and 2 hand warming pockets



857



980



983

65630 W ALPHELIA PANT

USD \$300

Sizes: XS-XL
Fitting: Fitted
CB/Inseam: 79cm

Insulation:
Water column: 10000
Weight:

Fabric:
Face: 85% Polyamide, 15% Elastane / Back: 100% Polyurethane

Colours:
001 White
255 Liberty
525 Turquoise
990 Black

Features:

- HELLY TECH® Professional fabric
- 2-layer fabric construction
- 4-way stretch fabric
- SKI FREE
- Inner thigh ventilation zippers
- Fully seam sealed
- Waterproof, windproof and breathable
- Durable Water Repellency (DWR) treatment
- Fully insulated
- RECCO® Advanced Rescue system
- Boot gaiters with stretch silicone gripper
- Reinforcement fabric on bottom hem



001



255



525



990

65737 W AVANTI STRETCH PANT

USD \$280

Sizes: XS-XL
Fitting: Fitted
CB/Inseam:

Insulation:
Water column:
Weight:

Fabric:
Shell: 74% Polyamide, 26% Elastane - Lining: 86% Polyester, 14% Elastane

Colours:
047 Snow
597 Navy
990 Black

Features:

- Waterproof, windproof and breathable
- 3L knitted stretch softshell
- 4-way stretch fabric
- Brushed inside for extra warmth
- High waist for extra protection
- SKI FREE
- Extra long bottom hem zippers to accommodate battery pack for insole
- Fully seam sealed
- Durable Water Repellency (DWR) treatment
- Boot gaiters with stretch silicone gripper



047



597



990



WOMEN'S WINTERSPORT

65736 W BELLISSIMO 2 PANT

USD \$200

Sizes: XS-XL
Fitting: Fitted
CB/Inseam:

Insulation:
Water column: 16000/ 18000
Weight:

Fabric:
Shell: 87% Polyamide, 13% Elastane - Lining: 86% Polyester, 14% Elastane

Colours:
001 White
597 Navy
990 Black

- Features:**
- Wind and waterproof softshell
 - 3-layer fabric construction
 - Soft stretch fabric
 - Durable Water Repellency (DWR) treatment
 - Brushed inside for extra warmth
 - Articulated knees for optimal mobility
 - Boot gaiters with silicone gripper
 - Dual hand pockets and back pocket
 - Bottom hem zippers
 - Belt loops
 - YKK® zippers



001



597



990

65683 W LEGENDARY INSULATED PANT

USD \$200

Sizes: XS-2XL
Fitting: Regular
CB/Inseam: 80cm

Insulation:
Water column: 10000
Weight:

Fabric:
Face: 100% Polyester / Back: 100% Polyurethane

Colours:
001 White
223 Alert Red
255 Liberty
525 Turquoise
597 Navy
857 Pelican
990 Black

- Features:**
- HELLY TECH® Performance
 - Waterproof, windproof and breathable
 - 2-layer fabric construction
 - 2-way stretch fabric
 - Fully seam sealed
 - Primaloft® Black Insulation 60g
 - Fully insulated
 - Durable Water Repellency (DWR) treatment
 - Inner thigh ventilation zippers



001



597



857



990



223



255



525

65753 W POWDERQUEEN 3.0 JACKET

USD \$450

Sizes: XS-XL
Fitting: Relaxed
CB/Inseam:

Insulation:
Water column: 36000
Weight:

Fabric:
70% Polyamide, 30% Polyester

Colours:
096 Ash Rose
458 Uniform Green
525 Turquoise

- Features:**
- HELLY TECH® Professional fabric
 - 2-layer construction
 - Mélange Ripstop fabric
 - Life pocket+™ with Aerogel Insulation
 - Hi vis hood brim
 - Fully seam sealed
 - Primaloft® Black Eco Insulation 60g in body, 40g in sleeves and hood
 - Waterproof, windproof and breathable
 - Durable Water Repellency (DWR) treatment
 - Under arm side ventilation zippers
 - RECCO® Advanced Rescue system
 - Articulated sleeves for optimal mobility



HELLY TECH® Professional fabric

Recco® Advanced Rescue system

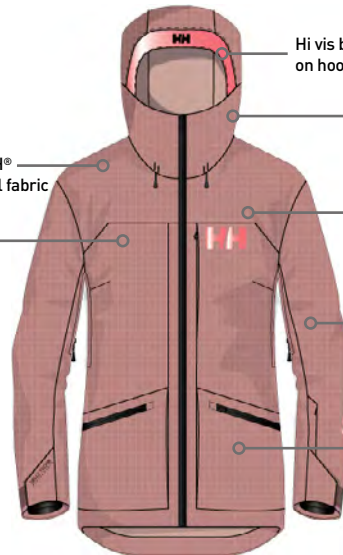

096

Hi vis brim on hood

Helmet compatible hood

Mélange ripstop fabric

Articulated sleeves for optimal mobility

Primaloft® Black eco insulation



525



458

ULLR

Our freeride collection is developed and tested in collaboration with our Helly Hansen free skiing professionals around the world.

65634 W AURORA SHELL 2.0 JACKET

USD \$550



Sizes: XS-XL
Fitting: Relaxed
CB/Inseam: 77cm

Insulation: 20000
Water column: 20000
Weight:

Fabric:
Face: 100% Polyester / Back: 100% Polyurethane

Colours:
096 Ash Rose
458 Uniform Green

- Features:**
- 3-layer fabric construction shell jacket
 - Reinforcement print on shoulders
 - Life Pocket™ with Aerogel Insulation
 - SKI FREE
 - Hi vis hood brim
 - Fully seam sealed
 - Waterproof, windproof and breathable
 - Durable Water Repellency (DWR) treatment
 - Under arm side ventilation zippers
 - Zipped expansion fan at front collar for extra comfort
 - RECCO® Advanced Rescue system

YKK

RECCO



096



458

65684 W WHITEWALL LIFALOFT JACKET

USD \$400



Sizes: XS-XL
Fitting: Relaxed
CB/Inseam: 82cm

Insulation: LIFALOFT™ 80g insulation
Water column: 20000
Weight:

Fabric:
Face: 100% Polyamide / Back: 100% Polyurethane

Colours:
096 Ash Rose
857 Pelican
983 Slate

- Features:**
- HELLY TECH® Professional fabric
 - 2-layer fabric construction
 - Fully insulated with 80g LIFALOFT™™ Insulation and brushed stretch panels for added breathability
 - Life pocket™
 - Hi vis hood brim
 - Fully seam sealed
 - Waterproof, windproof and breathable
 - Durable Water Repellency (DWR) treatment
 - Under arm ventilation zippers

HELLY TECH® PROFESSIONAL

YKK

RECCO



096



857



983

65701 W POWCHASER LIFALOFT JACKET

USD \$350



Sizes: XS-XL
Fitting: Relaxed
CB/Inseam: 78,5cm

Insulation: LIFALOFT™ 80g insulation
Water column: 10000
Weight:

Fabric:
Face: 100% Polyester / Back: 100% Thermoplastic Polyurethane

Colours:
047 Snow Nmm Map Print
458 Uniform Green
662 Wild Rose
983 Slate

- Features:**
- HELLY TECH® Professional fabric
 - 2-layer fabric construction
 - Fully insulated with 80g LIFALOFT™™ Insulation and brushed stretch panels for added breathability
 - Life pocket™
 - Hi vis hood brim
 - Fully seam sealed
 - Waterproof, windproof and breathable
 - Durable Water Repellency (DWR) treatment
 - Under arm ventilation zippers

HELLY TECH® PROFESSIONAL

YKK

RECCO



047



458



662



983

65638 W AURORA SHELL 2.0 PANT

USD \$350



Sizes: XS-XL
Fitting: Relaxed
CB/Inseam: 84cm

Insulation: 20000
Water column: 20000
Weight:

Fabric:
Face: 100% Polyester / Back: 100% Polyurethane

Colours:
458 Uniform Green
983 Slate

- Features:**
- 3ply stretch fabric construction
 - SKI FREE
 - Reinforcement on bottom leg
 - Fully seam sealed
 - Waterproof, windproof and breathable
 - Durable Water Repellency (DWR) treatment
 - Outer thigh ventilation zippers RECCO® Advanced Rescue system
 - Articulated construction at seat and knee for superior fit
 - Attached stretch snow gaiters
 - Adjustable waist with fastener

YKK

RECCO



458



983



65643 W POWDERQUEEN BIB PANT

USD \$300



Sizes: XS-XL
Fitting: Regular
CB/Inseam: 81cm

Insulation: Water column: 20000
Weight:

Fabric:
 Face: 100% Polyester / Back: 100% Polyurethane

Colours:
 857 Pelican
 983 Slate

Features:

- 2-layer fabric construction
- SKI FREE
- Reinforcement fabric on bottom leg
- Fully seam sealed
- Waterproof, windproof and breathable
- Durable Water Repellency (DWR) treatment
- Comfortable bib construction with big bellow pocket on front chest
- Adjustable elastic suspenders
- Belt loops compatible with jacket powder skirt attachment.



857



983

65754 W SWITCH CARGO INSULATED PANT

USD \$225



Sizes: XS-XL
Fitting: Relaxed
CB/Inseam:

Insulation: Water column:
Weight:

Fabric:
 Shell: 100% Polyester

Colours:
 047 Snow Nmm - Map
 096 Ash Rose
 247 Neon Coral
 458 Uniform Green
 525 Turquoise
 857 Pelican
 983 Slate

Features:

- HELLY TECH® Protection
- Waterproof, windproof and breathable
- 2-ply ripstop fabric
- 2-way stretch fabric
- Fully seam sealed
- Primaloft® Black Eco Insulation 40g, seat and knee
- Durable Water Repellency (DWR) treatment
- Inner thigh ventilation zippers
- Articulated knees for optimal mobility
- Boot gaiters with silicone gripper
- Reinforcement on bottom leg



047



857



983



096



247



458



525

65756 W LIFALOFT TOASTY COAT

USD \$300

LIFALOFT™

Lightweight warmth for all seasons. 20% lighter and still warmer than standard insulation.

Sizes: XS-XL
Fitting: Relaxed
CB/Inseam:

Insulation: Water column:
Weight:

Fabric:
 Shell: 100% Polyamide - Lining: 100% Polyamide - Insulation: 70% Polypropylene, 30% Polyester

Colours:
 458 Uniform Green
 793 Redwood
 990 Black

Features:

- Fiber and down proof fabric construction
- PFC Free DWR
- Long tailored coat design
- LIFALOFT™ insulation by Primaloft®
- YKK® Center front zipper and hand warmer pockets
- Full inner front zipper placket for wind protection
- HH Lifaft™ logo at front left chest



458



793



990

65624 W LIFALOFT INSULATOR COAT

USD \$250

Sizes: XS-XL
Fitting: Regular
CB/Inseam: 90cm

Insulation: Water column:
Weight:

Fabric:
 100% Polyamide

Colours:
 047 Snow
 458 Uniform Green
 990 Black

Features:

- Fiber and down proof fabric construction
- PFC Free DWR
- Oversized coat design
- LIFALOFT™ insulation by Primaloft®
- YKK® Center front zipper and dual YKK® zipped hand warmer pockets.
- Full inner front zipper placket for wind protection.
- Lycra edge band around hood and cuffs for clean finish
- HH Lifaft™ logo at front left chest.



047



458



990

65687 W LIFALOFT HOODED STRETCH INSULATOR JACKET USD \$280

Sizes: XS-XL
Fitting: Regular
CB/Inseam: 68.5 cm

Insulation: LIFALOFT™ 80g insulation

Fabric: 91% Polyamide, 9% Elastane

Colours: 065 Raspberry
 525 Turquoise
 640 Ice Blue
 990 Black

Water column:
Weight:

Features:

- LIFALOFT™ insulation by Primaloft®
- 4 way stretch fabric
- Fiber and down proof fabric construction
- Durable Water Repellency (DWR) treatment
- Life Pocket™
- Articulated sleeves for optimal mobility
- Full inner front zipper placket for wind protection
- Hand warming pockets
- Adjustable hem with drawcord
- Hood for under helmet
- HH@ LIFALOFT™ logo at front left chest

lifaloft



YKK



065



525



640



990

65626 W LIFALOFT HOODED INSULATOR JACKET USD \$220

Sizes: XS-XL
Fitting: Regular
CB/Inseam: 68,5 cm

Insulation: LIFALOFT™ 80g insulation

Fabric: 100% Polyamide

Colours: 047 Snow
 060 Misty Rose
 983 Slate
 991 Black Matte

Water column:
Weight:

Features:

- LIFALOFT™ insulation by Primaloft®
- Fiber and down proof fabric construction
- Durable Water Repellency (DWR) treatment
- Hand pockets with brushed lining
- YKK® zip closure
- Full inner front zipper placket for wind protection
- HH@ LIFALOFT™ logo at front left chest

lifaloft



YKK



047



060



983



991

65625 W LIFALOFT INSULATOR JACKET USD \$200

Sizes: XS-XL
Fitting: Regular
CB/Inseam: 68,5 cm

Insulation: LIFALOFT™ 80g insulation

Fabric: 100% Polyamide

Colours: 060 Misty Rose
 255 Liberty
 983 Slate
 990 Black

Water column:
Weight:

Features:

- LIFALOFT™ insulation by Primaloft®
- Fiber and down proof fabric construction
- Durable Water Repellency (DWR) treatment
- Hand pockets with brushed lining
- YKK® zip closure
- Full inner front zipper placket for wind protection
- HH@ LIFALOFT™ logo at front left chest

lifaloft



YKK



990



060



255



983

65627 W LIFALOFT HYBRID INSULATOR JACKET USD \$185

Sizes: XS-XL
Fitting: Regular
CB/Inseam: 66 cm

Insulation: LIFALOFT™ 80g insulation

Fabric: 100% Polyamide

Colours: 065 Raspberry
 640 Ice Blue
 983 Slate
 990 Black

Water column:
Weight:

Features:

- LIFALOFT™ insulation by Primaloft®
- Fiber and down proof fabric construction
- Durable Water Repellency (DWR) treatment
- Hybrid construction
- quilted LIFALOFT™ panels with knitted slick face fleece at lower sleeve, side panels and lower front and back
- Hand pockets with brushed lining
- YKK® zip closure
- Full inner front zipper placket for wind protection
- HH@ LIFALOFT™ logo at front left chest

lifaloft



YKK



983



065



640



990



WOMEN'S WINTERSPORT

65629 W LIFALOFT PROPILE VEST

USD \$175

Sizes:
XS-XL

Fitting:
Regular

CB/Inseam:
68,5 cm

Insulation:
LIFALOFT™ 80g
insulation

Water column: **Weight:**

Fabric:
100% Polyamide

Colours:
047 Snow
060 Misty Rose
983 Slate

Features:

- Reversible vest construction with pile and LifaLoft™ quilted panels.
- Fiber and down proof fabric construction
- PFC Free DWR
- LIFALOFT™ insulation by Primaloft®
- YKK® Center front zipper and dual YKK® zipped hand warmer pockets.
- Full inner front zipper placket for wind protection.
- Lycra edge band around collar for clean finish
- HH LifaLoft™ logo at front left chest



65703 W LIFALOFT FULL ZIP INSULATOR

USD \$160

Sizes:
XS-XL

Fitting:
Regular

CB/Inseam:
44cm

Insulation:
LIFALOFT™ 80g
insulation

Water column: **Weight:**

Fabric:
100% Polyamide

Colours:
991 Black

Features:

- LIFALOFT™ insulation by Primaloft®
- Water resistant and windproof fabric
- Fiber and down proof fabric construction
- PFC Free DWR LIFALOFT™ unique quilt design
- YKK® CF zipper and dual YKK® zipped hand warmer pockets.
- Full side zipper for easy on and off
- Snap buttons for secure closure
- Placket behind zipper for added wind protection
- Back pocket
- Stretch panels for optimized fit



65757 W LIFALOFT SKIRT

USD \$120

Sizes:
XS-XL

Fitting:
Regular

CB/Inseam:

Insulation:

Water column: **Weight:**

Fabric:
Shell: 100% Polyamide -
Insulation: 70% Polypropylene,
30% Polyester
- Lining: 100% Polyamide

Colours:
990 Black

Features:

- LIFALOFT™ insulation by Primaloft®
- Fiber and down proof fabric construction
- PFC Free Durable Water Repellency (DWR) treatment
- Full side zip opening
- YKK® zip closure
- Soft fleece side panels for optimal fit and comfort
- HH® LIFALOFT™ logo at front





WOMEN'S MOUNTAIN

62908 W ODIN MOUNTAIN 3L SHELL JACKET

USD \$600



Sizes: XS-XL
Fitting: Regular
CB/Inseam: 70cm

Insulation: **Water column:** 20000/20000
Weight:

Fabric:
Face: 100% Polyamide
Back: 100% Polyamide

Colours:
 065 Raspberry
 615 Bluebird
 983 Slate

- Features:**
- HELLY TECH® Professional fabric
 - 3-layer lightweight fabric construction
 - C6 DWR and Microporous membrane
 - 100% polyamide face and back with woven backing
 - 20,000gm WP & 20,000gm MVP
 - Waterproof, Windproof and breathable
 - 11 degree angle Odin chest pocket
 - Helmet, backpack and harness compatible construction and pockets
 - Minimal build, custom fit and removable snow skirt



ODIN
 Inspired by Norse mythology, the Odin series is developed with and tested by mountain guides around the world to achieve the most complete and purposeful weather protection.

62909 W ODIN MOUNTAIN 3L SHELL BIB PANT

USD \$475



Sizes: XS-XL
Fitting: Regular
CB/Inseam: 78cm

Insulation: **Water column:** 20000/20000
Weight:

Fabric:
Face: 100% Polyamide
Back: 100% Polyamide

Colours:
 218 Pinot Rose
 983 Slate

- Features:**
- HELLY TECH® Professional fabric
 - 3-layer lightweight fabric construction
 - C6 DWR and Microporous membrane
 - 100% polyamide face and back with woven backing
 - 20,000gm WP & 20,000gm MVP
 - Waterproof, Windproof and breathable
 - Softshell bib construction inspired by yoga pants for extra comfort, cross over design to fit all body types
 - Bib pocket with integrated D-ring for beacon attachment



62910 W ODIN MOUNTAIN SOFTSHELL JACKET

USD \$325



Sizes: XS-XL
Fitting: Regular
CB/Inseam: 70cm

Insulation: **Water column:**
Weight:

Fabric:
Face: 82% Polyamide, 18% Elastane / **Back:** 100% Polyester

Colours:
 065 Raspberry
 611 Blue Mountain
 983 Slate

- Features:**
- 4-way stretch softshell fabric
 - C6 DWR
 - Hybrid construction with membrane fabric at top for weather protection and no-membrane fabric on body for maximum breathability
 - Grid fleece backing for optimal performance and comfort
 - Windproof and breathable
 - Vertical and horizontal hood adjustment
 - Laminated brim with flat contrast piping and double cord brim shape for full angle view



62911 W ODIN MOUNTAIN SOFTSHELL PANT

USD \$300



Sizes: XS-XL
Fitting: Regular
CB/Inseam: 78cm

Insulation: **Water column:**
Weight:

Fabric:
Face: 82% Polyamide, 18% Elastane / **Back:** 74% Polyester, 26% Bamboo

Colours:
 983 Slate

- Features:**
- 4-way stretch softshell fabric
 - C6 DWR
 - Hybrid construction with membrane fabric at front leg up to knee and back seat for weather protection, and no-membrane fabric for maximum breathability
 - Slick feel backing for optimal performance and comfort
 - Windproof and breathable
 - Right side thigh pocket with WR zipper and integrated D-ring for beacon attachment
 - Left side thigh pocket with easy access fastener closure



WOMEN'S MOUNTAIN



63020 W ODIN LIFALOFT DOWN HYBRID

USD \$400



Sizes: XS-XL
 Fitting: Regular
 CB/Inseam:

Insulation: Water column: Weight:

Fabric: 100% Polyamide

Colours: 065 Raspberry 990 Black

Features:

- Allied® Down 800FP 90/10 Goose Down
- LIFALOFT™ insulation by Primaloft®80g
- 7D down proof main fabric
- Double down baffle construction to avoid cold spots
- Lightweight & breathable
- Packable into stuff sack
- Body mapped construction for optimal advantage of down and LIFALOFT™ insulation by Primaloft® properties
- Warm when wet, warm when cold
- LIFALOFT™ insulation by Primaloft® specific quilting inside to highlight the LIFALOFT™ insulation by Primaloft® panels



- LIFALOFT™
- ALLIED Down
- Dual down baffle construction for maximum warmth and no cold spots
- Body mapped construction for optimal advantage of LIFALOFT™ and Down properties
- Packable into stuff sack



065

62956 W ODIN 9 WORLDS 2.0 JACKET

USD \$400



Sizes: XS-XL
Fitting: Regular
CB/Inseam: 69,5cm

Insulation: 20000mm
Water column: 20000mm
Weight:

Features:

- HELLY TECH® Professional fabric is built with 3-layer, 100% polyamide 70D X 70D face & 100% polyurethane back
- 20,000gm WP & 15,000gm moisture vapor permeability
- Waterproof, Windproof and breathable
- DWR C6 + hydrophilic lamination
- hard-shell fit provides maximum protection from the elements over long journeys, whilst allowing different layering options underneath
- Helmet and backpack compatible design

Fabric: 79% Cotton, 18% Polyester, 3% Elastane

Colours: 065 Raspberry
 615 Bluebird
 990 Black



065

615

990

62957 W ODIN LIGHT 3D SHELL JACKET

USD \$350



Sizes: XS-XL
Fitting: Regular
CB/Inseam: 75,5cm

Insulation: 20.000mm
Water column: 20.000mm
Weight:

Features:

- HELLY TECH® Professional fabric
- 2,75L fabric construction with 3D backing
- Extreme ventilation
- Packable anorak design that converts into a versatile waist bag
- Secure phone pocket
- Light weight construction
- Helmet and backpack compatible design

Fabric: Face: 100% Polyamide / Back: 100% Polyester

Colours: 615 Bluebird
 990 Black



615

990

62832 W ODIN STRETCH HOODED INSULATOR JACKET USD \$260



Sizes: XS-XL
Fitting: Regular
CB/Inseam: 69cm

Insulation: 20000mm
Water column: 20000mm
Weight:

Features:

- 1L lightweight 30D fabric
- 4-way stretch fabric
- Primaloft® Gold Active+ 80gInsulation
- Stretch lining
- Durable Water Repellency (DWR) treatment
- Full inner front placket
- YKK® zippers
- Seamless underarm stretch panels
- Hood with sculpted brim
- Soft edge band around hood and cuffs
- Hi vis details

Fabric: Face: 100% Polyamide / Back: 100% Polyester

Colours: 065 Raspberry
 640 Ice Blue
 991 Black



065

640

991

62924 W ODIN STRETCH HOODED LIGHT INSULATOR JACKET USD \$230



Sizes: XS-XL
Fitting: Regular
CB/Inseam: 69cm

Insulation: Primaloft® Active Gold+ Insulation 40g
Water column: 20000mm
Weight:

Features:

- Lightweight 30D fabric
- 4-way stretch fabric
- Stretch lining
- Durable Water Repellency (DWR) treatment
- Primaloft® Gold Active + 40gstretch Insulation
- Full inner front placket
- YKK® zippers
- Seamless underarm stretch panels
- Hood with sculpted brim
- Soft edge band around hood and cuffs
- Hi vis details

Fabric: 90% Polyamide, 10% Elastane

Colours: 060 Misty Rose
 615 Bluebird
 991 Black



060

615

991



62958 W ODIN STRETCH LIGHT INSULATOR VEST USD \$180

Sizes: XS-XL
Fitting: Regular
CB/Inseam: 69cm

Insulation: **Water column:** **Weight:**

Fabric:
 Face: 100% Polyamide / Back: 100% Polyurethane

Colours:
 065 Raspberry
 597 Navy
 991 Black

- Features:**
- Lightweight 30D fabric
 - 4-way stretch fabric
 - Stretch lining
 - Durable Water Repellency (DWR) treatment
 - Primaloft® Gold Active + 40gstretch Insulation
 - YKK® zippers
 - Seamless underarm stretch panels



065



597



991

62764 W ODIN MUNINN PANT USD \$200

Sizes: XS-XL
Fitting: Regular
CB/Inseam: 82cm

Insulation: **Water column:** **Weight:**

Fabric:
 94% Polyamide, 6% Elastane

Colours:
 990 Slate
 983 Black

- Features:**
- Durable stretch, soft and flexible softshell fabric
 - Water repellant, Windproof and breathable
 - Durable Water Repellency (DWR) treatment
 - Softshell dynamic fit allowing comfortable movement during variable conditions
 - Well rounded, active fit provides comfort and protection for most daytime conditions
 - Articulated knees for optimal mobility
 - Boot hooks at front leg hem
 - Gusset in crotch for freedom of movement



990



983



62835 W VERGLAS 3L SHELL JACKET USD \$325

Sizes: XS-XL
Fitting: Regular
CB/Inseam: 70cm

Insulation: **Water column:** **Weight:**
 20000mm

Fabric:
 90% Polyamide, 10% Elastane

Colours:
 615 Bluebird
 662 Wild Rose
 990 Black

- Features:**
- HELLY TECH® Professional fabric
 - 3-layer fabric construction
 - 100% Polyamide 70D x 70D face & 100% polyurethane back
 - 20,000gm WP & 15,000gm moisture vapor permeability
 - Waterproof, Windproof and breathable
 - DWR C6 + hydrophilic lamination
 - Hard-shell fit provides maximum protection from the elements while allowing different layering options underneath



615



662



990

MOUNTAIN ESSENTIALS

The essential collection for the classic mountain lover. Technical materials are thoughtfully combined with versatile design, creating great quality mountain pieces that can be enjoyed for years of adventure.

63021 W VERGLAS 3L SHELL PANT USD \$275

Sizes: XS-XL
Fitting: Regular
CB/Inseam: 82cm

Insulation: **Water column:** **Weight:**
 33000/2100

Fabric:
 100% Polyamide

Colours:
 662 Wild Rose
 990 Black

- Features:**
- HELLY TECH® Professional fabric
 - 3-layer shell fabric construction
 - 100% polyamide 70D X 70D face fabric
 - Waterproof, Windproof, breathable & fully seam sealed
 - C6 DWR
 - Flexible hem boot lock construction with hook and ladder system
 - YKK® zippers
 - 7/8 side zip with 2-way zip for ventilation
 - Secure WR zip thigh pocket
 - Boot hooks at front leg hem
 - Adjustable waist

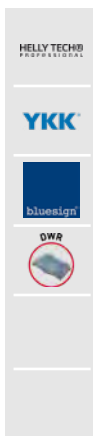

662



990

63022 W VERGLAS TUR PANT

USD \$250

Sizes: XS-XL
Fitting: Regular
CB/Inseam: 81,5cm

Insulation:
Water column:
Weight:

Fabric:
 94% Polyamide,
 6% Elastane

Colours:
 218 Pinot Rose
 983 Slate

Features:

- Durable poly/cotton mix main fabric with mechanical stretch
- PFC DWR
- Durable 4-way stretch softshell panels at knees, seat and crotch gusset
- Oekotex certified fabric
- Flexible hem boot lock construction with hook and ladder system
- 7/8 side zip with 2-way zip for ventilation
- 4 zipped secure pockets
- Boot hooks at front leg hem
- Reinforced insteps at hem
- Integrated Adjustable waist with fastener

YKK

Oeko-TEX®
certified by TESTEX



218



983

63023 W VEIR TUR PANT

USD \$200

Sizes: XS-XL
Fitting: Regular
CB/Inseam: 81,5cm

Insulation:
Water column:
Weight:

Fabric:
 Shell: 67% Polyester, 33% Cotton - Shell 2: 94% Polyamide, 6% Elastane

Colours:
 218 Pinot Rose
 983 Slate

Features:

- Durable poly/cotton mix main fabric with mechanical stretch
- PFC DWR
- Durable 4-way stretch softshell panels at seat, knees and crotch gusset
- Oekotex certified fabric
- Flexible hem boot lock construction with hook and ladder system
- Side zip for ventilation
- 2 front pockets with flap, 1 secure zipped
- Boot hooks at front leg hem
- Reinforced insteps at hem
- Beltloops at waistband

YKK

Oeko-TEX®
certified by TESTEX



983



218

62813 W VANIR HYBRID PANT

USD \$120

Sizes: XS-XL
Fitting: Fitted
CB/Inseam: 81cm

Insulation:
Water column:
Weight:

Fabric:
 89% Polyester, 11% Elastane

Colours:
 597 Navy
 980 Ebony

Features:

- Durable stretch, soft and flexible softshell fabric
- Water repellent, Windproof and breathable
- Softshell dynamic fit allowing comfortable movement during variable conditions
- Well rounded, active design provides comfort and protection for many conditions

YKK



597



980



62864 W RASK TIGHTS

USD \$85

Sizes: XS-XL
Fitting: Fitted
CB/Inseam: 69,5cm

Insulation:
Water column:
Weight:

Fabric:
 96% Polyester, 4% Elastane

Colours:
 662 Wild Rose
 990 Black

Features:

- 4-way stretch technical 28gknit with wicking properties
- Stretch reinforcement panels with DWR on seat and knees
- 100% fabric
- YKK® zipped pocket at hip

YKK



662



990

63024 W VERGLAS ICEFALL DOWN JACKET

USD \$350

Sizes: XS-XL
 Fitting: Regular
 CB/Inseam: 72cm

Insulation: Water column: Weight:

Fabric: 100% Polyamide

Colours: 065 Raspberry
 615 Bluebird
 990 Black

- Features:**
- 20D Nano ripstop down proof fabric
 - Allied® Down 85/15 European goose
 - Primaloft® Silver water resistant insulation 133g in hood, shoulder panels, sides, underarms and sleeve ends
 - PFC free DWR
 - Packable into stuff sack
 - Adjustable hood
 - Full inner CF storm flap for wind block
 - Two front hand pockets
 - One inside chest pocket
 - YKK® zippers
 - Velcro adjustable sleeve ends



065



615



990

63027 W VERGLAS HOODED DOWN INSULATOR JACKET

USD \$300

Sizes: XS-XL
 Fitting: Regular
 CB/Inseam: 70cm

Insulation: Water column: Weight:

Fabric: 100% Polyamide

Colours: 065 Raspberry
 640 Ice Blue
 662 Wild Rose
 990 Black

- Features:**
- 20D Nano ripstop down fabric
 - Allied® Down 85/15 European goose
 - Fill power 700+
 - C6 DWR
 - YKK® zippers
 - Two front hand pockets
 - 1 inner chest pocket
 - Full inner front placket for wind block
 - Snug down filled hood
 - Clean finish elastic hem and sleeve end construction
 - Inner neck hanger loop



640



065



662



990

63028 W VERGLAS DOWN INSULATOR JACKET

USD \$275

Sizes: XS-XL
 Fitting: Regular
 CB/Inseam: 70cm

Insulation: Water column: Weight:

Fabric: 100% Polyamide

Colours: 065 Raspberry
 640 Ice Blue
 662 Wild Rose
 990 Black

- Features:**
- 20D Nano ripstop down fabric
 - Allied® Down 85/15 European goose
 - Fill power 700+
 - C6 DWR
 - YKK® zippers
 - Two front hand pockets
 - 1 inner chest pocket
 - Full inner front placket for wind block
 - Clean finish elastic hem and sleeve end construction
 - Inner neck hanger loop



640



065



662



990

63026 W VERGLAS HOODED DOWN HYBRID INSULATOR JACKET

USD \$280

Sizes: XS-XL
 Fitting: Regular
 CB/Inseam: 70cm

Insulation: Water column: Weight:

Fabric: 100% Polyamide

Colours: 060 Misty Rose
 597 Navy
 615 Bluebird
 990 Black

- Features:**
- Hybrid construction
 - 20D Nano ripstop down fabric paired with breathable softshell panels at underarm, sides, back shoulder and lower cuffs
 - Allied® Down 85/15 European goose in body
 - Fill power 700+
 - Primaloft® Silver insulation 60g in hood and shoulder panels
 - C6 DWR
 - YKK® zippers
 - Two front hand pockets
 - 1 inner chest pocket

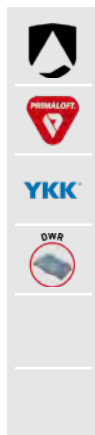

060



597



615



990



WOMEN'S MOUNTAIN

63029 W VERGLAS LONG DOWN INSULATOR JACKET USD \$300

Sizes: XS-XL
Fitting: Regular
CB/Inseam: 90cm

Insulation: Water column: Weight:

Fabric: 100% Polyamide

Colours: 662 Wild Rose
990 Black

- Features:**
- 20D Nano ripstop down fabric
 - Allied® Down 85/15 European goose
 - Fill power 700+
 - C6 DWR
 - YKK® zippers
 - Two front hand pockets
 - 1 inner chest pocket
 - Full inner front placket for wind block
 - Snug down filled hood
 - Clean finish elastic sleeve ends
 - Inner neck hanger loop



662



990

63030 W VERGLAS DOWN INSULATOR VEST USD \$250

Sizes: XS-XL
Fitting: Regular
CB/Inseam: 67cm

Insulation: Water column: Weight:

Fabric: 100% Polyamide

Colours: 065 Raspberry
990 Black

- Features:**
- 20D Nano ripstop down fabric
 - Allied® Down 85/15 European goose
 - Fill power 700+
 - C6 DWR
 - YKK® zippers
 - Two front hand pockets
 - 1 inner chest pocket
 - Full inner front placket for wind block
 - Adjustable bottom hem
 - Inner neck hanger loop



065



990

62964 W VERGLAS LIGHT HOODIE USD \$75

Sizes: XS-XL
Fitting: Regular
CB/Inseam: 65cm

Insulation: Water column: Weight:

Fabric: 86% Polyamide, 14% Elastane

Colours: 615 Bluebird
662 Wild Rose
853 Grey Fog

- Features:**
- Super soft 205g fabric with elastane
 - Wicking properties
 - Flat drawcord adjustment in hood



615



662



853

62965 W VERGLAS 1/2 ZIP USD \$75

Sizes: XS-XL
Fitting: Regular
CB/Inseam: 65cm

Insulation: Water column: Weight:

Fabric: 49% Polyamide, 45% Polyester, 6% Elastane

Colours: 615 Bluebird
662 Wild Rose
853 Grey Fog
Melange

- Features:**
- Super soft 205g fabric with elastane
 - Wicking properties
 - YKK® front zipper



615



662



853

62966 W VERGLAS 7/8 TIGHTS

USD \$65

Sizes: XS-XL
Fitting: Fitted
CB/Inseam: 63cm

Insulation:
Water column:
Weight:

Fabric:
 49% Polyamide,
 45% Polyester, 6%
 Elastane

Colours:
 662 Wild Rose
 990 Black

- Features:**
- 4-way stretch technical 28gknit with wicking properties
 - 100% Bluesign® approved fabric
 - Low profile right thigh pocket under flap



662



990

62967 W VERGLAS PACE T-SHIRT

USD \$40

Sizes: XS-XL
Fitting: Regular
CB/Inseam: 65cm

Insulation:
Water column:
Weight:

Fabric:
 88% Polyester, 12%
 Elastane

Colours:
 218 Pinot Rose
 615 Bluebird
 971 Quiet Shade

- Features:**
- Bluesign® approved fabric
 - Wicking properties



218



615



971

62988 W PARAMOUNT HOODED SOFTSHELL JACKET USD \$160

Sizes: XS-XL
Fitting: Regular
CB/Inseam:

Insulation:
Water column:
Weight:

Fabric:
 Face: 90%
 Polyester, 10%
 Elastane / Back:
 100% Polyurethane

Colours:
 597 Navy
 990 Black

- Features:**
- Water resistant, windproof and breathable
 - Comfortable and light softshell fabric with a membrane
 - Hood with cord adjustments
 - Fleece backing
 - YKK® full front zip
 - Adjustable cuffs
 - YKK® zipped hand pockets
 - YKK® zipped chest pocket
 - Chin guard



597



990

62925 W PARAMOUNT SOFTSHELL JACKET

USD \$130

Sizes: XS-XL
Fitting: Regular
CB/Inseam:

Insulation:
Water column:
Weight:

Fabric:
 90% Polyamide,
 10% Elastane

Colours:
 597 Navy
 990 Black

- Features:**
- Water resistant, windproof and breathable
 - Comfortable and light softshell fabric with a membrane
 - Fleece backing
 - YKK® full front zip
 - Adjustable cuffs
 - YKK® zipped hand pockets
 - YKK® zipped chest pocket
 - Chin guard



597



990



62926 W PARAMOUNT SOFTSHELL VEST

USD \$110

Sizes: XS-XL
Fitting: Regular
CB/Inseam:
Insulation:
Water column:
Weight:

Fabric:
 Face: 90% Polyester, 10% Elastane / Back: 100% Polyurethane
Colours:
 597 Navy
 990 Black

- Features:**
- Water resistant, windproof and breathable
 - Comfortable and light softshell fabric with a membrane
 - Fleece backing
 - YKK® full front zip
 - YKK® zipped hand pockets
 - YKK® zipped chest pocket
 - Chin guard

YKK



597



990

62282 W LOKE JACKET

USD \$100

Sizes: XS-4XL
Fitting: Regular
CB/Inseam: 68cm
Insulation:
Water column: 10000mm
Weight:

Fabric:
 Face: 100% Polyamide / Back: 100% Polyurethane
Colours:
 047 Snow Nmm Map
 065 Raspberry
 482 Beluga
 597 Navy
 662 Wild Rose
 990 Black

- Features:**
- HELLY TECH® Performance, with 2.5 layer 100% polyester fabric with 100% polyurethane laminate
 - 10,000mm Waterproofness and 10,000gm moisture vapor permeability
 - Waterproof, Windproof, breathable
 - fully seam sealed

HELLY TECH® PERFORMANCE

YKK



047



990



065



482



597



662



62266 W LOKE PANTS

USD \$85

Sizes: XS-4XL
Fitting: Regular
CB/Inseam: 78cm
Insulation:
Water column: 10000mm
Weight:

Fabric:
 Face: 100% Polyamide / Back: 100% Polyurethane
Colours:
 990 Black

- Features:**
- HELLY TECH® Performance, with 2.5 layer 100% polyester fabric with 100% polyurethane laminate
 - 10,000mm Waterproofness and 10,000gm moisture vapor permeability
 - Waterproof, Windproof, breathable & fully seam sealed
 - Durable Water Repellency (DWR) treatment

HELLY TECH® PERFORMANCE

YKK



990



63032 W HOVIN INSULATED JACKET

USD \$250

Sizes: XS-XL
Fitting: Regular
CB/Inseam: 76cm
Insulation:
Water column: 7500
Weight:

Fabric:
 Shell: 100% Polyester - Lining: 100% Polyamide
 - Insulation body: 100% Recycled Polyester - Insulation sleeves: 100% Recycled Polyester
Colours:
 218 Pinot Rose
 597 Navy
 857 Pelican

- Features:**
- 2-layer HELLY TECH® Protection main fabric
 - PFC free DWR
 - Fully taped
 - Primaloft® Black ECO 100% recycled insulation, 60g in body and 40g in hood/sleeves
 - 2 zipped hand pockets and 2 flap pockets at front
 - 1 inside zipped chest pocket
 - YKK® zippers
 - Adjustable hood
 - Front placket with snap closure



YKK



218



597



857

HELLY TECH® PERFORMANCE

FJORD TIL FJELL

The Fjord til Fjell collection captures the essence of the Helly Hansen identity and the Norwegian outdoor lifestyle – the adventures from the fjord to the mountains! Inspired by the spectacular Norwegian nature, we have developed a collection of multi-purpose, lightweight technical gear that caters for all your adventure and travel requirements. Great looking, practical and functional – this line will work whether you set out for an adventure by the fjords, hike up to the top of the mountain or enjoy a cup of coffee in the city.

63031 W GREFSEN 2L SHELL JACKET

USD \$150

Sizes: XS-XL
Fitting: Regular
CB/Inseam: 73,5cm

Insulation: **Water column:** 12500/4800
Weight:

Fabric: 100% Polyester

Colours: 581 Marine Blue
 597 Navy
 662 Wild Rose
 990 Black

Features:

- HELLY TECH® Protection
- Waterproof, windproof and breathable
- 2-layer construction
- Fully seam sealed
- PFC Free DWR
- Lined for comfort
- Quick dry lining
- Fixed hood
- One hand hood adjustments
- Front storm flap
- YKK® front zipper
- YKK® zipped hand pockets
- Adjustable cuffs



581



597



662



990

63033 W LINDE INSULATED ANORAK

USD \$220

Sizes: XS-XL
Fitting: Regular
CB/Inseam: 73,5cm

Insulation: **Water column:**
Weight:

Fabric: Shell: 100% Polyester - Lining: 100% Polyamide - Lining 2: 100% Polyester - Insulation sleeves: 100% Recycled Polyester

Colours: 482 Beluga
 597 Navy
 719 Cedar Brown

Features:

- Polyester fabric treated with care for water resistance
- PFC Free DWR
- Bluesign® approved fabric
- Sherpa insulated body and hood
- Primaloft Black ECO, 40g insulation sleeves
- Anorak 1/2 zip closure
- 1 big front anorak zipped pocket
- 2 front zipped hand pockets
- YKK® zippers
- Internal waist drawcord adjustment on back panel



482



597



719

63034 W LINDE INSULATED VEST

USD \$160

Sizes: XS-XL
Fitting: Regular
CB/Inseam: 70cm

Insulation: **Water column:** 7500
Weight:

Fabric: Shell: 100% Polyester - Lining: 100% Polyester - Insulation body: 100% Recycled Polyester

Colours: 218 Pinot Rose
 597 Navy
 857 Pelican

Features:

- Polyester fabric treated with care for water resistance
- PFC Free DWR
- Bluesign® approved fabric
- Sherpa insulated body and hood
- Full Center front zipper
- 2 front hand pockets
- YKK® zippers

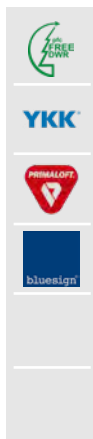

218



597



857

63035 W MALMOYA ZIP PILE

USD \$100

Sizes: XS-XL
Fitting: Regular
CB/Inseam: 70cm

Insulation: **Water column:**
Weight:

Fabric: 100% Polyester

Colours: 034 Cream
 218 Pinot Rose
 980 Ebony

Features:

- Soft high loft brushed pile fabric
- Full Center front zipper
- YKK® zippers
- 2 front hand pockets



034



218



980



62928 W WOOL KNIT SWEATER

USD \$175

Sizes: XS-XL
Fitting: Regular
CB/Inseam: 64cm

Insulation: **Water column:** **Weight:**

Fabric: 65% Merino Wool, 35% Nylon

Features:

- Soft merino wool blend knitted sweater
- 65% Merino Wool 35% Nylon
- Fun and playful colors and graphics
- Raglan sleeves
- 1x1 rib at bottom hem and collar

Colours:
 034 Cream
 597 Navy
 857 Pelican



034



597

857



63043 W ODDEN STRIPE KNIT SWEATER

USD \$110

Sizes: XS-XL
Fitting: Regular
CB/Inseam: 64cm

Insulation: **Water column:** **Weight:**

Fabric: 60% Organic Cotton, 40% Recycled Polyester

Features:

- Soft merino wool blend knitted sweater
- 65% Merino Wool 35% Nylon
- Fun and playful colors and graphics
- Raglan sleeves
- 1x1 rib at bottom hem and collar

Colours:
 034 Cream
 597 Navy



034



597



63037 W LILLO SWEATER

USD \$120

Sizes: XS-XL
Fitting: Regular
CB/Inseam: 66cm

Insulation: **Water column:** **Weight:**

Fabric: Shell: 98% Polyester, 2% Elastane - Shell 2: 100% Polyester

Features:

- Quilted polyester jersey fabric
- Contrast panels on collar and shoulders
- PFC Free DWR
- 100% Bluesign® approved fabric
- Pullover with snap closure
- Chest pocket
- Adjustable bottom hem

Colours:
 034 Cream
 060 Misty Rose
 980 Ebony



034



060

980



63044 W LILLO LONG ZIP

USD \$130

Sizes: XS-XL
Fitting: Regular
CB/Inseam: 81cm
Insulation:
Water column:
Weight:

Fabric:
 Shell: 98% Polyester, 2% Elastane - Shell 2: 100% Polyester
Colours:
 034 Cream
 060 Misty Rose
 980 Ebony

Features:
 • Quilted polyester jersey fabric
 • Contrast panels on collar
 • PFC Free DWR
 • 100% Bluesign® approved fabric
 • YKK® full front zipper
 • 2 front hand pockets
 • Adjustable bottom hem



034



060



980

63038 W HOLMEN 5 POCKET PANT

USD \$100

Sizes: XS-XL
Fitting: Regular
CB/Inseam: 81cm
Insulation:
Water column:
Weight:

Fabric:
 100% Polyester
Colours:
 706 Aluminum
 980 Ebony

Features:
 • Warp stretch twill weave fabric
 • 100% Bluesign® approved fabric
 • Gusset at crotch for freedom of movement
 • Front hand pockets
 • Back welt pockets
 • Secure YKK® zip pocket at thigh



980



706

62929 W WOOL TRAVEL PANT

USD \$170

Sizes: XS-XL
Fitting: Regular
CB/Inseam: 70cm
Insulation:
Water column:
Weight:

Fabric:
 60% Recycled wool, 36.5% Viscose, 2.5% Polyamide, 1% Elastane
Colours:
 598 Navy
 972 Quiet Shade

Features:
 • Stretchy, soft and comfortable wool mix fabric
 • 60% Recycled wool, 36.5% Viscose, 2.5% Polyamide, 1% Elastane
 • Super soft and comfortable recycled wool
 • Elastic waist and bottom hem with flat front
 • Hip hand pockets and back zipped pocket
 • Articulated pattern construction



598



972

63039 W MYRA LEGGINGS

USD \$75

Sizes: XS-XL
Fitting: Fitted
CB/Inseam: 68cm
Insulation:
Water column:
Weight:

Fabric:
 Shell: 89% Polyester, 11% Elastane
Colours:
 662 Wild Rose
 Melange
 990 Black Melange

Features:
 • Brushed knit legging material
 • Bluesign® approved fabric
 • Wide elastic yoga waistband
 • 2 side slit pockets



662



990



63040 W MALMOYA HOODED DRESS

USD \$130

Sizes: XS-XL
Fitting: Regular
CB/Inseam: 93cm

Insulation:
Water column:
Weight:

Fabric:
 Shell: 100% Polyester

- Features:**
- Soft high loft brushed pile fabric
 - YKK® 1/2 zip opening
 - Two front hand pockets
 - Cozy sleeveless hood design

Colours:
 034 Cream
 Melange
 662 Wild Rose
 980 Ebony

YKK



034



662



980

62930 W CLASSIC CHECK LS SHIRT

USD \$75

Sizes: XS-XL
Fitting: Regular
CB/Inseam: 71cm

Insulation:
Water column:
Weight:

Fabric:
 100% Cotton

- Features:**
- The classic checked flannel shirt!
 - 185g 100% cotton flannel fabric
 - Front chest pocket
 - Buttoned front and cuffs

Colours:
 034 Cream Plaid
 421 Lav Green Plaid
 640 Ice Blue Plaid
 662 Wild Rose Plaid



640



034



421



662

62931 W OSLO LS SHIRT

USD \$75

Sizes: XS-XL
Fitting: Regular
CB/Inseam: 71cm

Insulation:
Water column:
Weight:

Fabric:
 46% Cotton,
 24% Polyester,
 16% Acrylic,
 13% Viscose, 1%
 Elastane,

- Features:**
- Classic style long sleeve button up shirt
 - Mélange flannel and multi-colored slub colorways
 - Front chest pocket

Colours:
 034 Cream
 218 Pinot Rose
 597 Navy Slub



218



034



597

62932 W HYTTE DRESS

USD \$90

Sizes: XS-XL
Fitting: Regular
CB/Inseam: 87,5cm

Insulation:
Water column:
Weight:

Fabric:
 Face: 80% Cotton,
 20% Polyester
 / Back: 100%
 Polyester

- Features:**
- Warm and cozy long sleeve dress
 - Poly/cotton 300g fabric
 - Dropped needle stitched fabric technique for a structured finish
 - Front slanted hand pockets
 - 1x1 rib at neck, cuffs and hem

Colours:
 482 Beluga
 662 Wild Rose
 981 Ebony



482



662



981

62936 W F2F COTTON HOODIE

USD \$60

Sizes: XS-XL
Fitting: Regular
CB/Inseam: 65cm

Insulation:
Water column:
Weight:

Fabric:
 80% Cotton, 20% Polyester

- Features:**
- Polyester/ cotton mix jersey hoodie
 - Fun and playful graphics
 - Front kangaroo pocket
 - Front Adjustable hood
 - 1x1 rib at cuffs and hem

Colours:
 034 Cream
 Melange
 421 Lav Green
 581 Marine Blue
 981 Ebony Melange



034



421

581

981

62935 W F2F COTTON SWEATER

USD \$50

Sizes: XS-XL
Fitting: Regular
CB/Inseam: 65cm

Insulation:
Water column:
Weight:

Fabric:
 80% Cotton, 20% Polyester

- Features:**
- Polyester / crew neck sweater
 - Fun and playful graphics
 - 1x1 rib at cuffs, neck and bottom hem

Colours:
 034 Cream
 Melange
 060 Misty Rose
 Melange
 421 Lav Green
 981 Ebony Melange



034



060

421

981

63041 W HYGGEN LONGSLEEVE

USD \$70

Sizes: XS-XL
Fitting: Regular
CB/Inseam: 65cm

Insulation:
Water column:
Weight:

Fabric:
 100% Polyester

- Features:**
- Lightweight double face knit
 - Soft and comfortable
 - 100% Bluesign@approved fabric
 - Angular cut shape on sleeves and side hem for a feminine look
 - YKK@ invisible right side seam zipper

Colours:
 034 Cream
 482 Beluga
 581 Marine Blue



034



482

581

62877 W SKOG GRAPHIC T-SHIRT

USD \$40

Sizes: XS-XL
Fitting: Regular
CB/Inseam: 65cm

Insulation:
Water column:
Weight:

Fabric:
 88% Polyester, 12% Elastane

- Features:**
- Recycled polyester fabric
 - Versatile tee for all conditions
 - 100% fabric
 - UPF 30
 - Various custom graphic print designs

Colours:
 034 Cream
 581 Marine Blue
 640 Ice Blue
 980 Ebony



034



581

640

980



WOMEN'S MOUNTAIN

62980 W NORD GRAPHIC FZ HOODIE

USD \$70

Sizes: XS-2XL
Fitting: Regular
CB/Inseam:
Insulation:
Water column:
Weight:

Fabric:
 60% Cotton, 40% Polyester

Colours:
 597 Navy
 615 Bluebird
 662 Wild Rose
 Melange
 949 Grey Melange

- Features:**
- Cotton polyester mix fabric
 - Helly Hansen® Nord graphic on left chest
 - YKK® center front zipper
 - Front pockets
 - Adjustable hood with drawcord



597



615

662

949

62981 W NORD GRAPHIC PULL OVER HOODIE

USD \$60

Sizes: XS-2XL
Fitting: Regular
CB/Inseam:
Insulation:
Water column:
Weight:

Fabric:
 80% Cotton, 20% Polyester

Colours:
 096 Ash Rose
 Melange
 597 Navy
 615 Bluebird
 949 Grey Melange

- Features:**
- Cotton polyester mix fabric
 - Helly Hansen® Nord graphic across chest
 - Kangaroo pocket
 - Adjustable hood with drawcord



096



597

615

949

62983 W NORD GRAPHIC LONGSLEEVE T-SHIRT

USD \$40

Sizes: XS-2XL
Fitting: Regular
CB/Inseam: 71cm
Insulation:
Water column:
Weight:

Fabric:
 80% Cotton, 20% Polyester

Colours:
 001 White
 096 Ash Rose
 Melange
 597 Navy

- Features:**
- Cotton polyester mix fabric
 - Helly Hansen® Nord graphic across chest
 - Crew neck style



001



096

597



WOMEN'S BASE LAYER

49373 W LIFA MERINO HEAVYWEIGHT 1/2 ZIP

USD \$140

Sizes: XS-XL
Fitting: Regular
CB/Inseam: 65cm

Insulation:
Water column:
Weight: 250G/M2

Fabric:
 65% Merino Wool,
 35% Polypropylene

Colours:
 597 Navy
 662 Wild Rose
 990 Black

- Features:**
- 2-layer construction
 - 250g LIFA® Merino fabric
 - Brushed interior
 - 1/2 zip construction
 - Non-itch
 - Flat lock seams

lifa



YKK



597



662

990

49374 W LIFA MERINO HEAVYWEIGHT CREW

USD \$130

Sizes: XS-XL
Fitting: Regular
CB/Inseam: 65cm

Insulation:
Water column:
Weight: 250G/M2

Fabric:
 65% Merino Wool,
 35% Polypropylene

Colours:
 213 Cayenne
 597 Navy
 662 Wild Rose
 990 Black

- Features:**
- 2-layer construction
 - 250g LIFA® Merino fabric
 - Brushed interior
 - Non-itch
 - Flat lock seams

lifa



213



597

662

990

49375 W LIFA MERINO HEAVYWEIGHT PANT

USD \$110

Sizes: XS-XL
Fitting: Regular
CB/Inseam: 79cm

Insulation:
Water column:
Weight: 250G/M2

Fabric:
 65% Merino Wool,
 35% Polypropylene

Colours:
 597 Navy
 990 Black

- Features:**
- 2-layer construction
 - 250g LIFA® Merino fabric
 - Brushed interior
 - Non-itch
 - Flat lock seams

lifa



597



990

49376 W LIFA MERINO MIDWEIGHT HOODIE

USD \$120

Sizes: XS-XL
Fitting: Regular
CB/Inseam: 65cm

Insulation:
Water column:
Weight: 225G/M2

Fabric:
 57% Merino Wool,
 43% Polypropylene

Colours:
 011 Off White
 615 Bluebird
 662 Wild Rose

- Features:**
- 2-layer construction
 - Hood for added warmth
 - 100% Merino Wool exterior
 - 225g LIFA® Merino fabric
 - Non-itch
 - Flat lock seams

lifa



PR

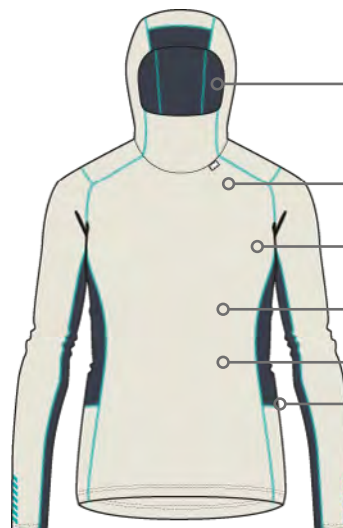

Hood for added warmth

2-layer construction

100% Merino Wool exterior

225g LIFA® Merino fabric

Non-itch

Flat lock seams



662



615

LIFA MERINO MIDWEIGHT is perfect for any type of activity in cold weather. A unique 2-in-1 base layer with 100% merino wool combined with LIFA® Stay Warm Technology in a 2 layer construction. LIFA® Merino MIDWEIGHT delivers all the great benefits of merino wool fibers plus the unique properties of technical LIFA® fibers.

WOMENS 'S BASE LAYER



49377 W LIFA MERINO MIDWEIGHT 1/2 ZIP

USD \$110

Sizes: XS-XL
Fitting: Regular
CB/Inseam: 65cm

Insulation:
Water column:
Weight: 225G/M2

Fabric:
57% Merino Wool,
43% Polypropylene

Colours:
011 Off White
213 Cayenne
255 Liberty
525 Turquoise
597 Navy
990 Black

- Features:**
- 2-layer construction
 - 1/2 zip construction
 - 100% Merino Wool exterior
 - 225g LIFA® Merino fabric
 - Non-itch
 - Flat lock seams



525



990



213



255



011



597

49378 W LIFA MERINO MIDWEIGHT CREW

USD \$100

Sizes: XS-XL
Fitting: Regular
CB/Inseam: 65cm

Insulation:
Water column:
Weight: 225G/M2

Fabric:
57% Merino Wool,
43% Polypropylene

Colours:
011 Off White
213 Cayenne
255 Liberty
525 Turquoise
597 Navy
615 Bluebird
662 Wild Rose
990 Black

- Features:**
- 2-layer construction
 - 100% Merino Wool exterior
 - 225g LIFA® Merino fabric
 - Non-itch
 - Flat lock seams



662



615



011



990



213



255



525



597

WOMEN'S BASE LAYER

49379 W LIFA MERINO MIDWEIGHT GRAPHIC CREW USD \$110

Sizes: XS-XL
Fitting: Regular
CB/Inseam: 65cm

Insulation:
Water column:
Weight: 225G/M2

Fabric:
 57% Merino Wool,
 43% Polypropylene

Colours:
 011 Off White
 096 Ash Rose
 213 Cayenne
 597 Navy
 662 Wild Rose
 990 Black

- Features:**
- 2-layer construction
 - 100% Merino Wool exterior
 - 225g LIFA® Merino fabric
 - Non-itch
 - Flat lock seams



011



990



096



213



597



662

49380 W LIFA MERINO MIDWEIGHT PANT USD \$100

Sizes: XS-XL
Fitting: Regular
CB/Inseam: 78cm

Insulation:
Water column:
Weight: 225G/M2

Fabric:
 57% Merino Wool,
 43% Polypropylene

Colours:
 011 Off White
 597 Navy
 662 Wild Rose
 990 Black

- Features:**
- 2-layer construction
 - 100% Merino Wool exterior
 - 225g LIFA® Merino fabric
 - Non-itch
 - Flat lock seams

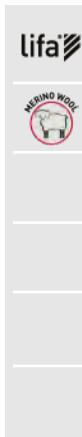

662



597



011



990

49381 W LIFA MERINO MIDWEIGHT 3/4 PANT USD \$80

Sizes: XS-XL
Fitting: Regular
CB/Inseam: 56cm

Insulation:
Water column:
Weight: 225G/M2

Fabric:
 57% Merino Wool,
 43% Polypropylene

Colours:
 990 Black

- Features:**
- 2-layer construction
 - 3/4 length
 - 100% Merino Wool exterior
 - 225g LIFA® Merino fabric
 - Non-itch
 - Flat lock seams



990

49382 W LIFA MERINO LIGHTWEIGHT HOODIE USD \$110

Sizes: XS-XL
Fitting: Regular
CB/Inseam: 64cm

Insulation:
Water column:
Weight: 160G/M2

Fabric:
 70% Merino Wool,
 30% Polypropylene

Colours:
 597 Navy
 662 Wild Rose

- Features:**
- 2-layer construction
 - Hood for added warmth
 - 1/2 zip construction
 - 100% Merino Wool exterior
 - 160g LIFA® Merino fabric
 - Non-itch
 - Flat lock seams



597



662

49383 W LIFA MERINO LIGHTWEIGHT 1/2 ZIP USD \$100

Sizes: XS-XL
Fitting: Regular
CB/Inseam: 64cm

Insulation:
Water column:
Weight: 160G/M2

Fabric:
 70% Merino Wool,
 30% Polypropylene

Features:

- 2-layer construction
- 1/2 zip construction
- 100% Merino Wool exterior
- 160g LIFA® Merino fabric
- Non-itch
- Flat lock seams

Colours:
 255 Liberty
 597 Navy
 662 Wild Rose



255



597



662

49384 W LIFA MERINO LIGHTWEIGHT CREW USD \$90

Sizes: XS-XL
Fitting: Regular
CB/Inseam: 64cm

Insulation:
Water column:
Weight: 160G/M2

Fabric:
 70% Merino Wool,
 30% Polypropylene

Features:

- 2-layer construction
- 100% Merino Wool exterior
- 160g LIFA® Merino fabric
- Non-itch
- Flat lock seams

Colours:
 065 Raspberry
 255 Liberty
 597 Navy
 615 Bluebird



065



255



597



615

49385 W LIFA MERINO LIGHTWEIGHT GRAPHIC CREW USD \$100

Sizes: XS-XL
Fitting: Regular
CB/Inseam: 64cm

Insulation:
Water column:
Weight: 160G/M2

Fabric:
 70% Merino Wool,
 30% Polypropylene

Features:

- 2-layer construction
- 100% Merino Wool exterior
- 160g LIFA® Merino fabric
- Non-itch
- Flat lock seams

Colours:
 011 Off White Ikat
 662 Wild Rose
 Camo
 990 Black Camo



011



662



990

49386 W LIFA MERINO LIGHTWEIGHT PANT USD \$90

Sizes: XS-XL
Fitting: Regular
CB/Inseam: 78cm

Insulation:
Water column:
Weight: 160G/M2

Fabric:
 70% Merino Wool,
 30% Polypropylene

Features:

- 2-layer construction
- 100% Merino Wool exterior
- 160g LIFA® Merino fabric
- Non-itch
- Flat lock seams

Colours:
 597 Navy
 662 Wild Rose



597



662



WOMEN'S BASE LAYER

48497 W HH MERINO MID 1/2 ZIP

USD \$110

Sizes: XS-XL
Fitting: Regular
CB/Inseam: 67cm

Insulation:
Water column:
Weight: 195G/M2

Fabric: 100% Merino Wool

Features:

- 100% Merino wool
- 19,5 micron
- Non Mulesed
- Flat lock stitches
- 195g/m2 fabric

Colours:
 662 Wild Rose
 930 Grey Melange
 991 Black



662



930

991

48473 W HH MERINO MID GRAPHIC 1/2 ZIP

USD \$140

Sizes: XS-XL
Fitting: Regular
CB/Inseam: 67cm

Insulation:
Water column:
Weight: 195G/M2

Fabric: 100% Merino Wool

Features:

- 100% Merino wool
- 19,5 micron
- Non Mulesed
- Flat lock stitches
- 195g/m2 fabric

Colours:
 597 Navy
 662 Wild Rose
 990 Black



597



662

990

48496 W HH MERINO MID LS

USD \$100

Sizes: XS-XL
Fitting: Regular
CB/Inseam: 67cm

Insulation:
Water column:
Weight: 195G/M2

Fabric: 100% Merino Wool

Features:

- 100% Merino wool
- 19,5 micron
- Non Mulesed
- Flat lock stitches
- 195g/m2 fabric

Colours:
 597 Navy
 662 Wild Rose
 930 Grey Melange
 990 Black



662



597

930

990

49307 W HH MERINO MID GRAPHIC LS

USD \$110

Sizes: XS-XL
Fitting: Regular
CB/Inseam: 67cm

Insulation:
Water column:
Weight: 195G/M2

Fabric: 100% Merino Wool

Features:

- 100% Merino wool
- 19,5 micron
- Non Mulesed
- Flat lock stitches
- 195g/m2 fabric

Colours:
 597 Navy
 599 Navy
 662 Wild Rose
 663 Wild Rose
 965 Charcoal
 990 Black



662



990



599

597

663

965



48499 W HH MERINO MID PANT

USD \$90

Sizes: XS-XL
Fitting: Regular
CB/Inseam: 79cm

Insulation:
Water column:
Weight: 195G/M2

Fabric: 100% Merino Wool

Colours:
 930 Grey Melange
 990 Black

- Features:**
- 100% Merino wool
 - 19,5 micron
 - Non Mulesed
 - Flat lock stitches
 - 195g/m2 fabric



49308 W HH MERINO MID GRAPHIC PANT

USD \$130

Sizes: XS-XL
Fitting: Regular
CB/Inseam: 79cm

Insulation:
Water column:
Weight: 195G/M2

Fabric: 100% Merino Wool

Colours:
 597 Navy
 662 Wild Rose
 990 Black

- Features:**
- 100% Merino wool
 - 19,5 micron
 - Non Mulesed
 - Flat lock stitches
 - 195g/m2 fabric

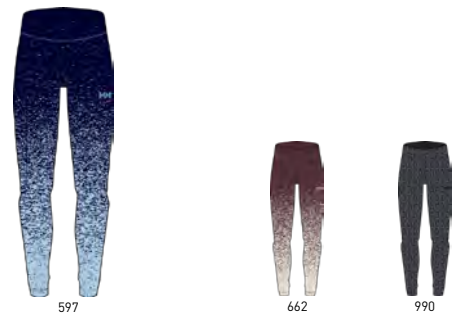

49392 W LIFA ACTIVE 1/2 ZIP

USD \$65

Sizes: XS-XL
Fitting: Regular
CB/Inseam: 66cm

Insulation:
Water column:
Weight: 130G/M2

Fabric: 65% Polyester, 35% Polypropylene

Colours:
 065 Raspberry
 597 Navy
 697 Lilatech
 980 Ebony

- Features:**
- 2-layer construction
 - Excellent moisture management properties
 - 1/2 zip construction
 - LIFA® fibers interior
 - Wicking polyester exterior
 - Flat lock seams

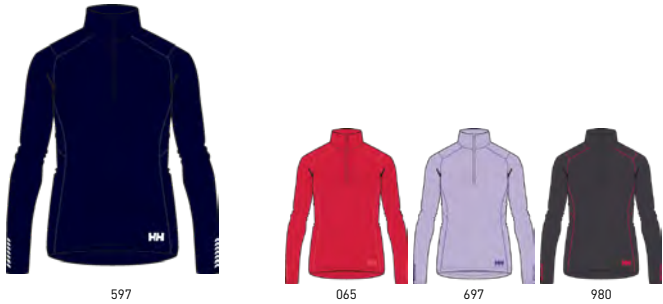

49393 W LIFA ACTIVE CREW

USD \$55

Sizes: XS-XL
Fitting: Regular
CB/Inseam: 64cm

Insulation:
Water column:
Weight: 130G/M2

Fabric: 65% Polyester, 35% Polypropylene

Colours:
 065 Raspberry
 597 Navy
 615 Bluebird
 697 Lilatech
 980 Ebony

- Features:**
- 2-layer construction
 - Excellent moisture management properties
 - LIFA® fibers interior
 - Wicking polyester exterior
 - Flat lock seams



WOMEN'S BASE LAYER

49401 W LIFA ACTIVE GRAPHIC CREW

USD \$65

Sizes: XS-XL
Fitting: Regular
CB/Inseam: 64cm

Insulation:
Fabric: 65% Polyester, 35% Polypropylene

Colours:
 001 White
 597 Navy
 615 Bluebird

Water column:
Weight: 130G/M2

Features:

- 2-layer construction
- Excellent moisture management properties
- LIFA® fibers interior
- Wicking polyester exterior
- Flat lock seams

lifa



001



597

615

49394 W LIFA ACTIVE PANT

USD \$50

Sizes: XS-XL
Fitting: Regular
CB/Inseam: 79cm

Insulation:
Fabric: 65% Polyester, 35% Polypropylene

Colours:
 065 Raspberry
 255 Liberty
 597 Navy
 990 Black

Water column:
Weight: 130G/M2

Features:

- 2-layer construction
- Excellent moisture management properties
- LIFA® fibers interior
- Wicking polyester exterior
- Flat lock seams

lifa



065



255



597



990

48326 W HH LIFA CREW

USD \$45

Sizes: XS-XL
Fitting: Regular
CB/Inseam: 67cm

Insulation:
Fabric: 100% Polypropylene

Colours:
 001 White
 065 Raspberry
 597 Navy
 990 Black

Water column:
Weight: 125G/M2

Features:

- Lightweight insulation
- 100% LIFA®
- Flatlock seams for max comfort
- Natural stretch fabric

lifa



065



001



597



990

48331 W HH LIFA PANT

USD \$40

Sizes: XS-XL
Fitting: Regular
CB/Inseam: 78cm

Insulation:
Fabric: 100% Polypropylene

Colours:
 597 Navy
 990 Black

Water column:
Weight: 125G/M2

Features:

- Lightweight insulation
- 100% LIFA®
- Flatlock seams for max comfort
- Natural stretch fabric

lifa



990



597

48374 W HH TECH CREW LS

USD \$30.00

Sizes:
XS|S|M|L|XL

Fitting:
Regular

CB/Inseam:
66cm

Fabric:
100% Polyester

Water column: **Weight:**
140g/m2

Features:

- Synthetic fabric
- Quick dry and Wicking
- Flatlock seams for next to skin comfort
- 140gm/m2 fabric

Colours:
001 White
597 Navy
980 Ebony
930 Light grey

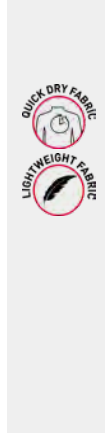

597



980



001



930

TECH

The HH Tech collection provides wearers with a quick drying and UPF rated garment. It is a lightweight fabric that is ideal to wear in hot conditions.

48373 W HH TECH T-SHIRT

USD \$25.00

Sizes:
XS|S|M|L|XL

Fitting:
Regular

CB/Inseam:
66cm

Fabric:
46% Polyester,
39% Polyamide,
10% Tencel, 5%
Elastane

Water column: **Weight:**
140g/m2

Features:

- Synthetic fabric
- Quick dry and Wicking
- Flatlock seams for next to skin comfort
- 140gm/m2 fabric

Colours:
001 White
597 Navy
980 Ebony
930 Light grey

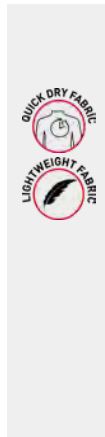

597



001



980



930



WOMEN'S MIDLAYER

51888 W POWER AIR HEAT GRID JACKET

USD \$200

Sizes: XS-XL
Fitting: Regular
CB/Inseam: 64cm

Insulation:
Water column:
Weight: 350G/M2

Fabric:
 89% Recycled Polyester, 11% Elastane

Colours:
 034 Cream
 662 Wild Rose
 990 Black

- Features:**
- Polartec® Power Air
 - Efficient warmth
 - Sheds at least 5x less microfibers
 - Highly durable
 - Resists Pilling
 - Dual-surface construction



662



034

990

51889 W POWER STRETCH PRO GLACIER HOODED JACKET

USD \$230

Sizes: XS-XL
Fitting: Regular
CB/Inseam: 67cm

Insulation:
Water column:
Weight: 250G/M2

Fabric:
 56% Polyester, 34% Polyamide, 10% Elastane

Colours:
 615 Bluebird
 662 Wild Rose
 990 Black

- Features:**
- Polartec® Power Stretch Pro
 - 4-way stretch
 - Superior abrasion resistance
 - Highly breathable
 - Wicks moisture
 - Fast drying
 - Shape retention



615



662

990

51890 W POWER STRETCH PHANTOM 1/2 ZIP 3.0

USD \$130

Sizes: XS-XL
Fitting: Regular
CB/Inseam: 67cm

Insulation:
Water column:
Weight: 225G/M2

Fabric:
 84% Recycled Polyester, 16% Elastane

Colours:
 213 Cayenne
 597 Navy
 615 Bluebird

- Features:**
- Polartec® Power Stretch
 - 4-way stretch
 - Highly breathable
 - Wicks moisture
 - Fast drying
 - Shape retention



597



213

615

51892 W VARDE HOODED FLEECE JACKET

USD \$140

Sizes: XS-XL
Fitting: Regular
CB/Inseam: 67cm

Insulation:
Water column:
Weight: 330G/M2

Fabric:
 100% Polyester

Colours:
 096 Ash Rose
 853 Grey Fog
 983 Slate

- Features:**
- Knitted fleece
 - Polyester woven fabric on hood for added protection
 - YKK® zipper



096



853

983



WOMEN'S MIDLAYER

51862 W VARDE FLEECE JACKET

USD \$125

Sizes: XS-XL
Fitting: Regular
CB/Inseam: 67cm
Insulation: Water column: Weight: 330G/M2
Fabric: 100% Polyester
Features:
 • Knitted fleece
 • Polyester woven fabric side panels
 • YKK® zipper

Colours:
 096 Ash Rose
 640 Ice Blue
 662 Wild Rose
 853 Grey Fog
 983 Slate



853



640



662



096



983

51861 W VARDE FLEECE 1/2 ZIP

USD \$110

Sizes: XS-XL
Fitting: Regular
CB/Inseam: 67cm
Insulation: Water column: Weight: 330G/M2
Fabric: 100% Polyester
Features:
 • Knitted fleece
 • Polyester woven fabric side panels
 • YKK® zipper

Colours:
 096 Ash Rose
 640 Ice Blue
 662 Wild Rose
 853 Grey Fog
 983 Slate



640



096



662



853



983

WOMEN'S MIDLAYER

54283 W ASTRAL JACKET

USD \$165

Sizes: XS-XL
Fitting: Regular
CB/Inseam: 62cm

Insulation: Water column: **Weight:** 230G/M2

Fabric: 92% Polyester, 8% Elastane

Colours: 615 Bluebird, 662 Wild Rose, 990 Black

- Features:**
- Soft Herringbone jersey 230g/m² on sleeves, upper part and body sides, combined with insulated, wind resistant and water repellent polyester panels in body front and back.
 - Primaloft® Black insulation 100g/m² in body
 - Double breasted front with YKK® zipper closure at front side
 - High, soft and comfortable padded collar
 - Draw cord adjustment on top of collar
 - Snap closure on front collar
 - Hand pockets with YKK® zipper closure

YKK



662



615

990

51798 W PRECIOUS FLEECE JACKET

USD \$110

Sizes: XS-XL
Fitting: Regular
CB/Inseam: 67cm

Insulation: Water column: **Weight:** 320G/M2

Fabric: 100% Polyester

Colours: 012 Off White, 662 Wild Rose, 980 Ebony

- Features:**
- High loft brushed 2-sided fleece
 - Softshell reinforcements
 - High neck collar
 - YKK® zipper

YKK



012



662

980

51848 W PRECIOUS PULL OVER FLEECE

USD \$100

Sizes: XS-XL
Fitting: Regular
CB/Inseam: 67cm

Insulation: Water column: **Weight:** 320G/M2

Fabric: 100% Polyester

Colours: 011 Off White, 662 Wild Rose, 980 Ebony

- Features:**
- High loft brushed 2-sided fleece
 - Softshell reinforcements
 - High neck collar
 - Pull-over



662



011

980

51860 W LYRA JACKET

USD \$130

Sizes: XS-XL
Fitting: Regular
CB/Inseam: 68cm

Insulation: Water column: **Weight:** 325G/M2

Fabric: 100% Polyester

Colours: 011 Off White, 060 Misty Rose, 980 Ebony

- Features:**
- Two-sided brushed fleece
 - Offset front zip
 - Hand pockets
 - YKK® zipper

YKK



060



011

980

51859 W LYRA 1/2 ZIP

USD \$110

Sizes: XS-XL
Fitting: Regular
CB/Inseam: 68cm

Insulation:
Water column:
Weight: 325G/M2

Fabric:
 100% Polyester

- Features:**
- Two-sided brushed fleece
 - Offset 1/2 zip
 - Hand pockets
 - YKK® zipper

Colours:
 011 Off White
 060 Misty Rose
 980 Ebony



011



060

980

51863 W FEATHER PILE JACKET

USD \$120

Sizes: XS-XL
Fitting: Regular
CB/Inseam: 67cm

Insulation:
Water column:
Weight: 285G/M2

Fabric:
 100% Polyester

- Features:**
- Lightweight pile
 - 2-sided brushed fleece
 - Full zip
 - Lycra edge band at neck, cuff and hem
 - YKK® zipper

Colours:
 034 Cream
 597 Navy
 662 Wild Rose



034



597

662

51812 W HH MERINO HOODED JACKET

USD \$250

Sizes: XS-XL
Fitting: Regular
CB/Inseam: 67cm

Insulation:
Water column:
Weight: 300G/M2

Fabric:
 100% Merino Wool

- Features:**
- 100% Merino Wool Fleece
 - Pockets with zip
 - Merino wool pocket linings
 - YKK® Zippers
 - Snug fit hood
 - Brushed inside

Colours:
 980 Ebony



980

51832 W MARKA WOOL SWEATER

USD \$150

Sizes: XS-XL
Fitting: Regular
CB/Inseam: 62cm

Insulation:
Water column:
Weight:

Fabric:
 100% Wool

- Features:**
- 100% Wool
 - Knitted wool midlayer
 - YKK® Zippers
 - High neck collar
 - Thumb holes
 - Waffle knit exterior
 - Brushed Fleece interior
 - 1/2 Zip chest construction

Colours:
 597 Navy
 662 Wild Rose
 931 Grey Melange



597



662

931



WOMEN'S MIDLAYER

51894 W DAYBREAKER LOGO HOODIE

USD \$65

Sizes: XS-XL
Fitting: Relaxed
CB/Inseam: 67cm

Insulation:
Water column:
Weight: 160G/M2

Fabric:
 100% Recycled Polyester

Colours:
 001 White
 213 Cayenne
 597 Navy
 990 Black

- Features:**
- Polartec®
 - Hood for added warmth and comfort
 - Kangaroo pocket
 - Flatlock seams for low bulk
 - Embossed HH® logo



51599 W DAYBREAKER FLEECE JACKET

USD \$65

Sizes: XS-XL
Fitting: Regular
CB/Inseam: 67cm

Insulation:
Water column:
Weight: 160G/M2

Fabric:
 100% Recycled Polyester

Colours:
 004 White
 213 Cayenne
 525 Turquoise
 599 Navy
 662 Wild Rose
 991 Black
 994 Graphite Blue

- Features:**
- Polartec®
 - Full zip construction
 - Side pockets with zip
 - YKK® zipper Flatlock seams for low bulk
 - HH® logo embroidery at the chest



50845 W DAYBREAKER 1/2 ZIP FLEECE

USD \$55

Sizes: XS-XL
Fitting: Regular
CB/Inseam: 67cm

Insulation:
Water column:
Weight: 160G/M2

Fabric:
 100% Recycled Polyester

Colours:
 007 White
 213 Cayenne
 525 Turquoise
 599 Navy
 662 Wild Rose
 990 Black
 994 Graphite Blue

- Features:**
- Polartec®
 - 1/2 Zip construction
 - YKK® Zipper
 - Flatlock seams for low bulk
 - HH® logo embroidery at the chest



51743 W DAYBREAKER FLEECE PANT

USD \$60

Sizes: XS-XL
Fitting: Regular
CB/Inseam: 76,5cm

Insulation:
Water column:
Weight: 160G/M2

Fabric:
 100% Recycled Polyester

Colours:
 990 Black

- Features:**
- Polartec® 100g
 - Elasticated waist
 - Flatlock seams for low bulk
 - Hand Pockets
 - Tapered Legs
 - Inseam pant (size M) 76,5cm





53546 W JPN QUILTED COAT

USD \$400

Sizes: XS-XL
Fitting: Regular
CB/Inseam: 93cm

Insulation: Highloft down feel blowable synthetic insulation
Fabric: Shell: 100% Polyamide

Colours: 597 Navy
 857 Pelican

Water column:
Weight:

Features:

- Down proof shell fabric
- Soft and lightweight down proof lining
- Downfeel ultrasoft microfiber insulation
- Large puffy adjustable hood
- Storm flap with hidden snap closure down front
- Adjustable bottom hem
- YKK® 2-way front zipper
- Multiple exterior hand and storage pockets
- Knitted wrist gaiters for extra warmth and comfort
- Inside stash pockets for safe keeping of your belongings

YKK®



597



857

JPN CONNECTION

This collection is the result of an inspired collaboration between Helly Hansen Japan and Helly Hansen Norway. Focusing on the similarities of Japanese and Norwegian craftsmanship, the designs reflect the attention to details and pursuit of simplicity, elevating raw beauty and the shared passion for water and natural light.

53549 W JPN PUFFY JACKET

USD \$350

Sizes: XS-XL
Fitting: Regular
CB/Inseam: 60cm

Insulation: Highloft down feel blowable synthetic insulation
Fabric: Shell: 85% Polyester, 15% Polyamide

Colours: 597 Navy
 640 Ice Blue
 857 Pelican

Water column: 9220/12720
Weight:

Features:

- Corduroy or oxford shell fabric depending on colour
- Highloft down feel blowable synthetic insulation
- Large puffy and adjustable snap off hood
- Hand pockets with YKK® zip closure and fleece lining for extra warmth
- YKK® 2-way front zipper with stormflap
- Elastic inside cuffs
- Inside stash pocket
- Adjustable bottom hem
- Embroidered HH logo at sleeve

YKK®



597



640



857

53402 W JPN RAINCOAT

USD \$200

Sizes: XS-XL
Fitting: Regular
CB/Inseam: 88cm

Insulation:
Water column: 5000mm
Weight:

Fabric: Shell: 100% Polyester - Lining: 100% Polyester

Colours: 597 Navy
 598 Navy Denim
 703 Sandstorm Print

Features:

- HELLY TECH® Protection fabric
- Waterproof, windproof and breathable
- 2-layer construction
- Fully seam sealed
- Durable Water Repellency (DWR) treatment
- YKK® Vislon front zipper with back placket
- Hand pockets with hidden snap closure
- Hanging hood with adjustable drawcord
- Adjustable bottom hem
- Elasticated cuffs for snug fit
- Ventilation under back yoke

HELLY TECH® PROTECTION

YKK®



597



598



703



WOMEN'S URBAN

53547 W JPN REVERSIBLE COAT

USD \$220

Sizes:
XS-XL

Fitting:
Regular

CB/Inseam:
97cm

Insulation:
Primaloft® Black
Eco 80gr

Water column: **Weight:**

Fabric:
Shell: 100%
Polyester

Features:

- Reversible quilted coat with lightweight Primaloft insulation
- Printed No More Mondays artwork inside cc 857, and printed HH heritage check inside on cc 597
- Snap button closure down front
- Hand pockets
- Side split
- HH® logo embroidery on sleeve
- Inside JPN storytelling label

Colours:
597 Navy
857 Pelican



597



857



597

53313 W JPN CORD JACKET

USD \$250

Sizes: XS-XL
Fitting: Regular
CB/Inseam: 69cm

Insulation:
Water column:
Weight:

Fabric:
 Face: 100% Polyester / Back: 100% Polyurethane

Colours:
 597 Navy
 857 Pelican

- Features:**
- Bonded 3L corduroy fabric with soft pile backing
 - High protective collar
 - YKK® 2-way front zipper
 - Large hand pockets for storage
 - Inside mesh stash pockets for safe keeping of your belongings
 - Black metal HH logo on sleeve cuff
 - Inside JPN storytelling label



597



857

53404 W JPN SPRING JACKET

USD \$140

Sizes: XS-XL
Fitting: Regular
CB/Inseam: 66cm

Insulation:
Water column:
Weight:

Fabric:
 100% Polyester

Colours:
 421 Lav Green Print
 597 Navy

- Features:**
- Lightweight polyester main fabric
 - Durable Water Repellency (DWR) treatment
 - Primaloft® Black Eco insulation, 60g
 - Quilted channels
 - Buttoned front
 - Round collar
 - Two hand pockets with snap closure
 - Loose fit with dropped shoulders
 - Rounded bottom hem with binding
 - Inside JPN Connections story label
 - HH® logo on sleeve



421



597

53301 W TUNDRA DOWN COAT

USD \$400

Sizes: XS-XL
Fitting: Regular
CB/Inseam: 107cm

Insulation:
Water column:
Weight:

Fabric:
 100% Polyester

Colours:
 034 Cream
 482 Beluga
 990 Black

- Features:**
- Warm and lightweight down coat
 - PFC free water repellent treatment
 - Traceable down from Allied, 80/20, 600 FP
 - 2-way YKK® WR zipper at front
 - Inner pocket
 - Primaloft® on shoulder area to avoid cold spots
 - Two hand pockets with snap closure
 - High, soft collar and large hood with adjustment possibilities



034



482



990

53218 W SVALBARD 2 PARKA

USD \$300

Sizes: XS-XL
Fitting: Regular
CB/Inseam: 81cm

Insulation:
Water column:
Weight:

Fabric:
 Face: 100% Polyamide / Back: 100% Thermoplastic Polyurethane

Colours:
 217 Spice
 482 Beluga
 857 Pelican
 990 Black

- Features:**
- HELLY TECH® Protection
 - Waterproof, windproof and breathable
 - Fully seam sealed
 - Durable Water Repellency (DWR) treatment
 - Primaloft® Black Eco insulation, 200g/m² in body, 170g/m² in sleeves and hood
 - YKK® quality zippers at front and hand warmer pockets
 - Adjustable hood with zip off faux fur
 - Knitted wrist gaiters for extra warmth and comfort
 - Fold up reflective at sleeve for extra visibility and safety



217



482



857



990

53500 W REGINA PARKA

USD \$350

Sizes: XS-XL
Fitting: Relaxed
CB/Inseam: 91cm

Insulation: 100% recycled PET blowable synthetic insulation
Water column: 6000/8500
Weight:

Fabric: Shell: 100% Polyamide - Lining: 100% Polyester - Lining 2: 100% Polyamide - Insulation: 100% Recycled Polyester

Colours: 349 Arrowwood
 421 Lav Green
 990 Black

Features:

- Waterproof, windproof and breathable shell fabric
- Durable Water Repellency (DWR) treatment
- YKK® quality zipper at front with storm flap for extra protection
- Adjustable hood with zip off faux fur
- Knitted wrist gaiters for extra warmth and comfort
- Fold up reflective at sleeve for extra visibility and safety
- Inside waist adjustment



349



421



990

53503 W ARYA PARKA

USD \$330

Sizes: XS-XL
Fitting: Regular
CB/Inseam: 90cm

Insulation: 100% recycled PET blowable synthetic insulation
Water column:
Weight:

Fabric: Shell: 100% Polyester - Lining: 100% Polyester

Colours: 300 Patrol Orange
 421 Lav Green
 857 Pelican
 990 Black

Features:

- Waterproof, windproof and breathable shell fabric
- Durable Water Repellency (DWR) treatment
- YKK® quality zipper at front with buttoned storm flap for extra protection
- Adjustable large and comfy hood
- Knitted wrist gaiters for extra warmth and comfort
- Adjustable hem
- Double entry hand pockets with button closure on top, and side entry hand warmer pockets
- HH® badge on sleeve



300



421



857



990

53191 W SENSE DOWN JACKET

USD \$320

Sizes: XS-XL
Fitting: Regular
CB/Inseam: 65cm

Insulation: 15400/21000
Weight:

Fabric: Face: 100% Polyurethane / Back: 100% Polyester

Colours: 388 Winter Sun
 421 Lav Green
 991 Black

Features:

- Down proof shell fabric
- Soft and lightweight down proof lining
- PFC free water repellency treatment
- 60/40 Duck down, 480 fill power
- YKK® water-resistant front zipper
- Two hand pockets and chest pocket with YKK® zip closure
- Extra high protective puffy collar with adjustment on top
- YKK® zipper in both sides with fan for customized fit and look
- Knitted wrist gaiters for extra warmth and comfort



388



421



991

53303 W MAYEN PARKA

USD \$250

Sizes: XS-XL
Fitting: Regular
CB/Inseam: 93cm

Insulation: Primaloft® Black Eco Insulation, 133g/m² in body, 100g/m² in sleeves
Water column: 12500/4800
Weight:

Fabric: Face: 100% Polyester / Back: 100% Polyurethane

Colours: 034 Cream
 222 Alert Red
 421 Lav Green
 597 Navy
 990 Black

Features:

- HELLY TECH® Protection
- Waterproof, windproof and breathable
- Fully seam sealed
- Primaloft® Black Eco insulation, 133g/m² in body, 100g/m² in sleeves
- Soft pile lining in hood
- 2-way YKK® Vislon zipper down front and chest pocket
- Adjustable hood with removable faux fur
- Front storm flap with hidden snap closure
- Multiple interior and exterior pockets
- Handwarmer pockets with hidden snap closure



034



222



421



597



990



WOMEN'S URBAN

54429 W ADEN DOWN PARKA

USD \$300

Sizes: XS-XL
Fitting: Regular
CB/Inseam: 90cm

Insulation: Water column: Weight:
Features:

Fabric:
 Face: 100% Polyester / Back: 100% Polyurethane

Colours:
 483 Beluga
 597 Navy
 990 Black

- HELLY TECH® Protection fabric
- Waterproof, windproof and breathable
- Durable Water Repellency (DWR) treatment
- Allied® Down 60/40, 480 Fill power
- Removable Faux fur at hood
- YKK® 2-way front zipper and storm flap with hidden snap closure
- Hand pockets with YKK® zip closure
- Adjustable hood
- Embroidered HH logo on sleeve
- Regular fit
- Center back length size M: 90cm



483



597



990

54430 W BLUME PUFFY PARKA

USD \$250

Sizes: XS-XL
Fitting: Regular
CB/Inseam: 85cm

Insulation: Water column: Weight:
Features:

Fabric:
 Face: 100% Polyester / Back: 100% Polyurethane

Colours:
 011 Off White
 060 Misty Rose
 162 Red
 482 Beluga
 991 Black

- Waterproof, windproof and breathable
- Durable Water Repellency (DWR) treatment
- Fully insulated with high loft synthetic insulation
- Detachable and adjustable hood
- Removable Faux fur at hood
- YKK® 2-way front zipper covered with storm flap
- Hand pockets with YKK® zip closure
- HH metal badge on sleeve
- Regular fit



011



060



162



482



991

53215 W LEONIE DOWN JACKET

USD \$250

Sizes: XS-XL
Fitting: Regular
CB/Inseam: 60cm

Insulation: Allied® Down, 80/20, 600 FP
Water column: Weight:

Fabric:
 100% Polyamide

Colours:
 388 Winter Sun
 483 Beluga
 980 Ebony

- Down proof shell fabric
- Allied® Down filling, 80/20, 600 fill power
- Brushed tricot inside hand pockets for extra warmth and comfort
- Knitted rib collar
- Elasticated inside of cuffs
- Back placket down front for extra protection
- YKK® front and hand pocket zippers
- HH badge on sleeve



YKK



388



483



980

53506 W URBAN LINER COAT

USD \$240

Sizes: XS-XL
Fitting: Regular
CB/Inseam: 91cm

Insulation: 100% recycled PET down feel blowable synthetic insulation
Water column: Weight:

Fabric:
 Shell: 100% Polyester - Lining 2: 100% Polyester - Insulation: 100% Recycled Polyester

Colours:
 482 Beluga
 857 Pelican
 990 Black

- Doubleweave stitch free channels for insulation
- 100% recycled insulation
- Hand pockets with YKK® hidden zip closure
- All seams inside binded with self fabric
- Inside pocket
- Mono material information print inside
- HH® logo on sleeve

YKK



482



857



990

53507 W URBAN LINER

USD \$200

Sizes: XS-XL
Fitting: Regular
CB/Inseam: 59cm

Insulation: 100% recycled PET down feel blowable synthetic insulation
Water column:
Weight:

Fabric:
 Shell: 100% Polyester - Lining 2: 100% Polyester - Insulation: 100% Recycled Polyester

Colours:
 096 Ash Rose
 349 Arrowwood
 482 Beluga
 857 Pelican
 990 Black

Features:

- Doubleweave stitch free channels for insulation
- 100% recycled insulation
- Hand pockets with hidden snap button closure
- All seams inside banded with self fabric
- Inside pocket
- Mono material information print inside
- HH® logo on sleeve



096



857



482



349

NO
CAD

990

Built on the idea of making garment recycling easier, this super comfortable insulator combines Urban design lines with singular material construction. The entire jacket, except the zipper slider, is made of polyester that can easily be recycled. Doubleweave stitch free channels with recycled light weight polyester insulation and a soft main fabric.

MONO MATERIAL

100% Recyclable

This garment is made with one single material, without any mixed fibers. Using mono material in a garment makes it easier to recycle and a better resource in a circular system, where the goal is textile to textile recycling.

53512 W RIGGING COAT

USD \$350

Sizes: XS-XL
Fitting: Regular
CB/Inseam: 97cm

Insulation: Primaloft® Black Eco 100gr
Water column: 15400/21000
Weight:

Fabric:

Colours:
 597 Navy
 857 Pelican
 990 Black

Features:

- 3 in 1 waterproof, breathable coat
- Adjustable hanging hood
- Handwarmer pockets with hidden snap closure
- Secure chest pocket
- Double entry hand pockets
- Fold up reflective at sleeves
- Adjustable cuffs
- Internal waist adjustment
- YKK® 2-way front zipper with stormflap for extra protection
- Multiple HH® logos
- Zip out long hooded insulator with 100gr Primaloft® Black eco insulation



597



857



990

53517 W ASPIRE RAIN COAT

USD \$200

Sizes: XS-XL
Fitting: Regular
CB/Inseam: 100cm

Insulation: Primaloft® Black Eco 60gr
Water column: 12500/4800
Weight:

Fabric:
 Shell: 100% Polyester - Lining: 100% Polyester - Insulation: 80% Recycled Polyester, 20% Polyester

Colours:
 349 Arrowwood
 482 Beluga
 990 Black

Features:

- Waterproof, windproof and breathable insulated raincoat
- Durable Water Repellency (DWR) treatment
- Primaloft® Black 60gr insulation
- Adjustable hanging hood
- YKK® 2-way front zipper and back placket for extra protection
- Hand pockets with fleece lining and YKK® zip closure
- Wrist gaitors for extra warmth and comfort
- Adjustable cuffs and bottom hem



349



482



990



62395 W LONG BELFAST WINTER JACKET

USD \$185

- Sizes:** XS-XL
Fitting: Regular
CB/Inseam: 86cm
- Insulation:** 5000mm
Water column: 5000mm
Weight:
- Fabric:**
 Face: 100% Polyester / Back: 100% Polyurethane
- Colours:**
 482 Beluga
 597 Navy
 857 Pelican
 980 Ebony
 991 Black
- Features:**
- HELLY TECH® Protection
 - Waterproof, windproof and breathable
 - 2-layer fabric construction
 - Fully seam sealed
 - Durable Water Repellency (DWR) treatment
 - Primaloft® Black 60gr insulation
 - Quick dry lining
 - Fixed hood
 - Vislon center front zip
 - Zipped hand pockets
 - Adjustable cuffs
 - Bottom hem Cinch cord



53314 W WELSEY II TRENCH INSULATED

USD \$240

- Sizes:** XS-XL
Fitting: Fitted
CB/Inseam: 89cm
- Insulation:** Primaloft® Black Eco Insulation 80g/m2
Water column: 12500/4800
Weight:
- Fabric:**
 Face: 100% Polyester / Back: 100% Polyurethane
- Colours:**
 482 Beluga
 598 Navy
 990 Black
- Features:**
- HELLY TECH® Protection
 - Waterproof, windproof and breathable
 - Fully seam sealed
 - Durable Water Repellency (DWR) treatment
 - Primaloft® Black Eco 60g/m2 quilted lining
 - Packable hood
 - YKK® front zipper with double breasted snap button closure
 - Detachable belt
 - YKK® zipped hand pockets
 - Embroidered HH® logo on sleeve



PROTECTION
 This performance-driven rainwear concept adapts seamlessly to the active, corporate and casual lifestyles of true urbanites. Durable and subtle for daily commuting and work, yet stylish for after hours, this is the ideal rainwear for all occasions.

53247 W WELSEY II TRENCH

USD \$200

- Sizes:** XS-XL
Fitting: Fitted
CB/Inseam: 89cm
- Insulation:** 5000mm
Water column: 5000mm
Weight:
- Fabric:**
 100% Polyester
- Colours:**
 469 Forest Night
 598 Navy
- Features:**
- HELLY TECH® Protection fabric
 - Waterproof, windproof and breathable
 - Fully seam sealed
 - Durable Water Repellency (DWR) treatment
 - Lined for comfort
 - Back yoke ventilation with mesh lining
 - YKK® front zipper with double breasted snap button closure on front
 - Two Hand pockets with YKK® zipper
 - Cuffs with YKK® zip adjustment
 - Adjustable hood that packs in collar
 - Removable tie belt for customized fit



62649 W ADEN INSULATED COAT

USD \$175

- Sizes:** XS-4XL
Fitting: Regular
CB/Inseam: 85cm
- Insulation:** 12510/4870
Water column: 12510/4870
Weight:
- Fabric:**
 Face: 100% Polyester / Back: 100% Polyurethane
- Colours:**
 001 White
 597 Navy
 662 Wild Rose
 990 Black
- Features:**
- Waterproof, windproof and breathable
 - 2-layer fabric construction
 - Fully seam sealed
 - Durable Water Repellency (DWR) treatment
 - 60gr Primaloft® Black Insulation
 - Fully insulated
 - 3/4 length
 - Packable hood
 - Lined for comfort
 - YKK® Coil zipped hand pockets
 - Interior pocket
 - Snap button sleeve adjustment



62648 WADEN LONG COAT

USD \$150

Sizes: XS-5XL
Fitting: Regular
CB/Inseam: 86cm

Insulation: 5000mm
Water column: 5000mm
Weight:

Fabric:
 Face: 100% Polyester / Back: 100% Polyurethane

Colours:
 001 White
 597 Navy
 990 Black

Features:

- HELLY TECH® Protection fabric
- Waterproof, windproof and breathable
- 2-layer construction
- Fully seam sealed
- Durable Water Repellency (DWR) treatment
- Lined for comfort
- Quick dry lining
- Packable hood
- Dual hand pockets with brushed lining
- Snap button sleeve adjustment



001



597



990

62650 WADEN JACKET

USD \$130

Sizes: XS-5XL
Fitting: Regular
CB/Inseam: 67.5cm

Insulation: 5000mm
Water column: 5000mm
Weight:

Fabric:
 100% Polyester

Colours:
 001 White
 597 Navy
 990 Black

Features:

- HELLY TECH® Protection fabric
- Waterproof, windproof and breathable
- 2-layer construction
- Fully seam sealed
- Durable Water Repellency (DWR) treatment
- Lined for comfort
- Quick dry lining
- Packable hood
- YKK® Coil zipped hand pockets
- Interior pocket
- Snap button sleeve adjustment
- Front plaque



001



597



990

62651 WADEN PANT

USD \$80

Sizes: XS-4XL
Fitting: Regular
CB/Inseam: 78cm

Insulation: 5000mm
Water column: 5000mm
Weight:

Fabric:
 Face: 100% Polyester / Back: 100% Polyurethane

Colours:
 990 Black

Features:

- HELLY TECH® Protection fabric
- Waterproof, windproof and breathable
- 2-layer construction
- Fully seam sealed
- Durable Water Repellency (DWR) treatment
- Lined for comfort
- Quick dry lining
- Elastic waist
- YKK® quality zippers
- HH® outline logo



990

53206 W SQUAMISH 2.0 CIS JACKET

USD \$225

Sizes: XS-XL
Fitting: Regular
CB/Inseam: 68cm

Insulation: 15400/21000
Water column: 15400/21000
Weight:

Fabric:
 Face: 100% Polyester / Back: 100% Polyurethane

Colours:
 597 Navy
 990 Black

Features:

- HELLY TECH® Protection
- Component Insulation System 3-in-1 Jacket
- Waterproof, windproof and breathable
- 2-layer fabric construction
- Fully seam sealed
- Durable Water Repellency (DWR) treatment
- Primaloft® Black Eco 80g insulation in liner
- Lined for comfort
- Quick dry lining
- Fixed hood



597



990



62066 W SEVEN J JACKET

USD \$100

Sizes: XS-3XL
Fitting: Regular
CB/Inseam: 68cm

Insulation: Water column: 5000mm
Weight:

Features:

- HELLY TECH® Protection fabric
- Waterproof, windproof and breathable
- 2-layer construction
- Fully seam sealed
- Durable Water Repellency (DWR) treatment
- Lined for comfort
- Quick dry lining
- Front storm flap
- YKK® front zipper
- YKK® zipped hand pockets
- Adjustable cuffs
- Bottom hem Cinch cord

Fabric:
 Face: 100% Polyester / Back: 100% Polyurethane

Colours:
 065 Raspberry
 597 Navy
 615 Bluebird
 992 Black



065



597



615



992

62381 W SEVEN J PANT

USD \$75

Sizes: XS-3XL
Fitting: Regular
CB/Inseam: 76cm

Insulation: Water column: 5000mm
Weight:

Features:

- HELLY TECH® Protection fabric
- Waterproof, windproof and breathable
- 2-layer construction
- Fully seam sealed
- Durable Water Repellency (DWR) treatment
- Lined for comfort
- Quick dry lining
- Elastic adjustable waist
- Bottom leg zip opening
- Articulated knees

Fabric:
 Face: 100% Polyester / Back: 100% Polyurethane

Colours:
 990 Black



990

53316 W MOSS INS COAT

USD \$180

Sizes: XS-XL
Fitting: Regular
CB/Inseam: 88cm

Insulation: Water column: 18860/0
Weight:

Features:

- Helox+® technology
- PU fabric construction
- Fully wind and waterproof
- Welded seams
- Snap out full pile lining for extra warmth, comfort and versatility
- Back yoke with ventilation holes underneath for extra comfort
- Front placket with hidden snap button closure and YKK® Vislon zipper down front
- Hanging hood with cord adjustment
- Hand pockets with welded flap and snap button closure

Fabric:
 Face: 100% Polyurethane / Back: 100% Polyester

Colours:
 344 Essential Yellow
 421 Lav Green
 597 Navy



344



421



597

53251 W MOSS RAIN COAT

USD \$110

Sizes: XS-XL
Fitting: Regular
CB/Inseam: 88cm

Insulation: Water column: 18860/0
Weight:

Features:

- HELOX+® technology
- PU fabric construction
- Fully wind and waterproof
- Welded seams
- Back yoke with ventilation holes underneath for extra comfort
- Front placket with hidden snap button closure and YKK® Vislon zipper down front
- Hanging hood with cord adjustment
- Hand pockets with welded flap and snap button closure
- Inside HELOX+® Technology print

Fabric:
 Face: 100% Polyester / Back: 100% Polyurethane

Colours:
 344 Essential Yellow
 597 Navy



344



597

53252 W KIRKWALL II RAINCOAT

USD \$125

Sizes: XS-XL
Fitting: Fitted
CB/Inseam: 87cm

Insulation: 18860/0
Water column: 18860/0
Weight:

Fabric:
 Face: 100% Polyurethane
 / Back: 100% Polyester

Colours:
 344 Essential Yellow
 598 Navy
 991 Black

Features:

- HELOX+® technology
- PU fabric construction
- Fully wind and waterproof
- Welded seams
- Back yoke with ventilation holes underneath for extra comfort
- Front placket with snap button closure
- Removable tie belt for customized fit
- Hand pockets with welded flap and snap button closure
- Bottom back pleat for extra movement
- Hanging hood with cord adjustment
- Adjustable cuffs



344



598



991

53253 W MOSS JACKET

USD \$65

Sizes: XS-XL
Fitting: Regular
CB/Inseam: 74cm

Insulation: 8280/443
Water column: 8280/443
Weight:

Fabric:
 Face: 100% Polyurethane
 / Back: 100% Polyester

Colours:
 344 Essential Yellow
 990 Black

Features:

- HELOX+® technology
- PU fabric construction
- Fully wind and waterproof
- Welded seams
- Front placket with hidden snap button closure and YKK® Vislon zipper down front
- Shock cord adjustment at hood
- Adjustable cuffs and bottom hem
- Two hand pockets with flap and rivets
- PU repair kit included
- Printed HH® logo on chest



344



990

53254 W MOSS PANT

USD \$40

Sizes: XS-XL
Fitting: Regular
CB/Inseam: 78cm

Insulation: 8280/443
Water column: 8280/443
Weight:

Fabric:
 Face: 100% Polyurethane
 / Back: 100% Polyester

Colours:
 990 Black

Features:

- HELOX+® technology
- PU fabric construction
- Fully wind and waterproof
- Welded seams
- Elasticated waist with draw cord adjustment
- Adjustable bottom hem
- PU repair kit included
- Printed HH® logo on hip



990



WOMEN'S WATERSPORT

33884 W AEGIR RACE JACKET

USD \$700

Sizes: XS-XL
Fitting: Regular
CB/Inseam: 80cm

Insulation: Water column: 25000mm
Weight:

Fabric: 100% Polyester

Colours: 222 Alert Red

- Features:**
- HELLY TECH® Professional fabric
 - 4-layer construction
 - Fully seam sealed
 - Durable Water Repellency (DWR) treatment
 - 3/4 Length
 - High collar
 - Fleece collar
 - Adjustable hood
 - EN471 Hi Vis
 - Double storm flap
 - YKK® zippers



222



AEGIR

Named after the Norse God of the ocean, the Aegir collection is designed for and developed with our professionals, with a racing mindset. Made for freedom of movements, the Aegir collection is light and agile, with 3-ply Hellytech® Professional fabric and an ergonomic collar and hood. The fabric is waterproof, breathable and windproof with fully sealed seams.

33885 W AEGIR RACE SALOPETTE

USD \$450

Sizes: XS-XL
Fitting: Regular
CB/Inseam: 82cm

Insulation: Water column: 25000mm
Weight:

Fabric: Face: 100% Polyamide / Back: 100% Polyurethane

Colours: 222 Alert Red
980 Ebony

- Features:**
- HELLY TECH® Professional fabric
 - 3-layer construction
 - Fully seam sealed
 - Durable Water Repellency (DWR) treatment
 - Reinforcement fabric on seat and knees
 - Over shoulder design for minimal bulk
 - YKK® two-way front zipper
 - Adjustable waist
 - Cargo pockets
 - Adjustable hem
 - Stealth cuff leg opening



222



980



34082 W ARCTIC OCEAN WINDPROOF PILE

USD \$160

Sizes: XS-XL
Fitting: Regular
CB/Inseam:

Insulation: Water column: **Weight:**

Fabric: 65% Polyester, 29% Viscose, 6% Elastane

Colours: 597 Navy
980 Ebony

- Features:**
- Classic Helly Hansen Pile
 - Windproof overlay and liner in body shoulders and front
 - YKK® Vislon® full zip in Center front
 - Chest pocket with YKK® zipper
 - Hand Warmer Pocket with YKK® zippers
 - Hypalon Hanger loop
 - Elastic binding at bottom Hem and sleeves
 - Arctic ocean badge on upper arm
 - HH Logo at chest
 - Helly Hansen Logo at back of collar



597



980

ARCTIC OCEAN SAILING

The Arctic Ocean Collection offers our best technologies to meet the challenges of the cold sea and shores. This collection has been designed with the insights for decades of sailing professionals operation on the cold waters and are made for both sailing and everyday life along the northern coasts and ocean.

34079 W ARCTIC OCEAN CHUNKY KNIT

USD \$150

Sizes: XS-XL
Fitting: Regular
CB/Inseam:

Insulation: Water column: **Weight:**

Fabric: Shell:

Colours: 034 Cream
217 Spice
597 Navy

- Features:**
- French Terry Cotton
 - Arctic Ocean Artwork print
 - Crew Neck Sweater
 - Bottom hem and sleeve rib



034



217



597



WOMEN'S WATERSPORT



33920 W SKAGEN OFFSHORE JACKET

USD \$350

- | | | |
|--|---|---------------------------|
| Sizes:
XS-XL | Fitting:
Regular | CB/Inseam:
74cm |
| Insulation: | Water column:
15000mm | Weight: |
| Fabric:
Face: 100%
Polyamide / Back:
100% Polyurethane | Features: | |
| Colours:
147 Cherry Tomato
597 Navy | <ul style="list-style-type: none"> • HELLY TECH® Performance fabric • Waterproof, windproof and breathable • 2-layer construction • Fully seam sealed • Durable Water Repellency (DWR) treatment • Quick dry Mesh lining • Lower back reinforcement • Adjustable hood • EN471 Hi Vis • Double storm flap • Profiled High collar • Fleece lining in collar | |



SAILING ESSENTIALS

The perfect balance between technical and lifestyle. This collection has been especially designed for the classic marine sailor with a cruising mindset. The 2ply HellyTech® Professional and Performance levels has solid and functional built, drawing experience from our professional line.

33921 W SKAGEN OFFSHORE BIB

USD \$250

- | | | |
|--|--|---------------------------|
| Sizes:
XS-XL | Fitting:
Regular | CB/Inseam:
83cm |
| Insulation: | Water column:
15000mm | Weight: |
| Fabric:
Face: 100%
Polyamide / Back:
100% Polyurethane | Features: | |
| Colours:
980 Ebony | <ul style="list-style-type: none"> • HELLY TECH® Performance fabric • Waterproof, windproof and breathable • 2-layer construction • Fully seam sealed • Durable Water Repellency (DWR) treatment • Quick dry Mesh lining • Quick dry inside • Reinforcement fabric on seat and knees • High back panel for protection • YKK® two-way front zipper • Adjustable suspenders • Adjustable waist | |



WOMEN'S WATERSPORT

34177 W PIER 3.0 JACKET

USD \$240

Sizes: XS-XL
Fitting: Regular
CB/Inseam: 72cm

Insulation: 15000mm
Water column: 15000mm
Weight:

Features:

- HELLY TECH® Performance fabric
- Waterproof, windproof and breathable
- Profiled High collar with
- Adjustable double cuff seals
- Fleece-lined hand warmer pockets

Fabric: 100% Polyamide

Colours: 222 Alert Red
597 Navy



33961 W PIER 3.0 BIB

USD \$160

Sizes: XS-XL
Fitting: Regular
CB/Inseam: 79cm

Insulation: 15000mm
Water column: 15000mm
Weight:

Features:

- HELLY TECH® Performance fabric
- Waterproof, windproof and breathable
- 2-layer construction
- Fully seam sealed
- Durable Water Repellency (DWR) treatment
- Mesh lining
- Quick dry inside
- Reinforcement fabric on seat and knees
- High back panel for protection
- Adjustable suspenders
- Adjustable waist
- YKK® two-way front zipper

Fabric: 96% Polyester, 4% Elastane

Colours: 597 Navy
980 Ebony



33998 W SALTRO JACKET

USD \$220

Sizes: XS-XL
Fitting: Regular
CB/Inseam: 72cm

Insulation: 15000mm
Water column: 15000mm
Weight:

Features:

- HELLY TECH® Performance fabric
- Waterproof, windproof and breathable
- Handwarmer pockets
- Fleece collar
- D-ring for Engine kill cord

Fabric: 100% Polyamide

Colours: 003 White
598 Navy
793 Redwood



34069 W HP RACING JACKET

USD \$200

Sizes: XS-XL
Fitting: Regular
CB/Inseam: 71,50cm

Insulation: 15000mm
Water column: 15000mm
Weight:

Features:

- HELLY TECH® Performance fabric
- Waterproof, windproof and breathable
- 2-layer construction
- Fully seam sealed
- Durable Water Repellency (DWR) treatment
- Lined for comfort
- Quick dry lining
- Hip length
- Dual hand pockets with brushed lining
- Adjustable cuffs
- Adjustable hem with drawcord
- Full stretch construction

Fabric: 74% cotton
19% polyamide
7%elastan

Colours: 001 White
597 Navy

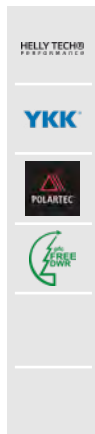

HYDROPOWER

Highly technical and modern, the Hydropower collection offers quality and function for high speed performance on water. Focusing on speed, aerodynamics and protection, this series features key technical marine functions. Its style and comfort are a tribute to the shared enjoyment of being in the water.

34070 W HP RACING MIDLAYER JACKET

USD \$225

Sizes: XS-XL
Fitting: Regular
CB/Inseam: 67cm

Insulation: 15000mm
Water column: 15000mm
Weight:

Fabric:
Face: 100% Polyester / Back: 100% Polyurethane

Colours:
597 Navy
793 Redwood
857 Pelican

- Features:**
- HELLY TECH® Performance fabric
 - Waterproof, windproof and breathable
 - 2-layer construction
 - Fully seam sealed
 - Durable Water Repellency (DWR) treatment
 - Lined for comfort
 - Quick dry lining
 - Hip length
 - LIFALOFT™ insulation
 - Dual hand pockets with brushed lining
 - Adjustable cuffs
 - Adjustable hem with drawcord

HELLY TECH®
PROTECTION

lifaLoft

YKK

FREE ZONE



597



793



857

30297 W CREW JACKET

USD \$155

CREW SERIES

Sizes: XS-5XL
Fitting: Regular
CB/Inseam: 67cm

Insulation: 5000mm
Water column: 5000mm
Weight:

Fabric:
100% Polyester

Colours:
002 White
222 Alert Red
317 Fire Cracker
598 Navy
853 Grey Fog

- Features:**
- HELLY TECH® Protection fabric
 - Waterproof, windproof and breathable
 - 2-layer construction
 - Fully seam sealed
 - Durable Water Repellency (DWR) treatment
 - Lined for comfort
 - Quick dry lining
 - Hip length
 - Adjustable cuffs
 - Pockets with zip

HELLY TECH®
PROTECTION



002



222



317



598



853

30317 W CREW MIDLAYER JACKET

USD \$165

Sizes: XS-5XL
Fitting: Regular
CB/Inseam: 67cm

Insulation: 5000mm
Water column: 5000mm
Weight:

Fabric:
Face: 100% Polyester / Back: 100% Polyurethane

Colours:
002 White
222 Alert Red
317 Fire Cracker
598 Navy
853 Grey Fog

- Features:**
- HELLY TECH® Protection fabric
 - Waterproof, windproof and breathable
 - 2-layer construction
 - Fully seam sealed
 - Durable Water Repellency (DWR) treatment
 - Lined for comfort
 - Fleece lining
 - Hip length
 - Insulated Polartec® 100g fleece lining
 - Dual hand pockets with brushed lining
 - Adjustable cuffs
 - Adjustable hem with drawcord

HELLY TECH®
PROTECTION

POLARTEC



317



222



002



598



853

33899 W CREW HOODED JACKET

USD \$165

Sizes: XS-3XL
Fitting: Regular
CB/Inseam: 67cm

Insulation: 5000mm
Water column: 5000mm
Weight:

Fabric:
Face: 100% Polyester / Back: 100% Polyurethane

Colours:
001 White
222 Alert Red
317 Fire Cracker
598 Navy
853 Grey Fog

- Features:**
- HELLY TECH® Protection fabric
 - Waterproof, windproof and breathable
 - 2-layer construction
 - Fully seam sealed
 - Durable Water Repellency (DWR) treatment
 - Mesh-lined for comfort
 - Polartec® fleece-lined comfortable collar
 - Hip length,
 - Chest pockets with zip
 - Hand pockets with zip
 - Stow away hood in collar

HELLY TECH®
PROTECTION

POLARTEC



001



222



317



598



853



33891 W CREW HOODED MIDLAYER JACKET

USD \$175

Sizes: XS-3XL
Fitting: Regular
CB/Inseam: 67cm

Insulation: 5000mm
Water column: 5000mm
Weight:

Fabric: Face: 100% Polyamide / Back: 100% Polyurethane

Colours: 001 White, 222 Alert Red, 317 Fire Cracker, 598 Navy, 853 Grey Fog

Features:

- HELLY TECH® Protection fabric
- Waterproof, windproof and breathable
- 2-layer construction
- Fully seam sealed
- Durable Water Repellency (DWR) treatment
- Polartec® fleece lining for additional warmth
- Polartec® fleece-lined comfortable collar
- Hip length,
- Chest pockets with zip
- Hand pockets with zip
- Stow away hood in collar



598



222

317

001

853

34145 W TEAM CREW MIDLAYER JACKET

USD \$165

Sizes: XS-5XL
Fitting: Regular
CB/Inseam: 67cm

Insulation: 5000mm
Water column: 5000mm
Weight:

Fabric: 100% polyester

Colours: 597 Navy

Features:

- HELLY TECH® Protection fabric
- Waterproof, windproof and breathable
- Adjustable bottom hem
- One hand Adjustable bottom hem
- Polartec® fleece-lined comfortable collar



597

30290 W CREW VEST

USD \$125

Sizes: XS-3XL
Fitting: Regular
CB/Inseam: 66cm

Insulation: 5000mm
Water column: 5000mm
Weight:

Fabric: 100 % Polyester

Colours: 001 White, 597 Navy, 853 Grey Fog

Features:

- HELLY TECH® Protection fabric
- Waterproof, windproof and breathable
- 2-layer construction
- Fully seam sealed
- Durable Water Repellency (DWR) treatment
- Hip length
- Chest pockets with zip
- Adjustable bottom hem



001



597



853

34071 W CREW INSULATOR JACKET

USD \$160

Sizes: XS-XL
Fitting: Regular
CB/Inseam: 66cm

Insulation: 5000mm
Water column: 5000mm
Weight:

Fabric: Face: 100% Polyester / Back: 100% Polyurethane

Colours: 598 Navy, 782 Canyon Red

Features:

- Wind resistant and water repellent polyester fabric
- Durable Water Repellency (DWR) treatment
- Primaloft® Black insulation
- YKK® Metalux front zipper
- Two Hand pockets with YKK® zipper
- Elasticated inside hem and collar for snug fit
- Printed HH® logo at sleeve and upper center back



598



782

34072 W CREW INSULATOR VEST

USD \$120

Sizes: XS-XL
Fitting: Regular
CB/Inseam: 66cm

Insulation:
Water column:
Weight:

Fabric:
 100% Polyester

Colours:
 598 Navy
 782 Canyon Red

Features:

- Wind resistant and water repellent polyester fabric
- Durable Water Repellency (DWR) treatment
- Primaloft® Black insulation
- YKK® Metalux front zipper
- Two Hand pockets with YKK® zipper
- Elasticated inside hem, armholes and collar for snug fit
- Printed HH® logo at upper center back



598



782

34143 W CREW SWEATSHIRT

USD \$65

Sizes: XS-XL
Fitting: Regular
CB/Inseam: 66cm

Insulation:
Water column:
Weight:

Fabric:
 100% Cotton

Colours:
 597 Navy

Features:

- French Terry Cotton
- HH® logo Print on sleeve
- Crew Neck Sweater
- Bottom hem and sleeve rib
- European Made



597

53055 W CREW PIQUE 2 POLO

USD \$45

Sizes: XS-3XL
Fitting: Regular
CB/Inseam: 66cm

Insulation:
Water column:
Weight:

Fabric:
 100% Polyester

Colours:
 001 White
 597 Navy

Features:

- Ribbed collar and cuffs
- Buttoned front placket
- HH® logo at sleeve



001



597

33984 W CREW TECH POLO

USD \$60

Sizes: XS-3XL
Fitting: Regular
CB/Inseam: 75cm

Insulation:
Water column:
Weight:

Fabric:
 100% Cotton

Colours:
 001 White
 597 Navy
 990 Black

Features:

- Quick Dry Tactel® waffle pique
- Buttoned front placket
- Rib collar and sleeve cuffs
- Side split
- Embroidered HH® logo on chest
- UPF rating30+



001



597



990



WOMEN'S WATERSPORT

53035 W NAIAD FLEECE JACKET

USD \$110

Sizes: XS-XL
Fitting: Regular
CB/Inseam: 65cm

Insulation:
Water column:
Weight:

Fabric:
 100% Polyester

Colours:
 217 Spice
 692 Evening Blue
 Stripe
 693 Evening Blue

- Features:**
- Polyester slick face fleece
 - Polyester micro lightweight rip stop fabric at collar
 - YKK® front zipper with back placket
 - Hand pockets with YKK® zipper
 - Elasticated inside hem and collar for snug fit
 - Embroidered HH® logo on sleeve and back collar

YKK



217



692

693

34081 W HP OCEAN SWT JACKET

USD \$130

Sizes: XS-XL
Fitting: Regular
CB/Inseam: 70cm

Insulation:
Water column:
Weight:

Fabric:
 65% Polyester,
 29% Viscose, 6%
 Elastane

Colours:
 793 Redwood
 949 Grey Melange
 990 Black

- Features:**
- Double side Jersey spacer knit
 - Lined hood
 - YKK® front zip
 - YKK® zippers in pockets
 - laminated detail at pockets
 - Raglan sleeve for freedom of movement
 - Hydropower Design Capsule details
 - Helly Hansen® silicone print at sleeve

YKK



793



949

990

34139 W SKAGEN LONG SLEEVE

USD \$55

Sizes: XS-XL
Fitting: Regular
CB/Inseam: 59cm

Insulation:
Water column:
Weight:

Fabric:
 100% Cotton

Colours:
 047 Snow
 597 Navy
 793 Redwood

- Features:**
- cotton waffle knit
 - long sleeves
 - rib at neck
 - rib at bottom rib and cuffs
 - HH logo



047



597

793

34140 W SIREN HOODIE

USD \$50

Sizes: XS-XL
Fitting: Regular
CB/Inseam: 60cm

Insulation:
Water column:
Weight:

Fabric:
 100% Polyester

Colours:
 597 Navy
 793 Redwood
 949 Grey Melange

- Features:**
- X-Cool quick dry fabric
 - Technical double knit polyester jersey
 - Hoodie silhouette
 - pull cord adjustment to bottom hem
 - HH® logo



597



793

949

34129 W SKAGEN KNIT

USD \$120

Sizes: XS-XL
Fitting: Regular
CB/Inseam: 61cm

Insulation:
Water column:
Weight:

Fabric:
 60% Cotton 30%
 Nylon 10% Merino

- Features:**
- Cotton and merino yarn blend
 - Shoulder button detail
 - Rib at bottom hem and cuffs
 - HH logo

Colours:
 034 Cream
 597 Navy
 793 Redwood



034



597



793

33945 W THALIA LS-SHIRT

USD \$50

Sizes: XS-XL
Fitting: Regular
CB/Inseam: 64cm

Insulation:
Water column:
Weight:

Fabric:
 Face: 100%
 Polyamide / Back:
 100% Polyurethane

- Features:**
- Wicking finish
 - Boat Neck and Loose fit sleeves
 - Woven fabric yoke
 - Printed HH® logo on bottom hem

Colours:
 002 White Navy
 Stripe
 598 Navy Melange



002



598

53057 W THALIA PANT

USD \$60

Sizes: XS-XL
Fitting: Regular
CB/Inseam: 73cm

Insulation:
Water column:
Weight:

Fabric:
 100% Cotton

- Features:**
- X-Cool
 - Elastic Waist
 - Hand pockets

Colours:
 596 Navy
 990 Black



596



990

33994 W HH LOGO FULL ZIP HOODIE

USD \$75

Sizes: XS-3XL
Fitting: Regular
CB/Inseam:

Insulation:
Water column:
Weight:

Fabric:
 100% Cotton

- Features:**
- Soft Cotton French terry
 - Fully zip
 - Helly Hansen® logo artwork on chest
 - Jersey lined hood
 - Hand pockets
 - Adjustable hood with drawcord
 - Ribbed hem and sleeve cuffs

Colours:
 597 Navy
 949 Grey Melange



597



949



WOMEN'S WATERSPORT

33978 W HH LOGO HOODIE

USD \$70

Sizes: XS-XL
Fitting: Regular
CB/Inseam: 64cm
Insulation:
Water column:
Weight:

Fabric: 100% Cotton
Features:
 • Soft Cotton French terry
 • Helly Hansen® logo artwork across chest
 • Jersey lined hood
 • Kangaroo pocket
 • Adjustable hood with drawcord
 • Ribbed hem and sleeve cuffs

Colours:
 001 White
 222 Alert Red
 597 Navy
 793 Redwood
 Melange
 950 Grey Melange



001



222



597



793



950

34112 W HH LOGO T-SHIRT

USD \$30

Sizes: XS-XL
Fitting: Regular
CB/Inseam: 64cm
Insulation:
Water column:
Weight:

Fabric: 65% Polyester, 29% Viscose, 6% Elastane
Features:
 • Classic fit T-shirt
 • Cotton single jersey
 • Helly Hansen® logo artwork across chest

Colours:
 001 White
 047 Snow
 222 Alert Red
 597 Navy
 783 Canyon Red
 Melange
 951 Grey Melange



047



951



001



222



597



783

34003 W HH LOGO CREW SWEAT

USD \$65

Sizes: XS-XL
Fitting: Regular
CB/Inseam: 66cm
Insulation:
Water column:
Weight:

Fabric: 100% Cotton
Features:
 • French Terry Cotton
 • HH® logo Print
 • Crew Neck Sweater
 • Bottom hem and sleeve rib
 • European Made

Colours:
 047 Snow
 222 Alert Red
 597 Navy
 793 Redwood
 Melange
 949 Grey Melange



793



222



597



047



949





JR KIDS



41720 JR FLY HIGH INS SKI SUIT

Sizes: 128/8,140/10,152/1
2,164/14,176/16,
Insulation: Excelloft LUX eco synthetic insulation 80gr
Fabric: Shell: 100% Polyester - Shell
2: 100% Polyamide - Lining: 100% Polyamide -
Insulation: 95% Recycled Polyester, 5% Polyester
Colours: 468 Olive Aop
597 Navy
673 Magenta Haze

Fitting: Regular
Water column: 25300/27710
Weight:

Features:

- SKI FREE
- Inside Life pocket™ engineered to preserve battery life
- RECCO® Advanced Rescue system Advanced rescue system
- Inside mesh stash/google pocket
- Inside elastic suspenders
- Extendable hem for 4cm extra leg length
- Ski pass pocket on sleeve
- Detachable and adjustable insulated hood
- Adjustable cuffs and bottom hem
- Boot gaiter and inner bottom leg in water repellent fabric for extra protection
- Reinforcement fabric on hem for extra protection and durability.

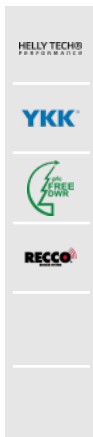

USD \$300



WINTERSPORTS

41689 JR CYCLONE JACKET

Sizes: 128/8,140/10,152/1
2,164/14,176/16,
Insulation: Primaloft® Black Eco 133g/m2 in side body/sleeves
Fabric: Face: 100% Polyester / Back: 100% Polyurethane
Colours: 470 Pine Green
599 Navy
983 Slate

Fitting: Regular
Water column: 25300/27710
Weight:

Features:

- Spray Tech
- Water repellent, windproof and breathable
- PFC free Water Repellency treatment
- Primaloft® Black Insulation 133g/m² in part of body and sleeve mixed with down feel high loft insulation in quilted panels front and back
- SKI FREE
- RECCO® Advanced Rescue system Advanced Rescue system
- Life pocket™
- Detachable and adjustable insulated hood
- Ski Pass pocket on sleeve
- Two hand pockets with side entry and YKK® zip closure



USD \$185



41681 JR DIAMOND JACKET

Sizes: 128/8,140/10,152/1
2,164/14,176/16,
Insulation: Primaloft® Black Eco 170g/m2 top of sleeves, 133g/m2 in side panels/ underarm and hood
Fabric: Face: 100% Polyester / Back: 100% Polyurethane
Colours: 001 White
598 Navy
657 Purple Potion

Fitting: Regular
Water column: 25300/27710
Weight:

Features:

- Spray Tech
- Water repellent, windproof and breathable
- PFC free Water Repellency treatment
- Primaloft® Black Insulation 170g/m² upper sleeve, 133g/m² at side panels, underarm and hood, mixed with down feel high loft insulation body front and back
- SKI FREE
- RECCO® Advanced Rescue system Advanced Rescue system
- Life pocket™
- Detachable and adjustable insulated hood
- Ski Pass pocket on sleeve
- Two hand pockets with side entry and YKK® zip closure



USD \$185



JUNIOR



41721 JR WHITEOUT JACKET

USD \$200

Sizes:
128/8,140/10,152/1
2,164/14,176/16,

Fitting:
Regular

CB/Inseam:
65cm

Insulation:
Primaloft® Black
Eco Insulation
133gr in jacket,
100gr in hood

Water column:
25300/27710

Weight:

Fabric:
Shell: 100%
Polyester - Lining:
100% Polyamide
- Lining: 100%
Polyester -
Insulation: 80%
Recycled Polyester,
20% Polyester

Features:

- SKI FREE
- Life pocket™ at chest
- Wrist gaiters for extra comfort and warmth
- Ski Pass pocket on sleeve
- Two hand pockets with side entry and YKK® zip closure
- Hi vis details
- Soft brushed tricot inside collar, chin guard and hand pockets for extra warmth and comfort
- Detachable and adjustable insulated hood
- Adjustable cuffs and bottom hem
- Adjustable and water repellent snap-up powder skirt

Colours:
300 Patrol Orange
538 Sonic Blue
597 Navy

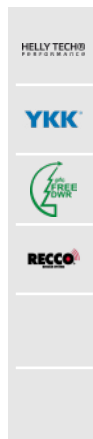

300



538



597

41722 JR SAPPHIRE JACKET

USD \$200

Sizes:
128/8,140/10,152/1
2,164/14,176/16,

Fitting:
Regular

CB/Inseam:
60cm

Insulation:
Excellt LUX eco
insulation 133gr
in jacket, 100gr in
hood and collar

Water column:
25300/27710

Weight:

Fabric:
Shell: 100%
Polyester - Lining:
100% Polyamide
- Lining: 100%
Polyester - Faux
fur: 85% Acrylic,
15% Polyester -
Insulation: 95%
Recycled Polyester,
5% Polyester

Features:

- SKI FREE
- Life pocket™ at inside chest
- Wrist gaiters for extra comfort and warmth
- Ski Pass pocket on sleeve
- Detachable Faux fur at hood
- Two hand pockets with side entry and YKK® zip closure
- Soft brushed tricot inside collar, lower back, chin guard and hand pockets for extra warmth and comfort
- Detachable and adjustable insulated hood
- Adjustable cuffs and bottom hem
- Adjustable and water repellent snap-up powder skirt
- Printed HH logos

Colours:
001 White
640 Ice Blue
673 Magenta Haze

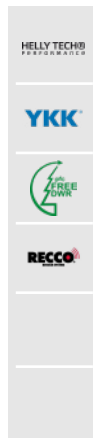

001



640



673

41723 JR TORNADO JACKET

USD \$175

Sizes:
128/8,140/10,152/1
2,164/14,176/16,

Fitting:
Regular

CB/Inseam:
61cm

Insulation:
Primaloft® Black
Eco Insulation
133gr in jacket,
100gr in hood

Water column:
25300/27710

Weight:

Fabric:
Shell: 100%
Polyester

Colours:
468 Olive Aop
538 Sonic Blue
597 Navy

Features:

- SKI FREE
- Life pocket™ at chest
- Ski Pass pocket on sleeve
- Two hand pockets with top entry and YKK® zip closure
- Soft brushed tricot inside collar, chin guard and hand pockets for extra warmth and comfort
- details for extra visibility and safety
- Detachable and adjustable insulated hood
- Adjustable cuffs and bottom hem
- Adjustable and water repellent snap-up powder skirt
- Printed HH logos



468



538



597

41724 JR SNOWANGEL JACKET

USD \$175

Sizes:
128/8,140/10,152/1
2,164/14,176/16,

Fitting:
Regular

CB/Inseam:

Insulation:
Primaloft® Black
Eco Insulation
133gr in jacket,
100gr in hood

Water column:
25300/27710

Weight:

Fabric:
Shell: 100%
Polyester

Colours:
213 Cayenne
640 Ice Blue
657 Purple Potion

Features:

- SKI FREE
- Life pocket™ at inside chest
- Ski Pass pocket on sleeve
- Two hand pockets with top entry and YKK® zip closure
- Soft brushed tricot inside collar, chin guard and hand pockets for extra warmth and comfort
- details for extra visibility and safety
- Detachable and adjustable insulated hood
- Adjustable cuffs and bottom hem
- Adjustable and water repellent snap-up powder skirt
- Printed HH logos



213



640



657

41726 JR BLAZE JACKET

USD \$165

Sizes:
128/8,140/10,152/1
2,164/14,176/16,

Fitting:
Regular

CB/Inseam:
64cm

Insulation:
Primaloft® Black
Eco Insulation
133gr in jacket,
100gr in hood and
inside sleeves

Water column:
17460

Weight:

Fabric:
Shell: 100%
Polyamide

Colours:
538 Sonic Blue
983 Slate

Features:

- Ski Pass pocket on sleeve
- Two hand pockets with side entry and YKK® zip closure
- Soft brushed tricot inside collar, chin guard and hand pockets for extra warmth and comfort
- details for extra visibility and safety
- Detachable and adjustable insulated hood
- Adjustable cuffs and bottom hem
- Attached water repellent powder skirt
- Printed HH logos



538



983

41727 JR DIVINE JACKET

USD \$165

Sizes:
128/8,140/10,152/1
2,164/14,176/16,

Fitting:
Fitted

CB/Inseam:
60cm

Insulation:
Primaloft® Black
Eco Insulation
133gr in body,
100gr in hood and
sleeves

Water column:
17460

Weight:

Fabric:
Shell: 100%
Polyamide - Lining:
100% Polyamide
- Insulation: 80%
Recycled Polyester,
20% Polyester

Colours:
001 White
640 Ice Blue
673 Magenta Haze

Features:

- Ski Pass pocket on sleeve
- Two hand pockets with side entry and YKK® zip closure
- Soft brushed tricot inside collar, chin guard and hand pockets for extra warmth and comfort
- details for extra visibility and safety
- Detachable and adjustable insulated hood
- Adjustable cuffs and bottom hem
- Attached water repellent powder skirt
- Printed HH logos



001



640



673

41740 JR SUMMIT BIB PANT

USD \$150

Sizes:
128/8,140/10,152/1
2,164/14,176/16,
Insulation:
Primaloft® Black
Eco 80gr insulation

Fitting: Regular
CB/Inseam: 62->66cm
Water column: 17460
Weight:

Fabric:
Shell: 100%
Polyamide

Colours:
001 White
470 Pine Green
597 Navy
657 Purple Potion
990 Black

- Features:**
- SKI FREE
 - Bib pant with adjustable elastic suspenders
 - Adjustable and partly elasticated waist with YKK® side zipper opening
 - Inner leg length system for perfect fit and length adjustment
 - Cargo pocket on thigh with fastener closure
 - Brushed tricot on inside seat area for extra warmth and comfort
 - Boot gaiter and inner bottom leg in water repellent fabric for extra protection
 - Boot gaiters with gripper elastic and boot hook

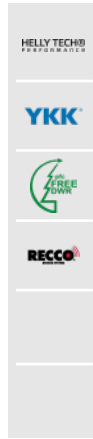

001

470

597

657

990

41729 JR NO LIMITS 2.0 PANT

USD \$140

Sizes:
128/8,140/10,152/1
2,164/14,176/16,
Insulation:
Primaloft®
Black Eco 100gr
insulation

Fitting: Regular
CB/Inseam: 62->66cm
Water column: 17460
Weight:

Fabric:
Shell: 100%
Polyester

Colours:
065 Raspberry
300 Patrol Orange
468 Olive Aop
597 Navy
640 Ice Blue
657 Purple Potion
Aop
990 Black

- Features:**
- SKI FREE
 - Detachable and adjustable elastic suspenders
 - Adjustable and partly elasticated waist with belt loops, zip fly, double buttons and hook
 - Inner leg length system for perfect fit and length adjustment
 - Hand pockets with YKK® zip closure
 - Brushed tricot on inside seat area for extra warmth and comfort
 - Boot gaiter and inner bottom leg in water repellent fabric for extra protection
 - Boot gaiters with gripper elastic and boot hook

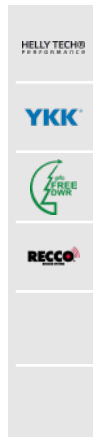

657

990



468

300

065

597

640

41606 JR LEGENDARY PANT

USD \$110

Sizes:
128/8,140/10,152/1
2,164/14,176/16,
Insulation:
Primaloft®
Black Eco 100gr
insulation

Fitting: Regular
CB/Inseam: 66cm
Water column: 17460
Weight:

Fabric:

Colours:

- Features:**
- HELLY TECH® Performance
 - Waterproof, windproof and breathable
 - Fully seam sealed
 - Boot gaiter and inner bottom leg in water repellent fabric for extra protection
 - Reinforcement fabric on hem for extra protection and durability.
 - Two hand pockets with YKK® zip closure
 - Gusset for freedom of movement
 - Articulation for great fit
 - Inner snow gaiters with gripper elastic and boot hook
 - Printed HH® logo on thigh

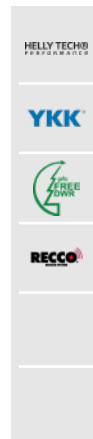

673

983

990



001

278

470

597

640

41683 JR LIFALOFT INS JACKET

USD \$140

Sizes:
128/8,140/10,152/1
2,164/14,176/16,
Insulation:

Fitting: Regular
CB/Inseam: 54cm
Water column: 17460
Weight:

Fabric:
100% Polyester

Colours:
001 White
598 Navy
640 Ice Blue
990 Black

- Features:**
- LIFALOFT™ insulation by Primaloft®
 - Fiber and down proof fabric construction
 - PFC Free DWR LIFALOFT™ insulation by Primaloft®
 - YKK® Center front zipper and dual YKK® zipped hand warmer pockets.
 - Full inner front zipper placket for wind protection.
 - Lycra edge band around collar and cuffs for clean finish
 - HH LIFALOFT™ logo at front left chest.



001

598

640

990



41733 JR INFINITY INSULATOR JACKET

USD \$130

Sizes:
128/8,140/10,152/1
2,164/14,176/16,

Fitting: Regular
CB/Inseam: 54cm
Water column:
Weight:

Insulation:
Down feel blowable
synthetic insulation

Fabric:
Shell: 100%
Polyester - Lining:
100% Polyester -
Insulation: 100%
Polyester

Colours:
065 Raspberry
343 Golden Glow
597 Navy
640 Ice Blue
673 Magenta Haze
990 Black

- Features:**
- Super lightweight polyester rip stop fabric
 - Blowable down feel synthetic insulation
 - Reversible with two different looks
 - YKK® front zipper
 - Two hand pockets with YKK® zip closure
 - Lycra edge bands on hood, hem and cuffs
 - Separate small bag for packing included
 - Printed HH logos

YKK



065



990



343



597



640



673

41612 JR ISFJORD DOWN MIX JACKET

USD \$190

Sizes:
128/8,140/10,152/1
2,164/14,176/16,

Fitting: Regular
CB/Inseam: 64cm
Water column:
Weight:

Insulation:

Fabric:
100% Polyester

Colours:
470 Pine Green
599 Navy
640 Ice Blue
673 Magenta Haze

- Features:**
- Micro lightweight polyester rip stop fabric
 - Durable Water Repellency (DWR) treatment
 - Allied® Down, 60/40, 480 FP in body and sleeves, 160gram
 - VX Comfort insulation in hood, shoulders, underarm and side panels
 - Detachable and adjustable hood
 - YKK® front zipper with back placket for extra protection
 - Printed HH logos



YKK



470



599



640



673

41730 JR URBAN PUFFY PARKA

USD \$200

Sizes:
128/8,140/10,152/1
2,164/14,176/16,

Fitting: Regular
CB/Inseam: 63cm
Water column: 27460/6480
Weight:

Insulation:
Sorona blowable
highloft synthetic
insulation

Fabric:
100% Polyamide

Colours:
300 Patrol Orange
482 Beluga
990 Black

- Features:**
- Waterproof durable polyamide ripstop outer fabric
 - Highloft synthetic insulation for extra warmth
 - Detachable hood with inner elastic gaiter and high collar for extra protection
 - Hand pockets with YKK® zip closure
 - Back tail drop
 - YKK® front zipper with storm flap for extra protection
 - Brushed tricot inside collar, at chin guard and in hand pockets for extra comfort and warmth
 - Printed HH logos

YKK



300



990



482

41731 JR LUCA PUFFY PARKA

USD \$200

Sizes:
128/8,140/10,152/1
2,164/14,176/16,

Fitting: Regular
CB/Inseam: 70cm

Insulation:
Sorona blowable
highloft synthetic
insulation

Water column: 15480/21180
Weight:

Fabric:
Shell: 100%
Polyamide - Lining:
100% Polyamide
- Insulation: 100%
Polyester

Features:

- Waterproof polyamide dobby weave outer fabric
- Highloft synthetic insulation for extra warmth
- Detachable hood with inner elastic gaiter and high collar for extra protection
- Double entry hand pockets with snap button closure on flaps
- Back tail drop
- YKK® front zipper with storm flap for extra protection
- Brushed tricot inside collar, at chin guard and in hand pockets for extra comfort and warmth

Colours:
217 Spice
857 Pelican
990 Black



217



990



857

41732 JR RADICAL PUFFY JACKET

USD \$170

Sizes:
128/8,140/10,152/1
2,164/14,176/16,

Fitting: Regular
CB/Inseam: 56cm

Insulation:
Recycled blowable
highloft synthetic
insulation

Water column: **Weight:**

Fabric:
Shell: 100%
Polyester - Lining:
100% Polyamide
- Insulation: 100%
Recycled Polyester

Features:

- Water repellent lightweight polyester ripstop outer fabric
- Highloft synthetic insulation for extra warmth
- Detachable hood with elastic gaiter and high collar for extra protection
- Elastic inside cuffs and hem
- Hand pockets with YKK® zip closure
- YKK® front zipper under storm flap
- Snap closure on storm flap
- Brushed tricot in hand pockets for extra comfort and warmth
- Printed HH logos

Colours:
343 Golden Glow
538 Sonic Blue
597 Navy
640 Ice Blue
673 Magenta Haze



343



538



597



640



673

41616 JR FELIX PARKA

USD \$180

Sizes:
128/8,140/10,152/1
2,164/14,176/16,

Fitting: Regular
CB/Inseam: 69cm

Insulation:
Primaloft® Black
Eco 200g/m2 in
body, 133g/m2 in
sleeves

Water column: 12510/4870
Weight:

Fabric:
Face: 100%
Polyester / Back:
100% Polyurethane

Features:

- HELLY TECH® Protection
- Waterproof, windproof and breathable
- Fully seam sealed
- Soft brushed tricot lining inside collar and chin guard for extra warmth and comfort
- Detachable and adjustable hood with removable Faux fur trimming
- Partly elasticated cuffs with snap adjustments
- Printed reflective HH logos

Colours:
482 Beluga
598 Navy



482



598



41685 JR MAYA PARKA

USD \$180

Sizes:
128/8,140/10,152/1
2,164/14,176/16,
Insulation:
Primaloft® Black
Eco 200g/m2 in
body, 133g/m2 in
sleeves

Fabric:
Face: 100%
Polyester / Back:
100% Polyurethane

Colours:
482 Beluga
597 Navy

Fitting: Regular
CB/Inseam: 74cm
Water column: 12510/4870
Weight:

- Features:**
- HELLY TECH® Protection
 - Waterproof, windproof and breathable
 - Fully seam sealed
 - Lined with soft pile in upper body, collar and hood for extra warmth and comfort
 - Soft brushed tricot lining inside collar and chin guard for extra warmth and comfort
 - Detachable and adjustable hood with pile lining
 - Partly elasticated waist
 - Double entry hand pockets with brushed tricot lining for extra warmth and safe storage for your belongings
 - Wrist gaiters for extra warmth and comfort

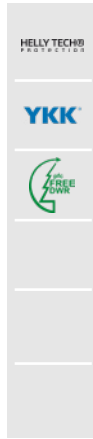

482



597

41735 JR URBAN RAIN JACKET

USD \$90

Sizes:
128/8,140/10,152/1
2,164/14,176/16,
Insulation:

Fabric:
Shell: 100%
Polyester - Lining:
100% Polyester

Colours:
597 Navy
640 Ice Blue
673 Magenta Haze
990 Black

Fitting: Regular
CB/Inseam: 58cm
Water column: 15930/5010
Weight:

- Features:**
- HELLY TECH® Protection
 - Quick dry mesh lining
 - Detachable and adjustable hood
 - Brushed tricot inside collar and chin guard
 - YKK® front zipper with storm flap for extra protection
 - Hand pockets with YKK® zip closure
 - Adjustable hem
 - Elasticated cuffs
 - Printed reflective HH logo



640

NO
CAD



673



990

40330 JR DUBLINER PANT

USD \$50

Sizes:
128/8,140/10,152/1
2,164/14,176/16,
Insulation:

Fabric:
100% Cotton

Colours:
990 Black

Fitting: Regular
CB/Inseam: 62cm
Water column: 5000mm
Weight:

- Features:**
- HELLY TECH® Protection fabric
 - Waterproof, windproof and breathable
 - Durable Water Repellency (DWR) treatment
 - Adjustable waist
 - Adjustable bottom of legs



990

41674 JR MOSS JACKET

USD \$50

Sizes:
128/8,140/10,152/1
2,164/14,176/16,
Insulation:

Fabric:
100% Polyester

Colours:
344 Essential
Yellow
990 Black

Fitting: Regular
CB/Inseam: 60cm
Water column: 8280/440
Weight:

- Features:**
- HELOX+® technology
 - Fully waterproof and windproof
 - Welded seams
 - Quick dry inside
 - Detachable hood
 - YKK® front zipper with storm flap for extra protection
 - Hand pockets with flap cover
 - Printed reflective HH® logo at chest



344



990

41675 JR MOSS PANT

USD \$25

Sizes:
128/8,140/10,152/1
2,164/14,176/16,

Fitting:
Regular

CB/Inseam:
65cm

Insulation:

Water column:
8280/440

Weight:

Fabric:
Face: 100%
Polyurethane
/ Back: 100%
Polyester
Colours:
990 Black

Features:

- HELOX+® technology
- Fully waterproof and windproof
- Welded seams
- Quick dry inside
- Elasticated and adjustable waist
- Adjustable bottom hem
- Printed reflective HH® logo on thigh



990

41736 JR CHAMP REVERISBLE JACKET

USD \$90

Sizes:
128/8,140/10,152/1
2,164/14,176/16,

Fitting:
Regular

CB/Inseam:
54cm

Insulation:

Water column:

Weight:

Fabric:
Shell: 100%
Polyester - Shell
2: 100% Polyester
- Shell 2: 100%
Polyester - Shell 2:
100% Polyester

Features:

- Reversible jacket with PFC free water repellent outer shell combined with soft, lightweight soft plush fleece on the other side
- Hand pockets both inside and outside
- YKK® Vislon quality front zipper
- Lycra edge band on cuffs and hem
- Chin guard for protection and comfort
- HH logo tab on pile side, printed HH logo on shell side

Colours:
343 Golden Glow
597 Navy
598 Navy Camo
640 Ice Blue
673 Magenta Haze



343



597



598



640



673

41737 JR CHAMP 1/2 ZIP MIDLAYER

USD \$70

Sizes:
128/8,140/10,152/1
2,164/14,176/16,

Fitting:
Regular

CB/Inseam:
56cm

Insulation:

Water column:

Weight:

Fabric:
Shell: 100%
Polyester - Shell:
100% Polyester
- Shell 2: 100%
Polyester

Features:

- Versatile 1/2 zip midlayer in lightweight soft plush fleece with lightweight woven fabric on yoke and collar
- YKK® Vislon quality zipper at neck
- Thumbhole at sleeves for secure fit
- Tail drop
- Chin guard for protection and comfort
- Printed HH logo at chest

Colours:
034 Cream
468 Olive Aop
538 Sonic Blue Aop
640 Ice Blue



034



468



538



640

41661 JR DAYBREAKER 2.0 JACKET

USD \$45

Sizes:
128/8,140/10,152/1
2,164/14,176/16,

Fitting:
Regular

CB/Inseam:
55cm

Insulation:

Water column:

Weight:

Fabric:
Face: 100%
Polyester / Back:
100% Polyurethane

Features:

- Polartec® recycled fleece
- YKK® zippers
- Raglan sleeves for freedom of movement
- Thumb holes at sleeve hem
- Chin guard for protection and comfort
- Embroidered HH® logo

Colours:
468 Olive
599 Navy
640 Ice Blue
673 Magenta Haze



468



599



640



673



41688 JR DAYBREAKER HOODIE

USD \$45

Sizes:
128/8,140/10,152/1
2,164/14,176/16,
Insulation:

Fitting:
Regular
Water column:

CB/Inseam:
55cm
Weight:

Features:

- Polartec® recycled fleece 100gr/m²
- Kangaroo pocket
- Raglan sleeves
- Flatlock seams for extra comfort
- Debossed large HH logo at chest

Fabric:
100% Polyester

Colours:
300 Patrol Orange
470 Pine Green
597 Navy
640 Ice Blue
673 Magenta Haze



300

470

597

640

673

41741 JR GRAPHIC HOODIE

USD \$45

Sizes:
128/8,140/10,152/1
2,164/14,176/16,
Insulation:

Fitting:
Regular
Water column:

CB/Inseam:
53cm
Weight:

Features:

- Cotton/polyester French terry fabric, 320 g/m²
- Hanging hood
- Double folded rib cuffs
- Double folded hem in self fabric
- Printed HH graphics at front and sleeve

Fabric:
80% Cotton, 20% Polyester

Colours:
001 White
470 Pine Green
597 Navy
640 Ice Blue
673 Magenta Haze
949 Grey Melange
990 Black



949

990



470

597

640

673

001

41742 JR GRAPHIC LS T-SHIRT

USD \$25

Sizes:
128/8,140/10,152/1
2,164/14,176/16,
Insulation:

Fitting:
Regular
Water column:

CB/Inseam:
51cm
Weight:

Features:

- Cotton/elastane single jersey 180g/m²
- Round neck self fabric
- Fold up hem and sleeve opening with double top stitch
- Printed HH graphic logos at front, back or sleeve

Fabric:
97% Cotton, 3% Elastane

Colours:
001 White
597 Navy
949 Grey Melange



597

001

949

41743 JR GRAPHIC T-SHIRT

USD \$22

Sizes:
128/8,140/10,152/1
2,164/14,176/16,
Insulation:

Fitting:
Regular
Water column:

CB/Inseam:
51cm
Weight:

Features:

- Cotton/elastane single jersey 180g/m²
- Round neck self fabric
- Fold up hem and sleeve opening with double top stitch
- Printed HH graphic logo at front/back

Fabric:
97% Cotton, 3% Elastane

Colours:
001 White
070 Ibis Rose
468 Olive
597 Navy
640 Ice Blue
949 Grey Melange



949



070



468



597



640

001

49403 JR LIFA MERINO MIDWEIGHT SET

USD \$100

Sizes:
128/8,140/10,152/1
2,164/14,176/16,

Fitting:
Regular

CB/Inseam:
54cm/61cm



Water column:

Weight:

Insulation:

Fabric:

Shell: 57%
Merino Wool, 43%
Polypropylene

Features:

- 2 layer construction
- 100% merino wool exterior combined with LIFA® technology interior
- Non itch
- Flatlock seams
- Elastic HH logo waistband
- HH logo label at shoulder seam
- 215g/m2 fabric weight

Colours:

065 Raspberry
470 Pine Green
538 Sonic Blue
597 Navy
598 Navy
673 Magenta Haze
949 Grey Melange
990 Black



673

NO
CAD



949



990



470



538



597



598

49311 JR HH MERINO MID SET

USD \$120

Sizes:
128/8,140/10,152/1
2,164/14,176/16,

Fitting:
Regular

CB/Inseam:
54cm/62cm

Insulation:

Water column:

Weight:

Fabric:

100% Merino Wool

Features:

- 100% Merino wool
- 19,5 micron
- Non Mulesed
- Flat lock stitches
- 195g/m2 fabric

Colours:

470 Pine Green
597 Navy
640 Ice Blue
673 Magenta Haze



470



597



640



673

41747 JR HH MERINO MID TOP

USD \$70

Sizes:
128/8,140/10,152/1
2,164/14,176/16,

Fitting:
Regular

CB/Inseam:
54cm

Insulation:

Water column:

Weight:

Fabric:

100% Merino Wool

Features:

- 100% Merino wool
- 19,5 micron
- Non Mulesed
- Flat lock stitches
- 195g/m2 fabric
- Raglan sleeves
- HH logo tab at shoulder seam

Colours:

470 Pine Green
597 Navy
640 Ice Blue
949 Grey Melange



470



597



640



949

41748 JR HH MERINO MID BOTTOMS

USD \$50

Sizes:
128/8,140/10,152/1
2,164/14,176/16,

Fitting:
Regular

CB/Inseam:
62cm

Insulation:

Water column:

Weight:

Fabric:

100% Merino Wool

Features:

- 100% Merino wool
- 19,5 micron
- Non Mulesed
- Flat lock stitches
- 195g/m2 fabric
- HH logo tab at waist

Colours:

470 Pine Green
597 Navy
640 Ice Blue
949 Grey Melange



470



597



640



949



48647 JR HH LIFA ACTIVE SET

USD \$80

Sizes:
128/8,140/10,152/1
2,164/14,176/16,

Fitting: Relaxed
CB/Inseam: 55cm/63cm
Water column: **Weight:**

Insulation:

Fabric:
65% Polyester, 35%
Polypropylene

Colours:
065 Raspberry
597 Navy
640 Ice Blue
990 Black

Features:

- Lightweight insulation
- LIFA® Flow technology enables maximum moisture management
- 2 layer construction with LIFA® fibers inside and wicking technical fibers outside
- Flat lock seams for max comfort
- 130g/m2 fabric



065



597



640



990

26665 JR HH LIFA SET

USD \$70

Sizes:
128/8,140/10,152/1
2,164/14,176/16,

Fitting: Regular
CB/Inseam: 55cm/63cm
Water column: **Weight:**

Insulation:

Fabric:
100%
Polypropylene

Colours:
998 Black

Features:

- Lightweight insulation
- 100% LIFA®
- Flat lock seams for max comfort
- Natural stretch fabric
- 125g/m2 fabric



998



40470 K TINDEN SKISUIT

USD \$220

WINTERSPORTS

Sizes:
86/1,92/2,98/3,104/
4,110/5,116/6,122/7
,128/8,134/9,

Fitting:
Regular

CB/Inseam:
39->42.5cm

Water column: **Weight:**

Insulation:
Excelloft LUX
eco synthetic
insulation, 200gr
in seat, 170gr in
body, sleeves, legs,
100gr in hood and
collar

- Features:**
- Adjustable length for both sleeves and legs to grow with the kid
 - areas for extra visibility
 - 360 degrees reflectivity
 - Reinforcement fabric knees and bottom of legs
 - No back seam seat construction with reinforcement fabric for extra waterproofness and durability
 - Detachable and partly elasticated hood
 - Adjustable bottom legs
 - Elasticated cuffs
 - YKK® front zipper with backflap for extra protection

Fabric:
80% Cotton, 20%
Polyester

Colours:
597 Navy
673 Magenta Haze



597



673

Kids are our true professionals, testing our gear in the toughest environments

40473 K TINDEN INS JACKET

USD \$160

Sizes:
86/1,92/2,98/3,104/
4,110/5,116/6,122/7
,128/8,134/9,

Fitting:
Regular

CB/Inseam:
47cm

Water column: **Weight:**

Insulation:
Excelloft LUX
synthetic
insulation, 170gr
in jacket, 100gr in
hood and collar

- Features:**
- HELLY TECH® Performance
 - areas for extra visibility
 - Soft brushed tricot lining inside collar and chin guard for extra warmth and comfort
 - Elasticated cuffs
 - YKK® Vislon front zipper with back placket for extra protection
 - Two hand pockets with fastener closure
 - Articulated sleeves
 - Adjustable and water repellant snap-up powder skirt with gripper elastic
 - Reflective piping and HH® logos

Fabric:
Shell: 100%
Polyamide - Lining:
100% Polyamide
- Insulation: 95%
Recycled Polyester,
5% Polyester

Colours:
597 Navy
673 Magenta Haze



597



673

40393 K RIDER 2 INS JACKET

USD \$130

Sizes:
86/1,92/2,98/3,104/
4,110/5,116/6,122/7
,128/8,134/9,140/10
,152/12,

Fitting:
Regular

CB/Inseam:
48cm

Water column: **Weight:**
17460

Insulation:
Primaloft® Black
Eco Insulation
133gr in jacket,
100gr in hood

- Features:**
- HELLY TECH® Performance
 - Waterproof, windproof and breathable
 - Fully seam sealed
 - Hi vis fabric on hood and sleeves
 - Soft brushed tricot lining inside collar and chin guard for extra warmth and comfort
 - Elasticated cuffs and partly elasticated bottom hem
 - YKK® Vislon front zipper with back placket for extra protection
 - Two hand pockets with YKK® zip closure
 - Articulated sleeves
 - Reflective piping and HH® logos

Fabric:
Face: 100%
Polyamide / Back:
100% Polyurethane

Colours:
065 Raspberry
538 Sonic Blue
597 Navy
673 Magenta Haze



597



538



065



673

KIDS



40374 K LEGEND INS JACKET

USD \$120

Sizes:
86/1,92/2,98/3,104/
4,110/5,116/6,122/7
,128/8,134/9,140/10
,152/12,

Insulation:
Primaloft® Black
Eco Insulation
133gr in jacket,
100gr in hood

Fabric:
Face: 100%
Polyamide / Back:
100% Polyurethane

Colours:
070 Ibis Rose
097 Bubblegum
Pink Aop
213 Cayenne
468 Olive Aop
538 Sonic Blue
597 Navy

Fitting:
Regular

CB/Inseam:
48cm

Water column:
14770/20490

Weight:

Features:

- HELLY TECH® Performance
- Waterproof, windproof and breathable
- Fully seam sealed
- Hi vis fabric on hood brim
- Soft brushed tricot lining inside collar and chin guard for extra warmth and comfort
- Adjustable cuffs and partly elasticated bottom hem
- YKK® front zipper with back placket for extra protection
- Two hand pockets with YKK® zip closure
- Articulated sleeves
- Printed reflective HH logos



070



597



097



213



468



538

40366 K VERTICAL INS BIB PANT

USD \$110

Sizes:
86/1,92/2,98/3,104/
4,110/5,116/6,122/7
,128/8,134/9,

Insulation:
Primaloft® Black
Eco Insulation 80gr

Fabric:
Face: 100%
Polyester / Back:
100% Polyurethane

Colours:
065 Raspberry
097 Bubblegum
Pink Aop
468 Olive Aop
598 Navy

Fitting:
Regular

CB/Inseam:
40->44cm

Water column:

Weight:

Features:

- HELLY TECH® Performance
- Waterproof, windproof and breathable
- Fully seam sealed
- Upper body in Polartec 100g/m² fleece
- Primaloft® Black Eco insulation, 80g/m² in pant part
- Adjustable leg length solution for customized fit
- Shoulder adjustment on bib for perfect fit
- YKK® front zipper on bib
- Reinforcement fabric on seat, knees and bottom legs
- Boot gaiter and inner bottom leg in water repellent fabric for extra protection

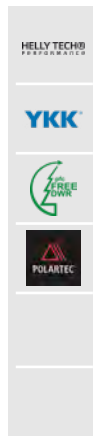

468



097



065



598

40342 K RIDER 2 INS BIB

USD \$100

Sizes:
86/1,92/2,98/3,104/
4,110/5,116/6,122/7
,128/8,134/9,140/10
,152/12,

Fitting:
Regular

CB/Inseam:
42->45cm

Water column:
17460

Weight:

Insulation:
Primaloft® Black
Eco Insulation
100gr

Fabric:

Colours:
162 Red
278 Neon Orange
470 Pine Green
538 Sonic Blue
597 Navy
657 Purple Potion
990 Black

Features:

- HELLY TECH® Performance
- Waterproof, windproof and breathable
- Fully seam sealed
- Adjustable leg length
- Reinforcement fabric on seat, knees and bottom legs
- Boot gaiter and inner bottom leg in water repellent fabric for extra protection
- Adjustable bottom leg tab w/fastener
- Adjustable elastic suspenders
- Elasticated waist at back
- Boot gaiter with rubber strap for secure fit
- Articulated knees
- Printed reflective HH logo



40477 K OSLO PARKA

USD \$160

Sizes:
86/1,92/2,98/3,104/
4,110/5,116/6,122/7
,128/8,134/9,140/10
,152/12,

Fitting:
Regular

CB/Inseam:
51cm

Water column:
6160/8510

Weight:

Insulation:
Sorona blowable
highloft synthetic
insulation

Fabric:
Shell: 100%
Polyamide

Colours:
343 Golden Glow
470 Pine Green
597 Navy
657 Purple Potion

Features:

- HELLY TECH® Protection
- Highloft synthetic insulation for extra warmth
- Detachable reflective faux fur for extra comfort and safety
- Detachable hood
- Double entry hand pockets with fastener closure under flaps
- YKK® front zipper with storm flap for extra protection
- Snap button fastening on storm flap
- Brushed tricot inside collar, at chin guard and in hand pockets for extra comfort and warmth



40478 K VIKA PUFFY JACKET

USD \$140

Sizes:
86/1,92/2,98/3,104/
4,110/5,116/6,122/7
,128/8,134/9,

Fitting:
Regular

CB/Inseam:
48cm

Water column:

Weight:

Insulation:
Recycled blowable
highloft synthetic
insulation

Fabric:
Shell: 100%
Polyester

Colours:
343 Golden Glow
538 Sonic Blue
597 Navy
640 Ice Blue
673 Magenta Haze

Features:

- Water repellent lightweight polyester ripstop outer fabric
- Highloft synthetic insulation for extra warmth
- Detachable hood with elastic in sides and high collar for extra protection
- Elastic inside cuffs and hem
- Hand pockets with YKK® zip closure
- YKK® front zipper under storm flap
- Snap closure on storm flap
- Brushed tricot in hand pockets for extra comfort and warmth
- Printed HH logos



40379 K SHELTER JACKET

USD \$100

- Sizes:** 86/1,92/2,98/3,104/4,110/5,116/6,122/7,128/8,134/9,140/10,152/12,
Fitting: Regular
CB/Inseam: 46cm
Water column: 15000mm
Weight:
Insulation:
Fabric: 100% Polyamide
Colours: 065 Raspberry, 468 Olive, 538 Sonic Blue, 673 Magenta Haze
- Features:**
- HELLY TECH® Performance fabric
 - Waterproof, windproof and breathable
 - Fully seam sealed
 - Durable Water Repellency (DWR) treatment
 - Lined for comfort
 - Quick dry lining
 - Hi vis/neon hood for extra visibility
 - Brushed tricot inside collar and chin guard
 - Detachable and partly elasticated hood
 - YKK® front zip closure with back storm flap
 - Hand pockets with YKK® zipper



468



065

538

673

41026 K SHELTER PANT

USD \$55

- Sizes:** 86/1,92/2,98/3,104/4,110/5,116/6,122/7,128/8,134/9,140/10,152/12,
Fitting: Regular
CB/Inseam: 44cm
Water column: 15000mm
Weight:
Insulation:
Fabric: 100% Polyamide
Colours: 065 Raspberry, 597 Navy, 980 Ebony
- Features:**
- HELLY TECH® Performance fabric
 - Waterproof, windproof and breathable
 - 2-layer construction
 - Fully seam sealed
 - Durable Water Repellency (DWR) treatment
 - Lined for comfort
 - Quick dry lining
 - Articulated knees
 - Elastic waist
 - Reflective elements
 - Reinforced seat and knee



065



597



980

40384 K MOSS PU RAINSET

USD \$90

- Sizes:** 86/1,92/2,98/3,104/4,110/5,116/6,122/7,128/8,134/9,
Fitting: Regular
CB/Inseam: 45/41cm
Water column: 25000/460
Weight:
Insulation:
Fabric: Face: 100% Polyamide / Back: 100% Polyurethane
Colours: 344 Essential Yellow
- Features:**
- HELOX+® technology
 - Fully waterproof and windproof
 - PU fabric construction
 - Welded seams
 - Quick dry inside
 - Water repellent fabric on inner cuffs and bottom of legs for extra protection
 - Detachable and elasticated hood
 - YKK® front zipper with storm flap for extra protection
 - Elasticated hem, cuffs and hood for snug fit
 - Partly elasticated waist on bib
 - Elastic suspenders with adjustment possibilities



344

40360 K BERGEN PU RAINSET

USD \$75

- Sizes:** 86/1,92/2,98/3,104/4,110/5,116/6,122/7,128/8,134/9,
Fitting: Regular
CB/Inseam: 46cm
Water column: 21270/870
Weight:
Insulation:
Fabric: 100% Polyurethane
Colours: 162 Red, 470 Pine Green, 538 Sonic Blue, 673 Magenta Haze
- Features:**
- HELOX+® technology
 - Fully wind and waterproof
 - PU fabric construction
 - Welded seams
 - Quick dry inside
 - Detachable and elasticated hood
 - YKK® front zipper with storm flap for extra protection
 - Reflective elements
 - Adjustable suspenders
 - Elastic rubber band under foot for secure fit
 - Elastic cuffs and leg opening
 - Printed reflective HH® logo



470



162



538



673



40479 K STORM REVERSIBLE INSULATOR

USD \$100

Sizes: 86/1,92/2,98/3,104/4,110/5,116/6,122/7,128/8,134/9,
Fitting: Regular
CB/Inseam: 44cm
Water column:
Weight:
Insulation: Down feel blowable synthetic insulation
Features:
 • Super lightweight polyester rip stop fabric
 • Blowable down feel synthetic insulation
 • Reversible with two different looks
Fabric:
 Shell: 100% Polyester - Lining: 100% Polyester - Insulation: 100% Polyester
Colours:
 065 Raspberry
 097 Bubbelgum Pink
 343 Golden Glow
 597 Navy



40481 K CHAMP REVERSIBLE JACKET

USD \$80

Sizes: 86/1,92/2,98/3,104/4,110/5,116/6,122/7,128/8,134/9,
Fitting: Regular
CB/Inseam: 46cm
Water column:
Weight:
Insulation:
Fabric:
 Shell: 100% Polyester - Shell 2: 100% Polyester - Shell 2: 100% Polyester - Shell 2: 100% Polyester
Features:
 • Reversible jacket with PFC free water repellent outer shell combined with soft, lightweight soft plush fleece on the other side
 • Hand pockets both inside and outside
 • YKK® Vislon quality front zipper
 • Lycra edge band on cuffs and hem
 • Chin guard for protection and comfort
 • HH logo tab on pile side, printed HH logo on shell side
Colours:
 343 Golden Glow
 597 Navy
 598 Navy Camo
 640 Ice Blue
 673 Magenta Haze



40482 K CHAMP 1/2 ZIP MIDLAYER

USD \$50

Sizes: 86/1,92/2,98/3,104/4,110/5,116/6,122/7,128/8,134/9,
Fitting: Regular
CB/Inseam: 47cm
Water column:
Weight:
Insulation:
Fabric:
 Shell: 100% Polyester - Shell: 100% Polyester - Shell: 100% Polyester - Shell 2: 100% Polyester
Features:
 • Versatile 1/2 zip midlayer in lightweight soft plush fleece with lightweight woven fabric on yoke and collar
 • YKK® Vislon quality zipper at neck
 • Thumbhole at sleeves for secure fit
 • Lycra edge band at hem and cuffs
 • Chin guard for protection and comfort
 • Printed HH logo at chest
Colours:
 034 Cream
 097 Bubbelgum
 Pink Aop
 468 Olive Aop
 538 Sonic Blue Aop
 640 Ice Blue



40362 K DAYBREAKER 2.0 JACKET

USD \$45

Sizes: 86/1,92/2,98/3,104/4,110/5,116/6,122/7,128/8,134/9,
Fitting: Regular
CB/Inseam: 45cm
Water column:
Weight:
Insulation:
Fabric:
 Face: 100% Polyurethane / Back: 100% Polyester
Features:
 • Polartec® recycled fleece
 • YKK® quality front zipper
 • Raglan sleeves for freedom of movement
 • Thumb holes at sleeve hem
 • Chin guard for protection and comfort
 • Embroidered HH® logo
Colours:
 070 Ibis Rose
 599 Navy
 640 Ice Blue
 983 Slate



NO CAD

983 599 640 070

40483 K DAYBREAKER HOODIE

USD \$40

Sizes: 86/1,92/2,98/3,104/
4,110/5,116/6,122/7
,128/8,134/9,
Insulation:

Fabric:
100% Recycled
Polyester

Colours:
097 Bubbelgum
Pink Aop
468 Olive Aop
538 Sonic Blue
597 Navy
640 Ice Blue
673 Magenta Haze

Fitting: Regular **CB/Inseam:** 44cm
Water column: **Weight:**
Features:
• Polartec recycled 100gr/m² fleece
• Raglan sleeves
• Flatlock seams for extra comfort
• Embroidered HH logo at chest



41084 K DAYBREAKER FLEECE PANT

USD \$30

Sizes: 86/1,92/2,98/3,104/
4,110/5,116/6,122/7
,128/8,134/9,
Insulation:

Fabric:
100% Polyester

Colours:
097 Bubbelgum
Pink Aop
468 Olive Aop
597 Navy
673 Magenta Haze

Fitting: Regular **CB/Inseam:** 41cm
Water column: **Weight:**
Features:
• Polartec® recycled 100g fleece
• Elasticated waist
• Elasticated bottom hem
• Embroidered HH logo on leg



48610 K HH LIFA MERINO SET

USD \$75

Sizes: 86/1,92/2,98/3,104/
4,110/5,116/6,122/7
,128/8,134/9,
Insulation:

Fabric:
57% Merino Wool,
43% Polypropylene

Colours:
065 Raspberry
097 Bubbelgum Pink
470 Pine Green
538 Sonic Blue
597 Navy
640 Ice Blue
673 Magenta Haze
952 Grey Melange

Fitting: Regular **CB/Inseam:** 44/37cm
Water column: **Weight:**
Features:
• 2-layer construction
• 100% Merino wool exterior combined with LIFA® technology interior
• Fleece reinforcement on knees and elbows
• Non itch
• Flat lock seams
• 215g/m² fabric



49312 K HH MERINO MID SET

USD \$100

Sizes: 86/1,92/2,98/3,104/
4,110/5,116/6,122/7
,128/8,134/9,
Insulation:

Fabric:
100% Merino Wool

Colours:
470 Pine Green
640 Ice Blue
673 Magenta Haze
951 Grey Melange

Fitting: Regular **CB/Inseam:** 44/39cm
Water column: **Weight:**
Features:
• 100% Merino wool
• 19,5 micron
• Non Mulesed
• Flat lock stitches
• 195g/m² fabric



40493 K HH MERINO MID TOP

USD \$55

Sizes: 80/0-1,86/1,92/2,98/3,104/4,110/5,116/6,122/7,128/8,134/9,140/10,146/11,152/12,
Fitting: Regular
CB/Inseam: 44cm
Water column:
Weight:

Insulation:
Fabric: 100% Merino Wool
Colours: 470 Pine Green, 640 Ice Blue, 673 Magenta Haze, 950 Grey Melange

Features:
 • 100% Merino wool
 • 19,5 micron
 • Non Mulesed
 • Flat lock stitches
 • 195g/m2 fabric



470



640

673

950

40494 K HH MERINO MID BOTTOMS

USD \$45

Sizes: 80/0-1,86/1,92/2,98/3,104/4,110/5,116/6,122/7,128/8,134/9,140/10,146/11,152/12,
Fitting: Regular
CB/Inseam: 39cm
Water column:
Weight:

Insulation:
Fabric: 100% Merino Wool
Colours: 470 Pine Green, 640 Ice Blue, 673 Magenta Haze, 950 Grey Melange

Features:
 • 100% Merino wool
 • 19,5 micron
 • Non Mulesed
 • Flat lock stitches
 • 195g/m2 fabric



470



640

673

950

67162 K OUTLINE BEANIE

USD \$20

Sizes: 49/50,53/54,57/58,
Fitting: Fitted
CB/Inseam:
Insulation:
Water column:
Weight:

Fabric: 95% Acrylic, 4% Polyamide, 1% Elastane
Features:
 • 100% Acrylic knit
 • Knitted HH logo

Colours: 070 Ibis Rose, 470 Pine Green, 597 Navy, 640 Ice Blue



070



470

597

640

67428 K MERINO BEANIE

USD \$30

Sizes: 49/50,53/54,57/58,
Fitting: Regular
CB/Inseam:
Insulation:
Water column:
Weight:

Fabric: 100% Merino Wool
Features:
 • 100% Merino Wool

Colours: 597 Navy, 673 Magenta Haze



597



673



ACCESSORIES



ACCES- SORIES



ACCESSORIES

57502 BRAND BEANIE

USD \$22

HATS & BEANIES

Sizes: STD
Fitting: Fitted
CB/Inseam:
Insulation:
Water column:
Weight:

Fabric: 95% Acrylic, 4% Polyamide, 1% Elastane
Features:
 • Jersey Knit
 • Circular knit, plaited with elastane for good stretch and recovery
 • Embroidered Logo

Colours:
 001 White
 039 Festival Fuchsia
 421 Lav Green
 597 Navy
 639 Electric Blue
 990 Black

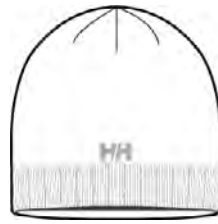

001



990



039



421



597



639

67147 OUTLINE BEANIE

USD \$25

Sizes: STD
Fitting: Fitted
CB/Inseam:
Insulation:
Water column:
Weight:

Fabric: 95% Acrylic, 4% Polyamide, 1% Elastane
Features:
 • Jersey Knit
 • Circular knit, plaited with elastane for good stretch and recovery

Colours:
 001 White
 213 Cayenne
 482 Beluga
 597 Navy
 603 North Sea Blue
 639 Electric Blue
 990 Black



639



001



990



213



482



597



603

67149 OUTLINE REVERSIBLE BEANIE

USD \$30

Sizes: STD
Fitting: Fitted
CB/Inseam:
Insulation:
Water column:
Weight:

Fabric: 100% Acrylic
Features:
 • 1 x 1 Rib Knit
 • Debossed Logos
 • Reversible

Colours:
 639 Electric Blue
 990 Black



639



990

67148 OUTLINE HEADBAND

USD \$25

Sizes: STD
Fitting: Fitted
CB/Inseam:
Insulation:
Water column:
Weight:

Fabric: 95% Acrylic, 4% Polyamide, 1% Elastane
Features:
 • Jersey Knit
 • Circular knit, plaited with elastane for good stretch and recovery

Colours:
 213 Cayenne
 990 Black



213



990

ACCESSORIES



67150 RIDGELINE BEANIE

USD \$35

Sizes: STD Fitting: Fitted CB/Inseam:

Insulation: Water column: Weight:

Fabric: 95% Acrylic, 4% Polyamide, 1% Elastane
 Features:
 • Jersey Knit Circular knit
 • Plaited with elastane for good stretch and recovery
 • Fixed pom-pom

Colours:
 034 Cream
 421 Lav Green
 597 Navy
 639 Electric Blue
 662 Wild Rose
 994 Graphite Blue



662



994



034



421



597



639

67404 TRAVERSE BEANIE

USD \$25

Sizes: STD Fitting: Regular CB/Inseam:

Insulation: Water column: Weight:

Fabric: 100% Acrylic
 Features:
 • Slouch knit beanie
 • Relaxed fit

Colours:
 065 Raspberry
 421 Lav Green
 639 Electric Blue
 990 Black



065



421



639



990

ACCESSORIES

67453 SEA GEAR BEANIE

USD \$30

Sizes: STD Fitting: Regular CB/Inseam:
 Insulation: Water column: Weight:

Fabric: 100% Acrylic
 Features:
 • Waffle knit
 • Sea Gear logo

Colours:
 597 Navy
 990 Black



597



990

67450 COZY BEANIE

USD \$30

Sizes: STD Fitting: Regular CB/Inseam:
 Insulation: Water column: Weight:

Fabric: 58% Acrylic, 22% Cotton, 12% Polyamide, 7% Polyester, 1% Elastane
 Features:
 • Knitted Beanie
 • Extra soft
 • Regular fit

Colours:
 597 Navy
 662 Wild Rose
 853 Grey Fog



597



662



853

67448 FLAG BEANIE

USD \$30

Sizes: STD Fitting: Regular CB/Inseam:
 Insulation: Water column: Weight:

Fabric: 100% Acrylic
 Features:
 • Embroidered flags, Ribbed cuff

Colours:
 011 Off White
 597 Navy



597



011

67083 MOUNTAIN BEANIE FLEECE LINED

USD \$25

Sizes: STD Fitting: Fitted CB/Inseam:
 Insulation: Water column: Weight:

Fabric: Shell : 100% Acrylic, Lining : 100% Polyester
 Features:
 • Classic fit, all purpose beanie
 • Inner brushed fleece lining for extra warmth

Colours:
 983 Slate
 991 Black / Grey



983



991

67405 CHILL KNIT BEANIE

USD \$30

Sizes: STD Fitting: Relaxed CB/Inseam:
 Insulation: Water column: Weight:

Fabric: 100% Acrylic Features:
 • Knitted beanie
 • Relaxed fit

Colours:
 013 Off White
 597 Navy
 990 Black



597



013



990

67154 URBAN CUFF BEANIE

USD \$30

Sizes: STD Fitting: Fitted CB/Inseam:
 Insulation: Water column: Weight:

Fabric: 100% Acrylic Features:
 • Seamless 1x1 rib, large rib cuff

Colours:
 421 Lav Green
 597 Navy
 662 Wild Rose
 990 Black



990



421



597



662

67809 HH WINTER BEANIE

USD \$30

Sizes: STD Fitting: Fitted CB/Inseam:
 Insulation: Water column: Weight:

Fabric: 95% Acrylic, 4% Polyamide, 1% Elastane Features:
 • Classic fit, all purpose beanie
 • Circular knit, plaited with elastane for good stretch and recovery
 • Jersey Knit

Colours:
 065 Raspberry
 598 Navy



065



598

67452 LOGO CUFF BEANIE

USD \$25

Sizes: STD Fitting: Regular CB/Inseam:
 Insulation: Water column: Weight:

Fabric: 100% Acrylic Features:
 • Knitted Beanie
 • Cuff construction
 • Regular fit

Colours:
 482 Beluga
 597 Navy
 662 Wild Rose



482



597



662



ACCESSORIES

67195 BUSINESS BEANIE 2

USD \$35

Sizes: STD **Fitting:** Regular **CB/Inseam:**
Insulation: **Water column:** **Weight:**

Fabric:
 40% Acrylic,
 39% Wool, 21%
 Polyamide

- Features:**
- 3 x 3 Rib Knit
 - Double layer
 - HH Logo
 - Wool blend
 - All purpose beanie

Colours:
 964 Charcoal
 Melange
 990 Black



964



990

67406 HH FLEECE BEANIE

USD \$20

Sizes: STD **Fitting:** Fitted **CB/Inseam:**
Insulation: **Water column:** **Weight:**

Fabric:
 100% Polyester

- Features:**
- 100g Recycled Polartec
 - Classic fleece beanie

Colours:
 213 Cayenne
 597 Navy
 990 Black



597



213



990

67451 CHAMPOW BEANIE

USD \$30

Sizes: STD **Fitting:** Regular **CB/Inseam:**
Insulation: **Water column:** **Weight:**

Fabric:
 Body: 100%
 Acrylic, Faux
 Fur Pom: 100%
 Polyester

- Features:**
- Circular knit
 - Knitted details
 - Pom pom

Colours:
 525 Turquoise
 597 Navy
 662 Wild Rose



597



525



662

67407 W SNOWFALL BEANIE

USD \$40

Sizes: STD **Fitting:** Fitted **CB/Inseam:**
Insulation: **Water column:** **Weight:**

Fabric:
 Body: 100%
 Acrylic, Faux
 Fur Pom: 100%
 Polyester

- Features:**
- Knitted beanie with Pom
 - Cozy inner fabric

Colours:
 011 Off White
 065 Raspberry
 597 Navy



011



065



597

67266 W CALGARY CHUNKY BEANIE

USD \$32

Sizes: STD Fitting: Fitted CB/Inseam:
 Insulation: Water column: Weight:

Fabric: 100% Acrylic
 Features:
 • 1x1 Rib turnback
 • Removable pom-pom
 • HH Logo

Colours:
 065 Raspberry
 421 Lav Green
 841 Penguin



065



421



841

67156 W LIMELIGHT BEANIE

USD \$35

Sizes: STD Fitting: Fitted CB/Inseam:
 Insulation: Water column: Weight:

Fabric: 70% Acrylic, 30% Wool, Faux Fur Pom: 100% Polyester
 Features:
 • 3 x 3 Rib Knit
 • Removable Faux Fur pom-pom

Colours:
 060 Misty Rose
 213 Cayenne
 990 Black



060



213



990

67152 W POWDER BEANIE

USD \$35

Sizes: STD Fitting: Fitted CB/Inseam:
 Insulation: Water column: Weight:

Fabric: Shell : 100% Acrylic, Lining : 95% Polyester, 5% Elastane
 Features:
 • Ladderback Jacquard
 • High Pile Fleece Lining
 • Removable Pom

Colours:
 001 White
 597 Navy



001



597

67306 HH MERINO NECK

USD \$30

Sizes: STD Fitting: Regular CB/Inseam:
 Insulation: Water column: Weight:

Fabric: 100% Merino Wool
 Features:
 • 100% Merino Wool
 • HH Logo

Colours:
 949 Grey Melange
 990 Black



949



990



ACCESSORIES

67963 HH NECK

USD \$12

Sizes: STD
Fitting: Regular
CB/Inseam:

Insulation:
Water column:
Weight:

Fabric:
100% Polyester

Features:

- Fundamental protective design for neck warmth
- Generous length
- Light fabric
- Customization of fit with reduced bulk

Colours:
223 Alert Red Hh
Logo
421 Lav Green
980 Ebony
992 Black



223

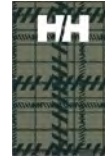

421



980



992

GLOVES

67417 ODIN GLOVES

USD \$140

Sizes: XS-L
Fitting: Regular
CB/Inseam:

Insulation:
Water column:
Weight:

Fabric:
Outer Glove - Shell:
58% Nylon, 42%
Leather - Lining:
100% Polyester -
Insulation: 100%
Polyester - Insert:
HIPORA

Features:

- Ultimate 2-in-1 glove system for backcountry touring
- Removable liner glove for the uphill climb
- Packable/ Durable outer shell w/ Helly Tech® waterproof/ breathable insert
- Outer shell lined with polypropylene liner material for comfort/ warmth when worn without the internal removable liner glove
- Goat skin palm for grip and tactility

Colours:
990 Black



990

67460 LEATHER MIX GLOVE

USD \$90

Sizes: S-XL
Fitting: Regular
CB/Inseam:

Insulation:
Water column:
Weight:

Fabric:
Shell: 67% Leather,
21% Polyester,
8% Nylon, 4%
Polyurethane,
Lining: 100%
Polyester,
Insulation: 100%
Polyester, Insert:
TPU

Features:

- Waterproof/Breathable Insert, Grade A goat skin leather, goggle/nose wipe, touch capable index and thumb.

Colours:
597 Navy
990 Black



597



990

67461 ALL MOUNTAIN GLOVE

USD \$50

Sizes: S-XL
Fitting: Regular
CB/Inseam:

Insulation:
Water column:
Weight:

Fabric:
Shell: 82%
Polyester, 18%
Polyurethane,
Lining: 100%
Polyester,
Insulation: 100%
Polyester, Insert:
100% TPU

Features:

- Waterproof/Breathable Insert, Grade A goat skin leather, sock cuff wrist, goggle/nose wipe, touch capable index and thumb, and backhand knuckle pad.

Colours:
983 Slate
990 Black



990

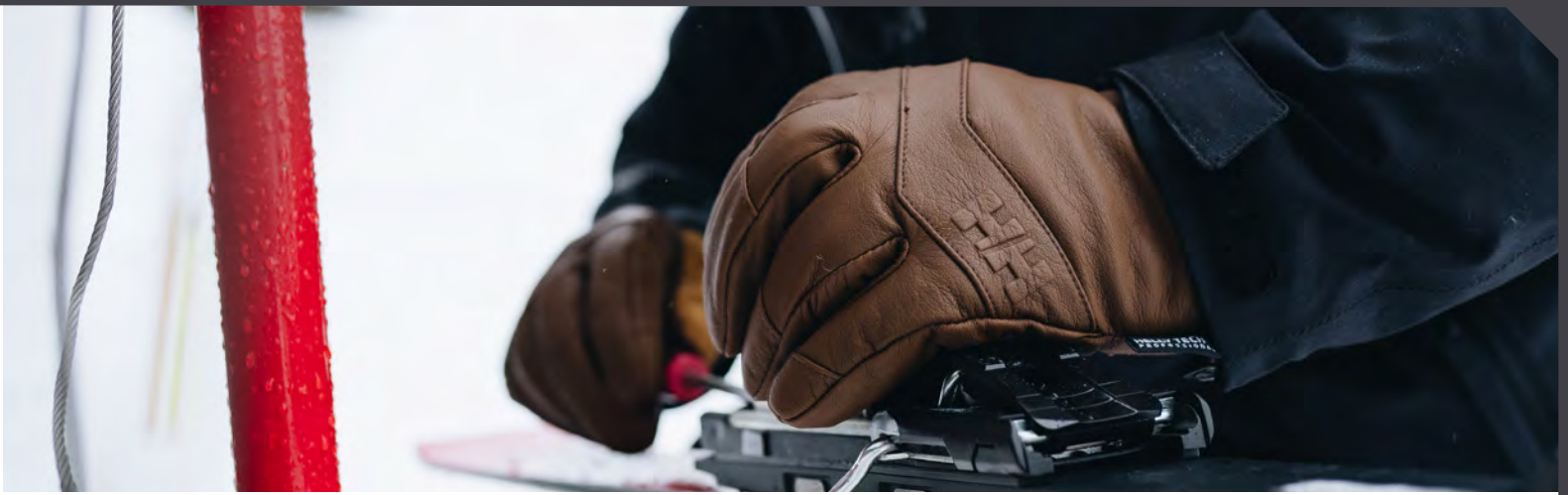

67454 GLACIER GLOVE

USD \$70

Sizes: S-XL
Fitting: Regular
CB/Inseam:
Insulation:
Water column:
Weight:

Fabric:
 Shell: 74% Polyester, 26% Polyurethane,
 Lining: 100% Polyester,
 Insulation: 100% Polyester, Insert: HIPORA
Features:
 • Waterproof/Breathable Insert, durable synthetic palm, goggle/nose wipe, highloft lining, touch capable

Colours:
 421 Lav Green
 597 Navy
 990 Black



421



597



990

67457 JUNIPER GLOVE

USD \$60

Sizes: S-XL
Fitting: Regular
CB/Inseam:
Insulation:
Water column:
Weight:

Fabric:
 Shell: 73% Polyester, 27% Polyurethane,
 Lining: 100% Polyester,
 Insulation: 100% Polyester, Insert: HIPORA
Features:
 • Waterproof/Breathable Insert, durable synthetic palm, goggle/nose wipe, highloft lining, touch capable

Colours:
 421 Lav Green
 597 Navy
 990 Black



421



597



990

67324 SWIFT HT GLOVE

USD \$70

Sizes: XS-L
Fitting: Regular
CB/Inseam:
Insulation:
Water column:
Weight:

Fabric:
 Shell : 28% Leather, 72% Polyester
 Lining : 100% Polyester
 Insulation : 100% Polyester
 Insert : Hipora
Features:
 • Shell: Micro smooth weave
 • Palm: PU Palm
 • Insert: HELLY TECH® Performance, waterproof and breathable insert
 • Insulation: 6oz Fiber Fill
 • Lining: Anti pilling polyester micro fleece
 • Closure: Hook/Loop

Colours:
 001 White
 597 Navy
 990 Black



597



001



990



ACCESSORIES

67335 SWIFT HT MITTENS

USD \$70

Sizes: XS-L **Fitting:** Regular **CB/Inseam:**

Insulation: **Water column:** **Weight:**

Fabric:
Shell : 32%
Leather, 68%
Polyester
Lining : 100%
Polyester
Insulation : 100%
Polyester
Insert : Hipora

- Features:**
- Shell: Micro smooth weave
 - Palm: Premium water repellent goat skin leather
 - Insert: HELLY TECH® Performance, waterproof and breathable insert
 - Insulation: 3M™ Thinsulate™ 150C insulation
 - Lining: Anti pilling polyester micro fleece
 - Closure: Hook/Loop

Colours:
597 Navy
990 Black



597



990

67806 VOR GLOVE

USD \$95

Sizes: XS-L **Fitting:** Regular **CB/Inseam:**

Insulation: **Water column:** **Weight:**

Fabric:
Shell : 99%
Leather, 1%
Polyester
Lining : 100%
Polyester
Insulation : 100%
Polyester

- Features:**
- Shell and Palm: Premium water repellent goat skin leather
 - Lining: anti pilling polyester micro fleece
 - Closure: Sock cuff with cinch strap
 - Classic "work glove" styling

Colours:
719 Cedar Brown



719

67145 DAWN PATROL GLOVE

USD \$90

Sizes: XS-L **Fitting:** Regular **CB/Inseam:**

Insulation: **Water column:** **Weight:**

Fabric:
SHELL : 79%
Leather, 17%
Polyester, 4%
Cotton
Insulation: 100%
Polyester
Lining: 100%
Polyester

- Features:**
- Leather palm reinforcement
 - Leather pull tab
 - Easy on / off sock cuff
 - Workwear styling ribbed sock cuff closure
 - Anti pilling polyester micro fleece lining
 - 3M™ Thinsulate™ insulation 40g Insulation
 - Goat skin leather Palm
 - Skin leather DX weave / Premium water repellent goat Shell

Colours:
990 Black



990

67418 ROAM GLOVES

USD \$45

Sizes: S-XL **Fitting:** Regular **CB/Inseam:**

Insulation: **Water column:** **Weight:**

Fabric:
85% Wool, 15%
Acrylic

- Features:**
- Wool Gloves
 - Reinforced palm
 - Convertible mitten flap cover

Colours:
597 Navy
857 Pelican



597



857

67332 HH FLEECE TOUCH GLOVE LINER

USD \$30

Sizes: S-XL
Fitting: Fitted
CB/Inseam:
Insulation:
Water column:
Weight:

Fabric:
 Shell : 82% Polyester, 4% Spandex, 8% Nylon, 6% Polyurethane
Features:
 • Touch capable index finger & thumb
 • Reinforced palm

Colours:
 971 Quiet Shade
 990 Black



971



990

68084 HH LIFA MERINO GLOVE LINER

USD \$30

Sizes: S-XL
Fitting: Fitted
CB/Inseam:
Insulation:
Water column:
Weight:

Fabric:
 57% Merino Wool, 43% Polypropylene
Features:
 • HH LIFA® Merino
 • Merino wool
 • Dry next to skin
 • Extra warmth
 • Non itch

Colours:
 990 Black



990

67463 W LEATHER MIX GLOVE

USD \$90

Sizes: XS-L
Fitting: Regular
CB/Inseam:
Insulation:
Water column:
Weight:

Fabric:
 Shell: 67% Leather, 21% Polyester, 8% Nylon, 4% Polyurethane, Lining: 100% Polyester, Insulation: 100% Polyester, Insert: TPU
Features:
 • Waterproof/Breathable Insert, Grade A goat skin leather, goggle/nose wipe, touch capable index and thumb.

Colours:
 662 Wild Rose
 990 Black



662



990

67464 W ALL MOUNTAIN GLOVE

USD \$50

Sizes: XS-L
Fitting: Regular
CB/Inseam:
Insulation:
Water column:
Weight:

Fabric:
 Shell: 82% Polyester, 18% Polyurethane, Lining: 100% Polyester, Insulation: 100% Polyester, Insert: 100% TPU
Features:
 • Waterproof/Breathable Insert, Grade A goat skin leather, sock cuff wrist, goggle/nose wipe, touch capable index and thumb, and backhand knuckle pad.

Colours:
 597 Navy
 990 Black



990



ACCESSORIES

67465 W FREERIDE MIX GLOVE

USD \$70

Sizes: XS-L
Fitting: Regular
CB/Inseam:

Insulation:
Water column:
Weight:

Fabric:
 Shell: 70% Polyester, 30% Leather, Lining: 100% Polyester,
 Insulation: 100% Polyester, Insert: 100% TPU

Features:
 • Goat Skin leather palm, premium waterproof/breathable insert, Gauntlet Storm cuff, Touch Capable

Colours:
 525 Turquoise
 990 Black



990

67455 W GLACIER GLOVE

USD \$70

Sizes: XS-L
Fitting: Regular
CB/Inseam:

Insulation:
Water column:
Weight:

Fabric:
 Shell: 74% Polyester, 26% Polyurethane, Lining: 100% Polyester,
 Insulation: 100% Polyester, Insert: HIPORA

Features:
 • Waterproof/Breathable Insert, durable synthetic palm, goggle/nose wipe, highloft lining, touch capable

Colours:
 525 Turquoise
 597 Navy
 662 Wild Rose



525



597



662

67458 W JUNIPER GLOVE

USD \$60

Sizes: XS-L
Fitting: Regular
CB/Inseam:

Insulation:
Water column:
Weight:

Fabric:
 Shell: 73% Polyester, 27% Polyurethane, Lining: 100% Polyester,
 Insulation: 100% Polyester, Insert: HIPORA

Features:
 • Waterproof/Breathable Insert, durable synthetic palm, goggle/nose wipe, highloft lining, touch capable

Colours:
 525 Turquoise
 597 Navy
 662 Wild Rose



662



597



525

67352 JR SWIFT HT GLOVE

USD \$50

Sizes: 8,10,12,14,
Fitting: Regular
CB/Inseam:

Insulation:
Water column:
Weight:

Fabric:
 Shell : 74% Polyester, 26% Polyurethane, Lining : 100% Polyester,
 Insulation : 100% Polyester, Insert : Hipora

Features:
 • Shell: Micro smooth weave
 • Palm: PU Palm
 • Insert: HELLY TECH® Performance, waterproof and breathable insert
 • Insulation: 6oz Fiber Fill
 • Lining: Anti pilling polyester micro fleece
 • Closure: Hook/Loop

Colours:
 538 Sonic Blue
 657 Purple Potion
 990 Black



657



538



990

67346 JR SWIFT HT MITTEN

USD \$50

Sizes: 8,10,12,14, **Fitting:** Regular **CB/Inseam:**

Insulation: **Water column:** **Weight:**

- Fabric:**
 Shell : 32%
 Leather, 68%
 Polyester, Lining
 : 100% Polyester,
 Insulation : 100%
 Polyester, Insert :
 Hipora
- Features:**
 • Shell: Micro smooth weave
 • Palm: PU Palm
 • Insert: HELLY TECH® Performance,
 waterproof and breathable insert
 • Insulation: 6oz Fiber Fill
 • Lining: Anti pilling polyester micro fleece
 • Closure: Hook/Loop

Colours:
 597 Navy
 657 Purple Potion
 990 Black



67468 ALPINE SOCK WARM

USD \$35

SOCKS

Sizes: 36-38,39-41,42-44,45-47, **Fitting:** Fitted **CB/Inseam:**

Insulation: **Water column:** **Weight:**

- Fabric:**
 46% Merino Wool,
 27% Polyamide,
 24% Polycolon, 3%
 Elastane
- Features:**
 • Shin & Calf protector
 • Tight knitted panel around foot
 • L & R construction
 • Terry heel & toe

Colours:
 255 Liberty
 793 Redwood
 990 Black



67470 ALPINE SOCK TECHNICAL

USD \$30

Sizes: 36-38,39-41,42-44,45-47, **Fitting:** Fitted **CB/Inseam:**

Insulation: **Water column:** **Weight:**

- Fabric:**
 36% Merino Wool,
 36% Acrylic, 24%
 Polyamide, 4%
 Elastane
- Features:**
 • Shin protector
 • Ribbed panel around end of ankle
 • Mesh LIFA® stripes
 • Ribbed panel around foot
 • Flat toe seam
 • Terry toe

Colours:
 300 Patrol Orange
 983 Slate
 990 Black



67469 ALPINE SOCK MEDIUM

USD \$25

Sizes: 36-38,39-41,42-44,45-47, **Fitting:** Fitted **CB/Inseam:**

Insulation: **Water column:** **Weight:**

- Fabric:**
 33% Polycolon,
 32% Polyamide,
 31% Merino Wool,
 4% Elastane
- Features:**
 • Mesh panel at top foot
 • L & R construction
 • Flat toe seam
 • Terry toe and sole

Colours:
 488 Scarab Green
 662 Wild Rose
 990 Black



ACCESSORIES

67403 HH WOOL CAP

USD \$40

Sizes: STD Fitting: Regular CB/Inseam:
 Insulation: Water column: Weight:

Fabric:
 50% Wool, 50% Polyester

- Features:
- 6 panel cap
 - Snapback construction
 - Quilted comfort sweatband
 - One size fits most

Colours:
 215 Oxblood
 964 Charcoal
 990 Black



215



964

990

67300 HH BRAND CAP

USD \$35

Sizes: STD Fitting: Regular CB/Inseam:
 Insulation: Water column: Weight:

Fabric:
 100% Polyester

- Features:
- 100% Polyester
 - One size fits most

Colours:
 001 White
 482 Beluga Nmm Print
 597 Navy
 990 Black



001



482

597

990

67155 HH FLATBRIM TRUCKER CAP

USD \$30

Sizes: STD Fitting: Regular CB/Inseam:
 Insulation: Water column: Weight:

Fabric:
 50% Cotton, 50% Polyester

- Features:
- 5 panel cap with buckram front lining
 - Classic mesh back
 - Quilted comfort sweatband
 - One size fits most

Colours:
 482 Beluga
 599 Navy
 983 Slate



599



482

983

BELTS

67413 HH ADVENTURE BELT

USD \$30

Sizes: 130,140, Fitting: Regular CB/Inseam:
 Insulation: Water column: Weight:

Fabric:
 65% Polyester, 35% Spandex

- Features:
- Stretch belt
 - Easily adjustable
 - Embossed HH® logo

Colours:
 597 Navy
 857 Pelican
 990 Black



597



857

990

67363 HH WEBBING BELT

USD \$25

Sizes: 130,140, Fitting: Regular CB/Inseam:
 Insulation: Water column: Weight:

Fabric: 100% Polyamide
 Features:
 • Aluminum buckle
 • Easily adjustable
 • Durable polyester webbing
 • Embossed HH® logo

Colours:
 300 Patrol Orange
 597 Navy
 990 Black



597

300

990

67003 HH SEAMLESS CAP

USD \$35

Sizes: STD Fitting: Regular CB/Inseam:
 Insulation: Water column: Weight:

Fabric: 100% Polyester
 Features:
 • Seamless construction
 • Quick dry fabric
 • Injection molded logo

Colours:
 001 White
 597 Navy
 990 Black



001

597

990

67160 CREW CAP

USD \$20

Sizes: STD Fitting: Fitted CB/Inseam:
 Insulation: Water column: Weight:

Fabric: 100% Polyester
 Features:
 • 100% cotton
 • Washed finish
 • Back adjustment
 • HH® logo on front
 • One size fits all
 • Unisex
 • 6 pack

Colours:
 001 White
 597 Navy
 990 Black



597

001

990

38791 LOGO CAP

USD \$20

Sizes: STD Fitting: Fitted CB/Inseam:
 Insulation: Water column: Weight:

Fabric: Face: 100% Polyamide / Back: 100% Polyurethane
 Features:
 • 100% cotton
 • Washed finish
 • Back adjustment
 • HH® logo on front
 • One size fits all
 • Unisex
 • 6 pack

Colours:
 001 White
 597 Navy
 990 Black



990

001

597



ACCESSORIES

67771 SAILING GLOVE LONG

USD \$35

Sizes: S-XL
Fitting: Regular
CB/Inseam:

Insulation:
Water column:
Weight:

Fabric:
 100% Polyester

Features:
 • Durable long finger leather gloves for sailing in conditions where extra protection is needed

Colours:
 990 Black



990

67772 SAILING GLOVE SHORT

USD \$33

Sizes: S-XL
Fitting: Regular
CB/Inseam:

Insulation:
Water column:
Weight:

Fabric:
 100% Polyester

Features:
 • Durable short finger leather gloves for sailing in conditions where extra protection is needed

Colours:
 990 Black



990

67421 SPORT DUFFEL 50L

USD \$70

Sizes:
 50L

Dimensions:
 60cm x 29cm x 29cm

Fabric:
 100% Polyester

Colours:
 300 Patrol Orange
 597 Navy
 964 Charcoal
 990 Black

Features:
 • 600D Hi Count Polyester with DWR and PU2 backing
 • YKK® zippers
 • Main zipper is lockable
 • Double layer bottom for durability
 • One external and one internal pocket, the internal pocket doubles as the storage pocket for the duffel (when packed)
 • Adjustable and padded shoulder strap



YKK



300



597

964

990

67431 SPORT DUFFEL 70L

USD \$85

BAGS

Sizes:
 70L

Dimensions:
 66cm x 33cm x 33cm

Fabric:
 100% Polyester

Colours:
 300 Patrol Orange
 597 Navy
 964 Charcoal
 990 Black

Features:
 • 600D Hi Count Polyester with DWR and PU2 backing
 • YKK® zippers
 • Main zipper is lockable
 • Double layer bottom for durability
 • One external and one internal pocket, the internal pocket doubles as the storage pocket for the duffel (when packed)
 • Adjustable and padded shoulder strap



YKK



300



597

964

990

67432 SPORT DUFFEL 90L

USD \$100

Sizes:
90L

Dimensions:
69cm x 36.5cm x 36.5cm

Fabric:
100% Polyester

Colours:
300 Patrol Orange
597 Navy
964 Charcoal
990 Black

- Features:**
- 600D Hi Count Polyester with DWR and PU2 backing
 - YKK® zippers
 - Main zipper is lockable
 - Double layer bottom for durability
 - One external and one internal pocket, the internal pocket doubles as the storage pocket for the duffel (when packed)
 - Adjustable and padded shoulder strap

YKK®



300



597

964

990

67440 H/H SCOUT DUFFEL S

USD \$90

Sizes:
30L

Dimensions:
53cm x 24cm x 24cm

Fabric:
100% Polyester

Colours:
070 Ibis Rose
421 Lav Green
598 Navy
622 Tundra Blue
639 Electric Blue
648 Glacier Blue
980 Ebony
990 Black

- Features:**
- 600D Polyester with TPU
 - PVC-Free
 - Large U-shaped opening into main compartment
 - Separate shoe pocket for storage of shoes or clothes
 - Hidden padded shoulder straps in top lid pocket
 - YKK® zippers
 - Main zipper is lockable

YKK®



070



648

980

990



421

598

622

639

67441 H/H SCOUT DUFFEL M

USD \$100

Sizes:
50L

Dimensions:
64cm x 28cm x 28cm

Fabric:
100% Polyester

Colours:
070 Ibis Rose
421 Lav Green
598 Navy
622 Tundra Blue
639 Electric Blue
648 Glacier Blue
980 Ebony
990 Black

- Features:**
- 600D Polyester with TPU
 - PVC-Free
 - Large U-shaped opening into main compartment
 - Separate shoe pocket for storage of shoes or clothes
 - Hidden padded shoulder straps in top lid pocket
 - YKK® zippers
 - Main zipper is lockable

YKK®



070



648

980

990



421

598

622

639

67442 H/H SCOUT DUFFEL L

USD \$110

Sizes:
70L

Dimensions:
68cm x 32cm x 32cm

Fabric:
100% Polyester

Colours:
070 Ibis Rose
421 Lav Green
598 Navy
622 Tundra Blue
639 Electric Blue
648 Glacier Blue
980 Ebony
990 Black

- Features:**
- 600D Polyester with TPU
 - PVC-Free
 - Large U-shaped opening into main compartment
 - Separate shoe pocket for storage of shoes or clothes
 - Hidden padded shoulder straps in top lid pocket
 - YKK® zippers
 - Main zipper is lockable

YKK®



070



648

980

990



421

598

622

639



ACCESSORIES

67443 H/H SCOUT DUFFEL XL

USD \$120

Sizes:
90L

Dimensions:
73cm x 35cm x 35cm

Fabric:
100% Polyester

Colours:
070 Ibis Rose
322 Papaya
421 Lav Green
598 Navy
622 Tundra Blue
639 Electric Blue
648 Glacier Blue
980 Ebony
990 Black

- Features:**
- 600D Polyester with TPU
 - PVC-Free
 - Large U-shaped opening into main compartment
 - Separate shoe pocket for storage of shoes or clothes
 - Hidden padded shoulder straps in top lid pocket
 - YKK® zippers
 - Main zipper is lockable

YKK



070



639

648

980

990



322

421

598

622

67444 H/H SCOUT WASH BAG

USD \$30

Sizes:
5L

Dimensions:
27cm x 15cm x 14cm

Fabric:
100% Polyester

Colours:
070 Ibis Rose
421 Lav Green
598 Navy
622 Tundra Blue
639 Electric Blue
648 Glacier Blue
980 Ebony
990 Black

- Features:**
- 600D Polyester with TPU
 - PVC-Free
 - Large U-shaped opening into main compartment
 - Internal mesh pocket
 - Webbing hanger loop
 - YKK® zipper

YKK

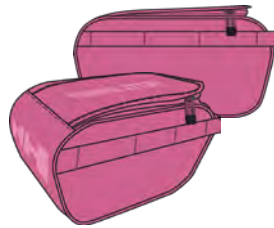

070

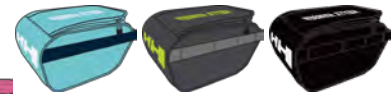

648

980

990

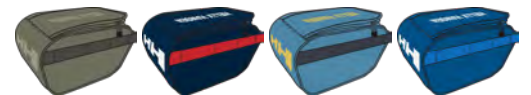

421

598

622

639

67386 DUBLIN 2.0 BACKPACK

USD \$55

Sizes:
33L

Dimensions:
43.5cm x 31cm x 11.5cm

Fabric:
Face: 100% Polyester / Back: 100% Polyurethane

Colours:
964 Charcoal
990 Black

- Features:**
- 2 main compartments accessible with zip
 - External pocket with zip
 - Dual external compartments
 - Carry handle on top
 - Adjustable, padded shoulder straps
 - Computer sleeve inside



964



990

67184 OSLO BACKPACK

USD \$55

Sizes:
20L

Dimensions:
46cm x 29cm x 13cm

Fabric:
100% Polyester

Colours:
070 Ibis Rose
482 Beluga
598 Navy

- Features:**
- Approximately 20L
 - One large main compartment with zip
 - External front compartment with zip
 - Dual external compartments
 - Carry handle on top
 - Adjustable, padded shoulder straps
 - Computer sleeve inside
 - Heritage HH® logo

YKK



070



598



482

67000 KITSILANO BACKPACK

USD \$75

Sizes:
25L

Dimensions:
45cm x 30cm x 19cm

Fabric:
100% Polyester

Colours:
301 Patrol Orange
Multicolor
421 Lav Green
984 Slate
Multicolor
990 Black

Features:

- 600D Polyester with DWR and PU backing
- Front pocket with key clip and organization slots
- Main compartment with unpadding sleeve
- Printed lining
- Synthetic leather trim
- Well padded shoulder straps with air mesh backing for comfort and ventilation



984



301



421



990

67436 VISBY BACKPACK

USD \$110

Sizes:
30L

Dimensions:
48.5cm x 29cm x 22cm

Fabric:
100% Nylon

Colours:
469 Forest Night
983 Slate

Features:

- 630D Nylon Cordura® HT with DWR and PU backing
- Hypalon accent panel
- Top lid pocket with key clip
- Main compartment with spindrift collar closure
- Padded computer sleeve
- Shaped PE board back panel
- Multi level foam back panel with mesh overlay for comfort and ventilation
- Removeable/adjustable sternum strap system



469



983

67187 STOCKHOLM BACKPACK

USD \$75

Sizes:
28L

Dimensions:
45cm x 30cm x 15cm

Fabric:
Face: 100% Polyester / Back: 100% Polyvinyl Chloride

Colours:
300 Patrol Orange
622 Tundra Blue
971 Quiet Shade
980 Ebony
990 Black

Features:

- Approximately 28L
- Waterproof main fabric
- Roll top construction with buckles
- Large main compartment
- Front compartment with zip
- Adjustable, padded shoulder straps



300



622



971



980



990

67188 LOKE BACKPACK

USD \$70

Sizes:
25L

Dimensions:
50cm x 17cm x 30.5cm

Fabric:
100% Polyamide

Colours:
793 Redwood
971 Quiet Shade
983 Slate
990 Black

Features:

- Approximately 25L
- Durable Poly Oxford fabric
- One large main compartment with zip
- Padded laptop sleeve
- Internal organizer
- External pocket with key-hook
- Reflective printing
- External daisy-chain
- Adjustable sternum strap
- Side compression straps
- Elastic side pockets



793



971



983



990



ACCESSORIES

67370 HH OCEAN DRY BAG L

USD \$50

Sizes:

24L

Dimensions:

50.5cm x 54.5cm, Diameter 28cm

Fabric:

100% Nylon

Colours:

222 Alert Red

Features:

- Made from 420D Nylon with TPU backing
- Roll-top with buckle closure
- D-ring attachment point
- Removable shoulder strap
- Radio Frequency welded seams ensure complete waterproofness
- Note: these bags do not provide waterproof protection if completely submerged



222

67371 HH OCEAN DRY BAG XL

USD \$70

Sizes:

43L

Dimensions:

50.5cm x 89.5cm, Diameter 28cm

Fabric:

100% Nylon

Colours:

222 Alert Red

Features:

- Made from 420D Nylon with TPU backing
- Roll-top with buckle closure
- D-ring attachment point
- Removable shoulder strap
- Radio Frequency welded seams ensure complete waterproofness
- Note: these bags do not provide waterproof protection if completely submerged



222

67372 HH LIGHT DRY BAG 3L

USD \$15

Sizes:

3L

Dimensions:

20cm x 17cm x 9cm

Fabric:

100% Nylon

Colours:

990 Black

Features:

- Made from light weight 70D Nylon with TPU backing
- Roll-top with buckle closure
- D-ring attachment point
- Fully taped seams to keep out water
- Note: these bags do not provide waterproof protection if completely submerged



990

67373 HH LIGHT DRY BAG 7L

USD \$20

Sizes:

7L

Dimensions:

26cm x 20cm x 15cm

Fabric:

100% Nylon

Colours:

990 Black

Features:

- Made from light weight 70D Nylon with TPU backing
- Roll-top with buckle closure
- D-ring attachment point
- Fully taped seams to keep out water
- Note: these bags do not provide waterproof protection if completely submerged



990

67374 HH LIGHT DRY BAG 12L

USD \$25

Sizes:
12L
Dimensions:
33cm x 23cm x 16cm

- Fabric:**
100% Nylon
- Colours:**
990 Black
- Features:**
- Made from light weight 70D Nylon with TPU backing
 - Roll-top with buckle closure
 - D-ring attachment point
 - Fully taped seams to keep out water
 - Note: these bags do not provide waterproof protection if completely submerged



990

67375 HH LIGHT DRY BAG 20L

USD \$30

Sizes:
20L
Dimensions:
44cm x 27cm x 20cm

- Fabric:**
100% Nylon
- Colours:**
990 Black
- Features:**
- Made from light weight 70D Nylon with TPU backing
 - Roll-top with buckle closure
 - D-ring attachment point
 - Fully taped seams to keep out water
 - Note: these bags do not provide waterproof protection if completely submerged



990

67381 HH RACING BAG

USD \$80

Sizes:
44L
Dimensions:
55cm x 31cm x 26cm

- Fabric:**
100% Polyester
- Colours:**
148 Cherry Tomato
990 Black
- Features:**
- Adjustable backpack straps
 - Ventilated wet compartment
 - Separate dry compartment
 - Grab handles on both sides for easy handling
 - PFC free
 - Zipped outside mesh pocket



148



990

67433 MARINE TOTE

USD \$60

Sizes:
24L
Dimensions:
43.5cm x 37.5cm x 16cm

- Fabric:**
100% Polyester
- Colours:**
071 Melon
597 Navy
- Features:**
- Carry as a tote or a shoulder bag (with the deployable shoulder straps)
 - Internal zippered pocket
 - Full lining



071



597



67439 MARINE BAG

USD \$80

Sizes:
33L

Dimensions:
52cm x 34cm x 18.5cm

Fabric:
100% Polyester

Colours:
071 Melon
421 Lav Green
597 Navy

- Features:**
- Great weekend bag
 - Large main compartment
 - Inside slip pocket
 - Internal zippered pocket
 - Full lining



071



421

597





FOOT-WEAR

MEN'S





WINTERBOOTS

11422 GARIBALDI V3

USD \$160

Colours:

720 Fallen Rock / Bungee Cord / Aluminum, 724 New Wheat / Black / Soccer Gum, 766 Tobacco Brown / Espresso / Natura, 991 Jet Black / Charcoal / Black Gum

Sizes:

7,7.5,8,8.5,9,9.5,10,10.5,11,11.5,12,13

Description:

Keep warm while looking your best. The Garibaldi snow boot is the perfect blend of style and function with its protective toe-to-heel rand combined with waterproof nubuck leathers and a warm faux fur lining.

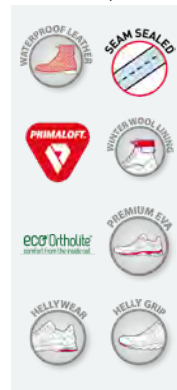

11649 GARIBALDI PRIMALOFT BOOT

USD \$185

Colours:

991 Jet Black / Ash Grey

Sizes:

7,7.5,8,8.5,9,9.5,10,10.5,11,11.5,12,13

Description:

The Gribaldi Primloft is our tall, casual winterboot which offers all the warmth and comfort needed during those cold winter months. This boot features waterproof leather, fully seam sealed, 200g of Primaloft insulation and a faux shearing lining.

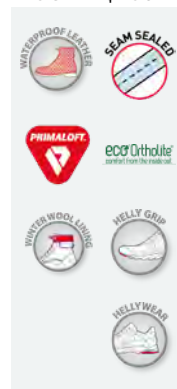

11632 GAMVIK

USD \$140

Colours:

744 Cement / Black, 990 Black

Sizes:

7,7.5,8,8.5,9,9.5,10,10.5,11,11.5,12,13

Description:

The Gamvik winterboot features a fully waterproof rubber shell, a hydrophobic and seam sealed upper part with an internal removable, insulated Felt sock, Faux Fur top-line and an aluminum shield blocker.

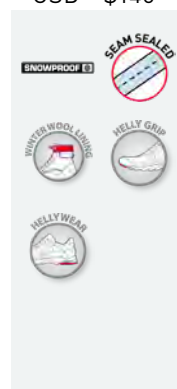

11536 TUNDRA CWB 2

Colours:
991 Jet B / New Light Grey / Charc

Sizes:
7,7.5,8,8.5,9,9.5,10,10.5,11,11.5,12,13

Description:
The ultimate in cold-weather snowboots; The Tundra CWB offers warmth and comfort in abundance. This tall, protective Snowboot features Snowproof, seam-sealed construction, with non-wicking textiles, and 600grams worth of warm Primaloft insulation. The outsole has a tire-thread pattern coupled with our proven cold-weather rubber compounds for the best-in-class grip.

USD \$175

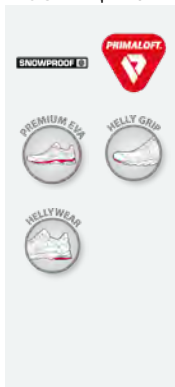

11630 VARANGER PRIMALOFT

Colours:
746 Brunette / Black, 990 Black

Sizes:
7,7.5,8,8.5,9,9.5,10,10.5,11,11.5,12,13

Description:
The Varanger is our ultimate casual cold-weather boot featuring a protective rubber shell, all waterproof leather upper, fully seam sealed, internal removable Primaloft and Felt insulated sock, Faux Fur sockliner with aluminum shield blocker.

USD \$160

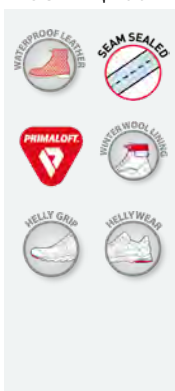

11625 SHERWOOD INSULATED

Colours:
745 Bushwacker / Sperry Gum, 990 Black / Black Gum

Sizes:
7,7.5,8,8.5,9,9.5,10,10.5,11,11.5,12,13

Description:
Sitting on a rugged work boot sole The Sherwood Insulated features an EVA rand providing extra insulation and comfort. This is a clean, classic and sleek boot, crafted in waterproof leathers with a medial zipper, a warm faux-fur lining, and also featuring Primaloft insulation in order to keep your feet warm, dry and comfortable.

USD \$165



11650 ODIN PRIMALOFT HIKER HT

Colours:
990 Black / Charcoal / Gunmetal

Sizes:
7,7.5,8,8.5,9,9.5,10,10.5,11,11.5,12,13

Description:
Looking for the best comfort, warmth and protection whether in the city or up in the mountain?; The Odin Primaloft Hiker will provide you with a warm, insulated and waterproof upper, and a high performance dual-density EVA midsole. Our HellyGrip outsole rubber compound offer great traction in all terrain and conditions.

USD \$220





CASUAL BOOTS & SHOES

11516 LOKE BOWRON LEATHER

Colours:

713 Espresso / Bungee Cord / Aluminum, 964 Charcoal / Ebony / Redwood, 990 Black / Ebony / New Light Grey

Sizes:

7,7.5,8,8.5,9,9.5,10,10.5,11,11.5,12,13

Description:

Great look, comfort, quality and protection; The Loke Bowron in full-grain waterproof leather and suede is a great outdoor classic. This versatile silhouette is a great companion on all types of trails; from the city to the forest.

USD \$120



11647 VERNON LEATHER

Colours:

689 Evening Blue / Off White, 720 Fallen Rock / Aluminum / Cream, 741 Whiskey / Castle Wall, 990 Black / Black

Sizes:

7,7.5,8,8.5,9,9.5,10,10.5,11,11.5,12,13

Description:

A contemporary rubber cupssole low-cut sneaker with full-grain leather and rugged suede giving it a uniquely refined look. Perfect with jeans and boasting the classic Helly Hansen H/H logo.

USD \$110

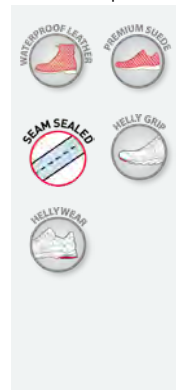

11157 GERTON

Colours:

725 New Wheat / Cashew / Off White, 745 Bushwacker / Cream, 990 Jet Black / Off White / Charcoal

Sizes:

7,7.5,8,8.5,9,9.5,10,10.5,11,11.5,12,13

Description:

Rugged, yet refined; The felt-lined Gerton leather mid-cut is your perfect everyday partner with jeans once fall settles and the cold weather sets in.

USD \$130



11510 STOCKHOLM 2

Colours:

597 Navy / Off White, 713 Coffee Bean / Cream, 725 Honey Wheat / Cashew / Off White, 991 Jet Black / Ebony

Sizes:

7,7.5,8,8.5,9,9.5,10,10.5,11,11.5,12,13

Description:

Come rain or shine, these stylish sneaker-boots are the epitome of Scandinavian design. No winter is complete without a fair share of sleet and snow, and these warm, protective, comfortable and light-weight boots can tackle all conditions with ease. And the best part is that you look good whilst doing it.

USD \$130

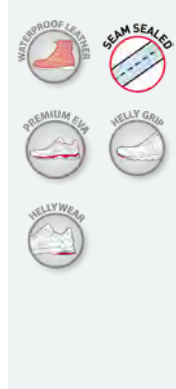

11624 MONTESANO BOOT

Colours:

597 Navy / Camel / Cream, 744 Peanuts / Shitake / Sperry Gum, 990 Black / Ebony

Sizes:

7,7.5,8,8.5,9,9.5,10,10.5,11,11.5,12,13

Description:

Montesano is this season's most stylish boot; Casually refined in beautiful leathers, yet packed with outdoor detailing and finishes from seasons past.

USD \$170

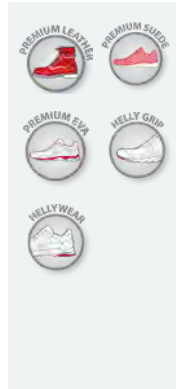

11620 SHADOWLAND

Colours:

771 Heritage Khaki / Kelp, 990 Black

Sizes:

7,7.5,8,8.5,9,9.5,10,10.5,11,11.5,12,13

Description:

The Shadowland has the attitude of a tactical boot with it's seamless and engineered upper packed with protective and tough materials.

USD \$150

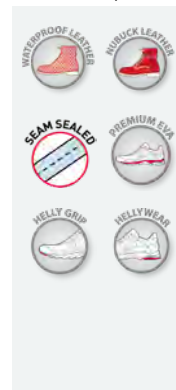

11611 RICHMOND

Colours:

597 Navy / Black / Sperry Gum, 726 Honey Wheat / Coffee Bean / Sperry Gum, 741 Cedar Brown / Espresso / Dark Gum, 990 Triple Black

Sizes:

7,7.5,8,8.5,9,9.5,10,10.5,11,11.5,12,13

Description:

This demi-cut casual boot offers great cushioning, comfort and traction. The upper consist of waterproof nubuck leathers and hydrophobic treated textiles

USD \$125

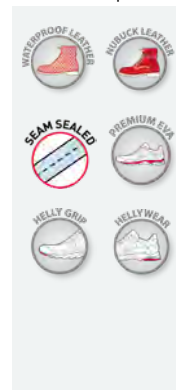

11618 TAMARACK

Colours:

597 Navy / North Sea Blue / Azid Lime, 720 Fallen Rock / Aluminum / Laurel Wreath, 990 Black

Sizes:

7,7.5,8,8.5,9,9.5,10,10.5,11,11.5,12,13

Description:

This stylish sneaker-hybrid combines winter protection with it's soft protective weathertight nubuck and supportive heel, whilst it's well cushioned and flexible Premium EVA midsole provides all the comfort needed.

USD \$120

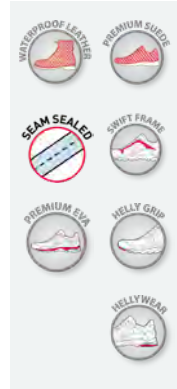

11622 KAMBO 1877 BOOT

Colours:

482 Beluga / Aluminum, 597 Navy / Slate / Sperry Gum, 647 Heritage Teal / Slate / Navy

Sizes:

7,7.5,8,8.5,9,9.5,10,10.5,11,11.5,12,13

Description:

The 1877 range celebrates our Scandinavian heritage, the oceans and the mountains, and through colors, graphics and design details The Alby Low sneaker pays tribute to the many H/H Ocean Race teams, through it's bold colors and graphics.

USD \$120

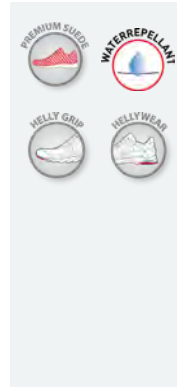

RAIN BOOTS

11660 NORDVIK 2

Colours:

597 Navy, 980 Ebony

Sizes:

7,8,9,10,11,12,13

Description:

Helly Hansen has produced weather protective gear since 1877, and rubber boots have always been at the core of our business. The Nordvik is a great option for casual use or as a companion down at the marina. These lower cut, lighter-weight boots effortlessly combine style, and comfort, whilst also featuring a flat, and siped outsole for great traction.

USD \$80

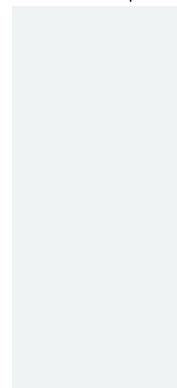

11662 MIDSUND 3

USD \$65

Colours:
597 Navy, 990 Black

Sizes:
7,8,9,10,11,12,13

Description:
Helly Hansen has produced weather protective gear since 1877, and rubber boots have always been at the core of our business. These Midsund wellies for men effortlessly combine style, comfort and weather protection.

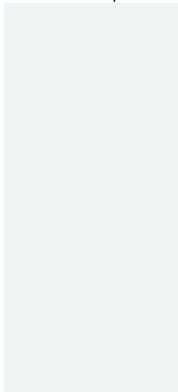

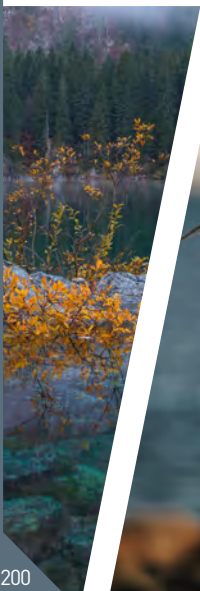

FOOT-WEAR

WOMEN'S





WINTERBOOTS

11633 W GAMVIK

USD \$140

Colours:

730 Cornstalk / Black, 990 Black

Sizes:

5F,6F,7F,8F,9F,10F,11F

Description:

The Gamvik winterboot features a fully waterproof rubber shell, a hydrophobic and seam sealed upper part with an internal removable, insulated Felt sock, Faux Fur top-line and an aluminum shield blocker.

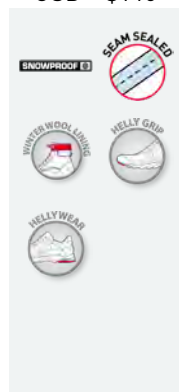

11592 W GARIBALDI VL

USD \$180

Colours:

421 Lav Green / Beluga / Pelican, 704 Camel / Coffe Bean / Bunge Cord / Natura Khaki / Angora / Sperry Gum, 745 Bushwacker / Coffee Bean / Sperry Gum, 991 Jet Black / Jet Black / Charcoal

Sizes:

5F,5.5F,6F,6.5F,7F,7.5F,8F,8.5F,9F,9.5F,10F,11F

Description:

The Women's Garibaldi snow boot is the perfect blend of style and function with it's protective toe-to-heel rand combined with waterproof nubuck leathers and a warm faux fur lining. Fully sealed seams, light-weight, protective, and stylish winterboot with unrivalled traction outsole and an Eco Ortholite comfort footbed.

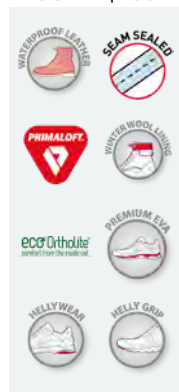

11652 W SORRENTO

USD \$140

Colours:

709 Bungee Cord / Espresso / Espresso Gum, 990 Black / Ebony / Black Gum

Sizes:

5F,5.5F,6F,6.5F,7F,7.5F,8F,8.5F,9F,9.5F,10F,11F

Description:

The Sorrento is comfortable warm and protective winter boot with toe to heel rand combined with WP Suede and Synthetic leather. It has an elegant durable textile collar and a warm faux fur lining, 100g of Primaloft, which makes it a perfect partner for those cold urban commutes.

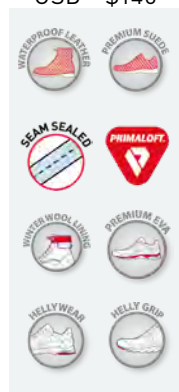

11537 W TUNDRA CWB 2

USD \$175

Colours:

011 Off White / Light Grey / F, 991 Jb / New L Grey / Char / Ang / Bl

Sizes:

5F,6F,7F,8F,9F,10F,11F

Description:

The ultimate in cold-weather snowboots; The Women's Tundra CWB offers warmth and comfort in abundance. This tall, protective Snowboot feature Snowproof, seam-sealed construction, with non-wicking textiles, and 600grams worth of warm Primaloft insulation. The outsole has a tire-thread pattern coupled with our proven cold-weather rubber compounds for the best-in-class grip.

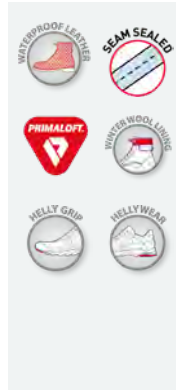

11631 W VARANGER PRIMALOFT

USD \$160

Colours:

741 Bistre / Black, 990 Black

Sizes:

5F,6F,7F,8F,9F,10F,11F

Description:

The Varanger is our ultimate casual cold-weather boot featuring a protective rubber shell, all waterproof leather upper, fully seam sealed, internal removable Primaloft and Felt insulated sock, Faux Fur sockliner with aluminum shield blocker.

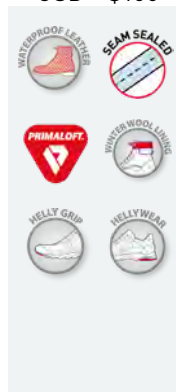

11636 W ANNABELLE BOOT

USD \$150

Colours:

720 Fallen Rock / Aluminum / Light Gum, 726 New Wheat / Natura / Light Gum, 766 Whiskey / Natura / Sperry Gum, 990 Black / Black Gum

Sizes:

5F,5.5F,6F,6.5F,7F,7.5F,8F,8.5F,9F,9.5F,10F,11F

Description:

The Women's Annabelle offers a truly unique blend of form and function. This stylish winter boot is comfortable, warm and keeps you protected from the environment. The waterproof leather and side zipper makes this faux-fur lined winterboot one of our most stylish and convenient slip-ons.

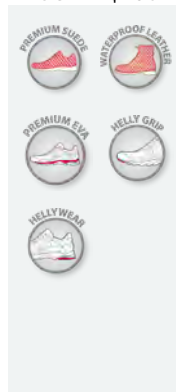

11527 W SERAPHINA DEMI

USD \$140

Colours:

725 New Wheat / Natura, 741 Whiskey / Frosted Almond / Red Gum, 990 Triple Black

Sizes:

5F,5.5F,6F,6.5F,7F,7.5F,8F,8.5F,9F,9.5F,10F,11F

Description:

This stylish, low-cut slip-on boot offers a truly unique blend of form and function, keeping you warm, comfortable, and protected from the environment.



WOMEN'S FOOTWEAR

11626 W SHERWOOD INSULATED

Colours:

730 Cornstalk / Dark Gum, 990 Black / Black Gum

Sizes:

5F,5.5F,6F,6.5F,7F,7.5F,8F,8.5F,9F,9.5F,10F,11F

Description:

Sitting on a rugged work boot sole The Sherwood Insulated features an EVA rand providing extra insulation and comfort. This is a clean, classic and sleek boot, crafted in waterproof leathers with a medial zipper, a warm faux-fur lining, and also featuring Primaloft insulation in order to keep your feet warm, dry and comfortable.

USD \$165

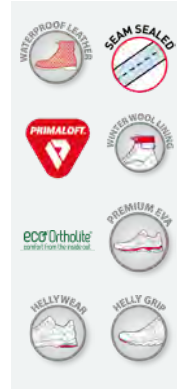

11651 W ODIN PRIMALOFT HIKER HT

Colours:

990 Black / Charcoal / Gunmetal

Sizes:

5.5F,6F,6.5F,7F,7.5F,8F,8.5F,9F,9.5F,10F

Description:

Looking for the best comfort, warmth and protection whether in the city or up in the mountain? The Odin Primaloft Hiker will provide you with a warm, insulated and waterproof upper, and a high performance dual-density EVA midsole. Our HellyGrip outsole rubber compound offer great traction in all terrain and conditions.

USD \$220

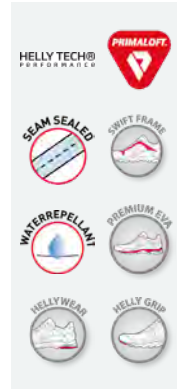

CASUAL BOOTS & SHOES

11517 W LOKE BOWRON LEATHER

Colours:

034 Camel / Fallen Rock / Pelican, 964 Charcoal / Quiet Shade / Shadow Blue

Sizes:

5.5F,6F,6.5F,7F,7.5F,8F,8.5F,9F,9.5F,10F

Description:

The Loke Bowron in full-grain waterproof leather and suede is a great outdoor classic. This versatile silhouette is a good companion on all types of trails; from the city to the forest.

USD \$120



11445 W FREMONT

USD \$170

Colours:

421 Lav Green / Beluga / Sperry Gum, 725 Honey Wheat / Beluga / Pale Gum, 990 Black / Black Gum

Sizes:

5F,5.5F,6F,6.5F,7F,7.5F,8F,8.5F,9F,9.5F,10F,11F

Description:

The Fremont boot is a reinvented must-have. This classic 6-inch rugged boot is lighter and more comfortable with the same stylish look and waterproof leather. It offers great comfort and protection for everyday outdoor tasks and is an absolute must-have for this winter season.

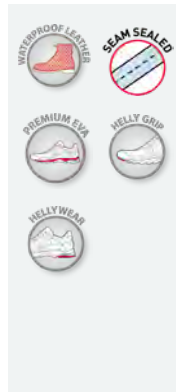

11255 W MARION

USD \$160

Colours:

421 Lav Green / Beluga / Castle Wall, 581 Graphite Blue / Castle Wal / Sperry Gum, 724 New Wheat / Castle Wall / Pale Gum / Sperry Gum, 741 Whiskey / Bison / Soccer Gum

Sizes:

5F,5.5F,6F,6.5F,7F,7.5F,8F,8.5F,9F,9.5F,10F,11F

Description:

The Marion boot is our womens exclusive 'yellow-boot'. It offers all the same ruggedness, element protection and winter traction as the male counterpart, just with a feminine twist. Crafted in beautiful, waterproof and silky nubuck with a seam-sealed construction and warm faux-fur lining enables you to keep your feet warm, dry and comfortable whilst looking your best.

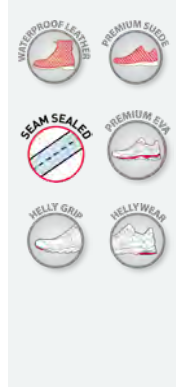

11511 W STOCKHOLM 2

USD \$130

Colours:

725 Honey Wheat / Cashew / Off White, 857 Pelican / Aluminum / Misty Rose, 990 Black / Grey Fog

Sizes:

5F,5.5F,6F,6.5F,7F,7.5F,8F,8.5F,9F,9.5F,10F,11F

Description:

Come rain or shine, these stylish sneaker-boots are the epitome of Scandinavian design. No winter is complete without it's fair share of sleet and snow and these warm, protective, comfortable and light-weight boots can tackle all conditions with ease. And the best part is that you'll look good whilst doing it.



11627 W TRINITY BOOT

USD \$150

Colours:

482 Beluga / Lav Green, 597 Navy / Wild Rose / Sperry Gum, 720 Fallen Rock / Aluminum

Sizes:

5F,5.5F,6F,6.5F,7F,7.5F,8F,8.5F,9F,9.5F,10F,11F

Description:

Soft, plush, stylish, yet fully weather protected. This premium waterproof suede boot feature a soft knitted collar for added comfort, and premium leather heel-cap and detailing.

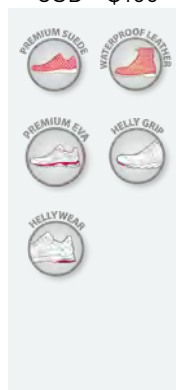

WOMEN'S FOOTWEAR

11612 W RICHMOND

Colours:

597 Navy / Black / Sperry Gum, 726 Honey Wheat / Coffee Bean / Sperry Gum, 857 Pelican / Cream / Light Gum

Sizes:

5F,5.5F,6F,6.5F,7F,7.5F,8F,8.5F,9F,9.5F,10F,11F

Description:

This demi-cut casual boot offers great cushioning, comfort and traction. The upper consist of waterproof nubuck leathers and hydrophobic treated textiles

USD \$125

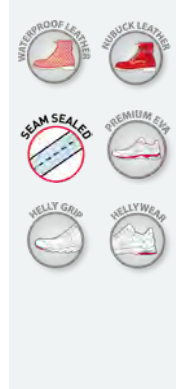

11623 W KAMBO 1877 BOOT

Colours:

421 Lav Green / Beluga / Aluminum, 597 Navy / Slate / Sperry Gum

Sizes:

5F,5.5F,6F,6.5F,7F,7.5F,8F,8.5F,9F,9.5F,10F,11F

Description:

The 1877 range celebrates our Scandinavian heritage, the oceans and the mountains, and through colors, graphics and design details The Kambo boot pays tribute to the old mountaineering boots of yesteryear.

USD \$130

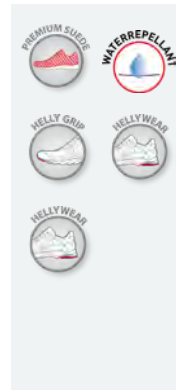

11663 W MIDSUND 3

Colours:

597 Navy, 971 Quiet Shade

Sizes:

5F,6F,7F,8F,9F,10F,11F

Description:

Helly Hansen has produced weather protective gear since 1877, and rubber boots have always been at the core of our business. These Midsund wellies for men effortlessly combine style, comfort and weather protection.

USD \$65

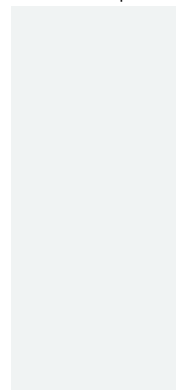

11661 W NORDVIK 2

USD \$80

Colours:

344 Essential Yellow, 597 Navy, 990 Black

Sizes:

5F,6F,7F,8F,9F,10F,11F

Description:

Helly Hansen has produced weather protective gear since 1877, and rubber boots have always been at the core of our business. The Women's Nordvik is a great option for casual use or as a companion down at the marina. These lower cut, lighter-weight boots effortlessly combine style, and comfort, whilst also featuring a flat, and siped outsole for great traction.

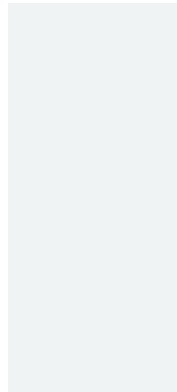

11664 W VEIERLAND 3

USD \$85

Colours:

482 Beluga, 597 Navy

Sizes:

5F,6F,7F,8F,9F,10F,11F

Description:

The Veierland 3 Women's rubber boots look great, yet no need to compromise on comfort, traction and protection. Fully waterproof fashion wellies.

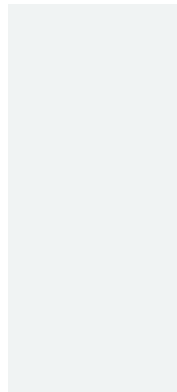



HELLY HANSEN TECH CLINIC

For the past 140 years Helly Hansen has been developing & testing its technologies together with professionals living and working in some of the world's toughest environments.

Their spirit, experiences and feedback are woven into every detail and every fiber of our garments. Ski patrollers, mountain professionals, offshore sailors, search and rescue professionals all rely on our products and technologies to keep them safe, protected and warm in some of the most challenging conditions known to man.

On the following pages you can read more about the technologies used in the gear that professionals know and trust.





WARM. DRY. COMFORTABLE.

Launched in the early 1970s, Lifa® is based on a yarn technology that has been tested and developed over the years. The key functions of Lifa® deliver both moisture management and insulation, moving moisture away from the skin, while transporting perspiration to the surface of the fabric, where it evaporates. In 2006 Lifa® was combined with non mulsed Merino wool to create the best performing base layer to date.

Lifa® is a hydrophobic fiber that prohibits the absorption of liquid. The Lifa® fibers are used on the first membrane layer of base layer garments, the layer nearest to the skin. When the first yarn layer is combined with an additional layer with hydrophilic (moisture absorbing) properties, the sweat from the body is moved away from the skin and transported to the second layer, where it is absorbed. This enables the consumer to stay warm, dry and comfortable.

LIFA® is an ultra-light weight base layer fabric that works perfectly in the autumn and winter. HH LIFA® delivers light insulation and moisture management through its 100% single layer Lifa® fibers.

The Lifa® technology works best when layered under another garment, as the more garments you wear, the further the sweat and moisture will be transported out of the fabric and away from your skin.



HOW LIFA® WORKS

LIFA® stay dry technology moves sweat away from your skin, keeping you warmer for longer

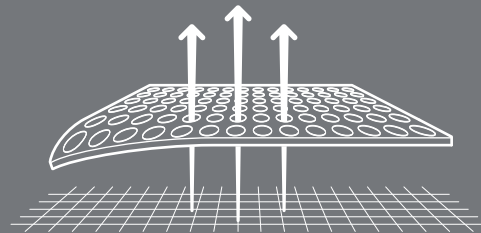

LIFA® ACTIVE is our best moisture management base layer that is great for light insulation all year round. Made from a light-weight, two layer fabric that is excellent in moving moisture away from the skin; it enables the user to feel warm and comfortable.

LIFA® ACTIVE can be worn as a single layer or can be layered under another garment.



LIFA® MERINO is a unique 2-in1 base layer that combines light-weight Lifa® fibers next to skin and an extremely soft Merino Wool exterior. The Lifa® fabric moves moisture away from skin while the merino wool exterior is excellent at insulating and maintaining warmth. This is our warmest baselayer and is recommended for any type of outdoor activities in the winter.

HH MERINO

Helly Hansen launched pure merino wool base layers a few years ago, delivering great all-day warmth and comfort for cold autumn and winter days

HH MERINO LIGHT and **MID** uses high quality, comfortable Merino Wool to deliver great warmth and comfort for colder days. This is our recommended and preferred base layer for daily activities with low intensity in the winter. HH Merino Light is our year-round pure merino wool product. HH Merino Light is made with a light weight merino fabric, and it delivers light weight insulation, breathability and great comfort, all day, all year. HH Merino Mid is our mid-weight, 200g merino wool baselayer that is ideal for colder days.



lifa^{loft}
INSULATION BY **PRIMALOFT**.

- LIGHTER. WARMER.



With increased warmth, lightweight insulation and superior moisture management properties, LifaLoft™ technology is an insulation revolution that will keep you warmer with less weight and bulk compared to traditional polyester insulation. Developed in cooperation with PrimaLoft®, LifaLoft™ is a combination of Lifa®'s unique insulation structure and PrimaLoft®'s extensive knowledge in synthetic insulation.

LIFA® + PRIMALOFT® PROPERTIES:

The unique hydrophobic properties of the Lifa® fibers deliver moisture management necessary for high endurance activities, whilst the PrimaLoft® structure offers high insulation and breathable performance insulation for all active pursuits.

LIFA® DETAILS:

LifaLoft™ insulation is based on Lifa® fiber technology that is engineered into a lightweight structure that traps more air than standard polyester, providing extra warmth; the fiber does not absorb water, making the insulation technology ideal for intense activities in variable winter or summer conditions

lifa[®] + PRIMALOFT.



lifa loft
INSULATION BY PRIMALOFT.

LIGHTWEIGHT WARMTH FOR ALL SEASONS
20% LIGHTER AND STILL WARMER THAN
STANDARD INSULATION.



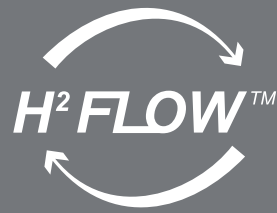

WARMER. COOLER. DRIER.

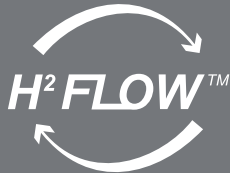

H²Flow™ allows you to control your body's temperature. The technology optimizes insulation, using air pockets or holes that store warmth from the body and, at the same time, allows you to control heat and airflow through ventilation zippers, enabling the cold air to enter and the warm air to exit.

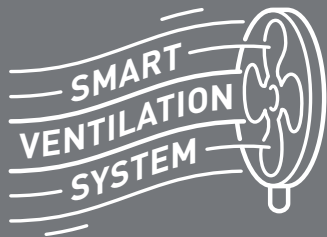

Negative or positive air space is created by adding or subtracting fabric on the inside of the garment to allow this extra air space to be filled with air heated up by the body. In both cases, the purpose is to create pockets of air in strategic areas of the body, trapped in these channels or spaces. The air contained in these pockets heats up from the body heat of the wearer, and keeps you warm.

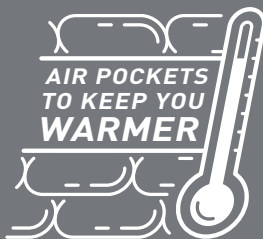

HOW H²FLOW™ WORKS

Ventilation zippers let cold air in if you get too warm. Air pockets or holes store warmth from your body, so all H²FLOW™ jackets have a high warmth to weight ratio

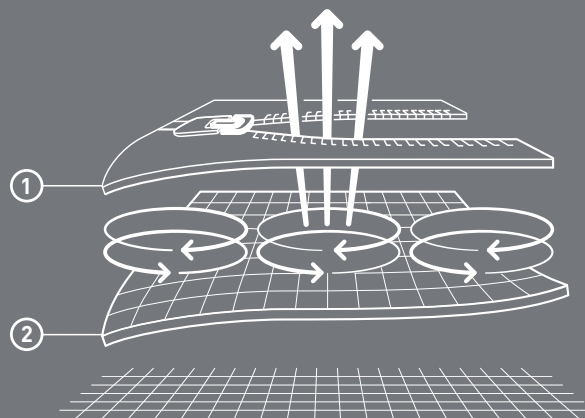

H²FLOW™ AIR FORCE VENTILATION

The evolution of our award-winning H2Flow™ Technology

Through the use of micro climate sensors, we have updated and improved our H2FLOW™ insulation technology by adding air force ventilation. This restructured evolution lets you control your body temperature with ease. Air is pushed through the system and forced to vent through the back panel, thus improving the exchange of warm humid air with cool dry air. The result is a warmer and more comfortable jacket.



HELLY TECH®

WATERPROOF. BREATHABLE. GUARANTEED.



Helly Tech® is constructed with Polymer Polyurethane (PU) based membranes and coating technologies. The PU membrane gives softness and stretch to the fabric, while the coating allows waterproofness and breathable qualities.

Helly Tech® is made either with Hydrophilic barrier membranes or Micro-porous membranes, depending on the end-use purpose of the fabric.



The Hydrophilic barrier works on an osmotic principle, keeping salts from entering and blocking the pores. The Micro-porous PU membranes are hydrophobic- “water hating” polymers. This membrane construction is responsible for the waterproofness of Helly Tech®, making the pores up to 20.000 times smaller than water droplets, while allowing breathability since the pores are up to 700 times larger than a water vapor molecule, allowing the evaporation of sweat and heat.



Helly Tech® is actually more than just a fabric – it is a combination of a DWR-treated outer fabric, a highly breathable and waterproof membrane, fully sealed seams and often a highly breathable inner fabric, mesh or lining.

The seams of the products are taped over with a waterproof ribbon and glue, preventing any water from entering the small gaps between the stitches of the seams.



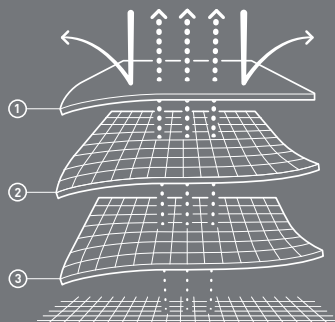

HOW HELLY TECH® WORKS

1. DWR treated outer fabric is windproof and water-repellent
2. Waterproof and breathable membrane or coating
3. Highly breathable inner fabric, mesh or lining

THERE ARE NUMEROUS TYPES OF HELLY TECH® FABRICS. THE MAIN DIFFERENTIATOR IS THE NUMBER OF PLYS (OR LAYERS) THE FABRIC IS BUILT FROM.

HELLY TECH® PROFESSIONAL

Extremely waterproof and breathable designs and constructions. For highly aerobic, extremely wet or unusually long-lasting activities in extremely harsh conditions.

HELLY TECH® PERFORMANCE

Highly waterproof and extra breathable sport specific designs and constructions. For a wide range of high performance outdoor activities during highly challenging, changing and unpredictable weather conditions.

HELLY TECH® PROTECTION

Fully waterproof, windproof and breathable fabrics and constructions. For all situations and weather conditions where protection from the elements is needed.

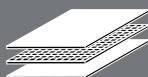

3 PLYCONSTRUCTION

Outer fabric + membrane and inner fabric bonded together for lightweight, quick drying and durability.



2,5 PLYCONSTRUCTION

Outer fabric + membrane or coating bonded together with protective print on the inside for extreme lightweight and packability

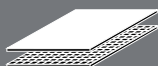

2 PLYCONSTRUCTION

Outer fabric + membrane or coating bonded together for breathable waterproofness, protected by inside lining or mesh adding warmth and comfort





HELOX

Since 1949, Helox has been an important step in Helly Hansens rainwear history. The transition from oil garments to plastic started. The very successful Helox garments made from PVC was launched, giving Helly Hansen a head start on the competition due to extensive material research abroad. The Norwegian delegation all wore Helox during the 1952 Olympic Games in Helsinki.



PU REPAIR KIT

The cabin tradition of Norway means that many old garments are never thrown out, but are instead stashed away at the cabin to avoid hauling clothes back and forth. There is therefore huge potential for providing a simple yet effective product which would bring these garments back to life.

As well as being provided with each new garment, the repair kit will be sold separately encouraging consumers to repair old garments as opposed to buying new ones.

The repair kit can be attached either at the neck loop, on an outside pocket, or on the CF zip. Keeping it separate from the hangtag will draw attention to it.



HELOX

PU REPAIR KIT

HH



1. CUT THE PATCH TO THE REQUIRED SIZE
2. SET IRON TO WOOL SETTING (148°C /300°F).
3. LAY THE REPAIR PATCH SHINY SIDE DOWN ONTO THE OUTSIDE OF THE DAMAGED AREA.
4. LAY A DISH CLOTH ONTOP OF THE PATCH.
5. HOLD THE IRON ON THE DISH CLOTH FOR 15 SECONDS.
6. REMOVE IRON AND DISH CLOTH. THE PATCH SHOULD HAVE FULLY ADHERED TO THE PU.
7. REPEAT THIS PROCESS FROM THE INNER SIDE TO GUARANTEE FULL WATERTIGHTNESS.

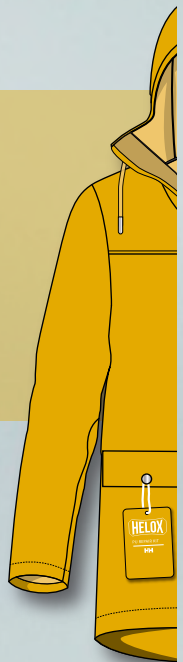



3-IN-1 SYSTEM

A combination of a light insulator jacket and a waterproof shell. Together, they are a versatile design that allows you to enjoy and adjust to all weather conditions



10-15°C

Choose the insulator for crisp and dry weather.

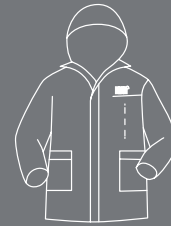

10-15°C

Use the waterproof shell in warm and wet weather.



-10-5°C

Combine the two for full protection in cold and wet weather.





LIFE POCKET™

LIFE POCKET™

A pocket engineered to preserve your personal electronics' battery life span. Scientifically tested and proven by engineers to extend the battery life of your mobile phone or action camera in cold environments. Through thermal resistant materials and an innovative construction, the Life Pocket™ stays 2 times warmer than a regular ski jacket pocket.

LIFE POCKET +™

A pocket engineered to preserve your personal electronics' battery life span. Scientifically tested and proven by engineers to extend the battery life of your mobile phone or action camera in cold environments. Through the use of one of the best insulation materials available, PrimaLoft® Gold Insulation Aerogel, and an innovative construction, the Life Pocket™ stays 3 times warmer than a regular ski jacket pocket.

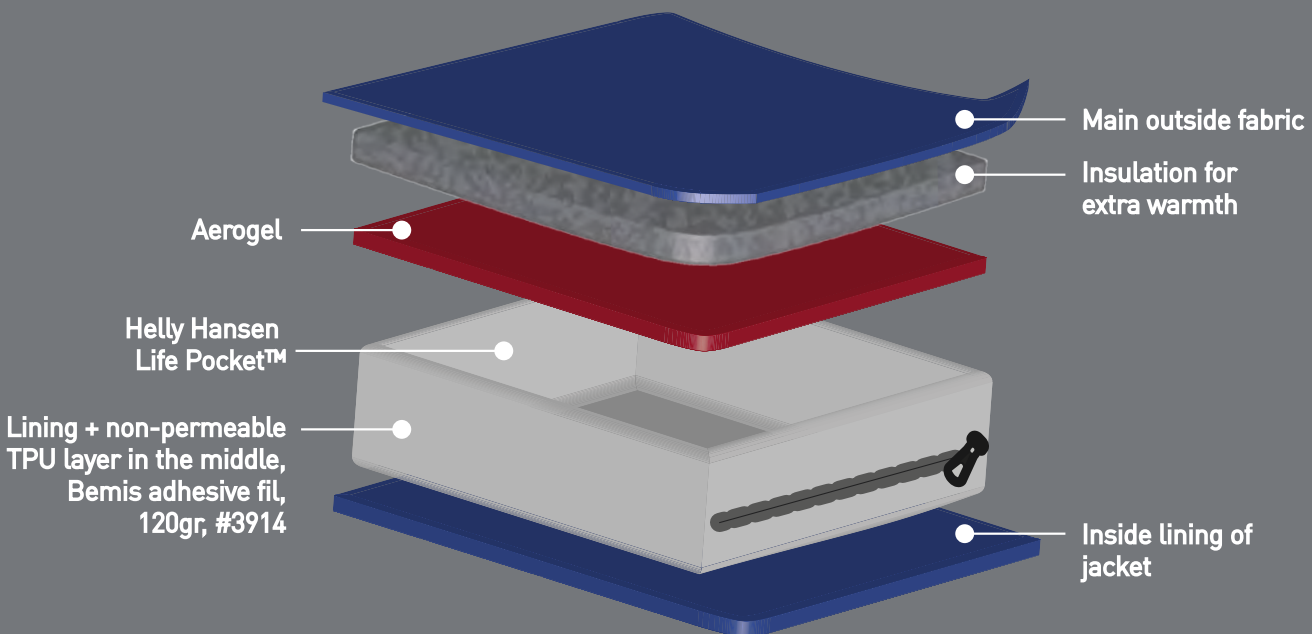

HELLY HANSEN TECH PARTNERS



Lavalan is designed as a natural, environmentally friendly alternative to the synthetic wadding normally used inside quilted garments.



The world's best down alternative.

PrimaLoft® is a synthetic insulation technology, offering superior thermal properties with excellent water repellency. It is made up of ultra-fine fibers that form air pockets to trap heat inside. Additional feature of the ultra-fine fiber is super softness.



ALLIED

Advanced down technologies.

Natural goose down is considered to be the single best insulating material available, due to its lightweight, compressibility and heat retention. Allied Down supplies its customers with the finest quality down and feathers on the market.



Little parts, big difference.

High quality zippers for all purposes. YKK® is a Japanese company founded in 1934. Today, their products are sold globally and YKK® is reputed as the industry leader for quality and innovative zippers and closure.



Soft. Light: Surprisingly strong.
A high-tech, lightweight and super soft fabric which dries x8 quicker than cotton.



The cornerstone of thermal insulating materials. We work extensively with Polartec®, a famous manufacturer of lightweight and warm fleece, which is known for performance, durability and aesthetics. Main benefits for using Polartec® are warmth without high additional weight, high breathability, packable and fast drying.



Elemental protection.
Dry, comfortable and lightweight construction. The benchmark for durable yet lightweight fabrics throughout the outdoor industry.



Recco® Technology makes you searchable for organized rescue in the event of an avalanche accident. The system requires no training and no batteries to function, meaning it is always "on" and ready. RECCO® reflectors do not prevent avalanches nor do they guarantee location or survival in the event of a burial.

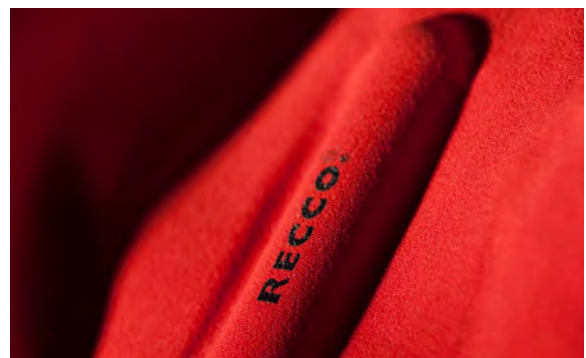

MEASUREMENTS / SIZES

MEN BODY MEASUREMENTS

Sizes		▼ Bodylength	▼ Chest	▼ Waist	▼ Hip	▼ Inseam	▼ CB Sleeve
XXS	cm	164 - 168	86 - 90	72 - 76	86 - 90	76 - 78	77 - 79
	inches	64,5 - 66	34 - 35,5	28,5 - 30	34 - 35,5	30 - 30,5	30,5 - 31
XS	cm	168 - 172	90 - 94	76 - 80	90 - 94	78 - 80	79 - 81
	inches	66 - 67,5	35,5 - 37	30 - 31,5	35,5 - 37	30,5 - 31,5	31 - 32
S	cm	172 - 176	94 - 100	80 - 86	94 - 100	80 - 82	81 - 84
	inches	67,5 - 69	37 - 39,5	31,5 - 34	37 - 39,5	31,5 - 32	32 - 33
M	cm	176 - 180	100 - 104	86 - 92	100 - 104	82 - 84	84 - 84
	inches	69 - 71	39,5 - 41	34 - 36	39,5 - 41	32 - 33	33 - 34
L	cm	180 - 184	104 - 112	92 - 98	104 - 112	84 - 86	87 - 90
	inches	71 - 72,5	41 - 44	36 - 38,5	41 - 44	33 - 34	34 - 35,5
XL	cm	184 - 188	112 - 120	98 - 106	112 - 120	86 - 88	90 - 93
	inches	72,5 - 74	44 - 47	38,5 - 41,5	44 - 47	34 - 34,5	35,5 - 36,5
XXL	cm	188 - 192	120 - 128	106 - 114	120 - 128	88 - 89,5	93 - 96
	inches	74 - 75,5	47 - 50,5	41,5 - 45	47 - 50,5	34,5 - 35,5	36,5 - 38
3XL	cm	192 - 195	128 - 136	114 - 122	128 - 136	89,5 - 91	96 - 98
	inches	75,5 - 77	50,5 - 53,5	45 - 48	50,5 - 53,5	35 - 36	38 - 38,5
4XL	cm	192-195	136 -144	122-130	136-144	89,5-90	96-98
	inches	75,5-77	53,5 - 56,5	48-51	53,5-56,5	35-35,5	38-38,5
5XL	cm	192-195	144-152	130-138	144-152	89,5-90	96-98
	inches	75,5-77	56,5-60	51-54,5	56,5-60	35-35,5	38-38,5
6XL	cm	192-195	152-160	138-146	152-160	89,5-90	96-98
	inches	75,5-77	60-63	54,5-57,5	60-63	35-35,5	38-38,5

WOMAN BODY MEASUREMENTS

Sizes		▼ Bodylength	▼ Chest	▼ Waist	▼ Hip	▼ Inseam	▼ CB Sleeve
XS	cm	158 - 162	82 - 86	66 - 70	90 - 94	75 - 77	74 - 76
	inches	62 - 64	32 - 34	26 - 27,5	35,5 - 37	29,5 - 30,5	29 - 30
S	cm	162 - 166	86 - 90	70 - 74	94 - 98	77 - 79	76 - 78
	inches	64 - 65,5	34 - 35,5	27,5 - 29	37 - 38,5	30,5 - 31	30 - 31
M	cm	166 - 170	90 - 96	74 - 80	98 - 104	79 - 81	78 - 81
	inches	35,5 - 67	35,5 - 38	29 - 31,5	38,5 - 41	31 - 32	31 - 32
L	cm	170 - 174	96 - 102	80 - 86	104 - 110	81 - 83	81 - 84
	inches	67 - 68,5	38 - 40	31,5 - 34	41 - 43,5	32 - 32,5	32 - 33
XL	cm	174 - 178	102 - 110	86 - 94	110 - 118	83 - 85	84 - 86
	inches	68,5 - 70	40 - 43,5	34 - 37	43,5 - 46,5	32,5 - 33,5	33 - 34
XXL	cm	178 - 180	110 - 116	94 - 102	118 - 124	85 - 87	86 - 88
	inches	70 - 71	43,5 - 45,5	37 - 40	46,5 - 49	33,5 - 34	34 - 34,5
3XL	cm	180-185	118-126	102-110	124-132	85-87	86-89
	inches	70-71	46,5-49,5	40-43,5	49-52	33,5-34	34-35
4XL	cm	180-185	126-134	110-118	132-140	85-87	86-89
	inches	70-71	49,5-53	43,5-46,5	52-55	33,5-34	34-35
5XL	cm	180-185	134-142	118-126	140-148	85-87	86-89
	inches	70-71	53-56	46,5-49,5	55-58	33,5-34	34-35
6XL	cm	180-185	142-150	126-134	148-156	85-87	86-89
	inches	70-71	56-59	49,5-53	58-61,5	33,5-34	34-35

JUNIOR / KIDS

Sizes		▼ Bodylength	▼ Chest	▼ Waist	▼ Hip	▼ Inseam	▼ CB Sleeve
86 / 1 yr	cm	83 - 89	52,5 - 53,5	50 - 51	55 - 57	32 - 36	42 - 45
	inches	32,5 - 35	20,5 - 21	19,5 - 20	21,5 - 22,5	12,5 - 14	16,5 - 17,5
92 / 2 yr	cm	89 - 95	53,5 - 55	51 - 52	57 - 59	36 - 38	45 - 48
	inches	35 - 37,5	21 - 21,5	20 - 20,5	22,5 - 23	14 - 15	17,5 - 19
98 / 3 yr	cm	95 - 101	55 - 57	52 - 54	59 - 61	38 - 42	48 - 51
	inches	37,5 - 40	21,5 - 22,5	20,5 - 21	23 - 24	15 - 16,5	19 - 20
104 / 4 yr	cm	101 - 107	57 - 59	54 - 56	61 - 63	42 - 46	51 - 53,5
	inches	40 - 42	22,5 - 23	21 - 22	24 - 25	16,5 - 18	20 - 21
110 / 5 yr	cm	107 - 113	59 - 61	56 - 58	63 - 65	46 - 49	53,5 - 56
	inches	42 - 44,5	23 - 24	22 - 23	25 - 25,5	18 - 19	21 - 22
116 / 6 yr	cm	113 - 119	61 - 63	58 - 60	65 - 67	49 - 53	56 - 58,5
	inches	44,5 - 47	24 - 25	23 - 23,5	25,5 - 26,5	19 - 21	22 - 23
122 / 7 yr	cm	119 - 125	63 - 65	60 - 62	67 - 69	53 - 57	58,5 - 61
	inches	47 - 49	25 - 25,5	23,5 - 24,5	26,5 - 27	21 - 22,5	23 - 24
128 / 8 yr	cm	125 - 131	65 - 67	62 - 64	69 - 71	57 - 60	61 - 63,5
	inches	49 - 51,5	25,5 - 26,5	24,5 - 25	27 - 28	22,5 - 23,5	24 - 25
134 / 9 yr	cm	131 - 137	67 - 71	64 - 67	71 - 75	60 - 64	63,5 - 67
	inches	51,5 - 54	26,5 - 28	25 - 26,5	28 - 29,5	23,5 - 25	25 - 26,5
140 / 10 yr	cm	137 - 142	71 - 74	67 - 71	75 - 78	64 - 68	67 - 71,5
	inches	54 - 56	28 - 29	26,5 - 28	29,5 - 30,5	25 - 27	26,5 - 28
152 / 12 yr	cm	142 - 152	74 - 79	71 - 74	78 - 84	68 - 72	71,5 - 76,5
	inches	56 - 60	29 - 31	28 - 29	30,5 - 33	27 - 28,5	28 - 30
164 / 14 yr	cm	152 - 164	79 - 85	74 - 77	84 - 90	72 - 76	76,5 - 81,5
	inches	60 - 64,5	31 - 33,5	29 - 30,5	33 - 35,5	28,5 - 30	30 - 32
176 / 16 yr	cm	164 - 176	85 - 91	77 - 79	90 - 94	76 - 80	81,5 - 86,5
	inches	64,5 - 69	33,5 - 35,5	30,5 - 31	35,5 - 37	30 - 31,5	32 - 34

SIZE GUIDE

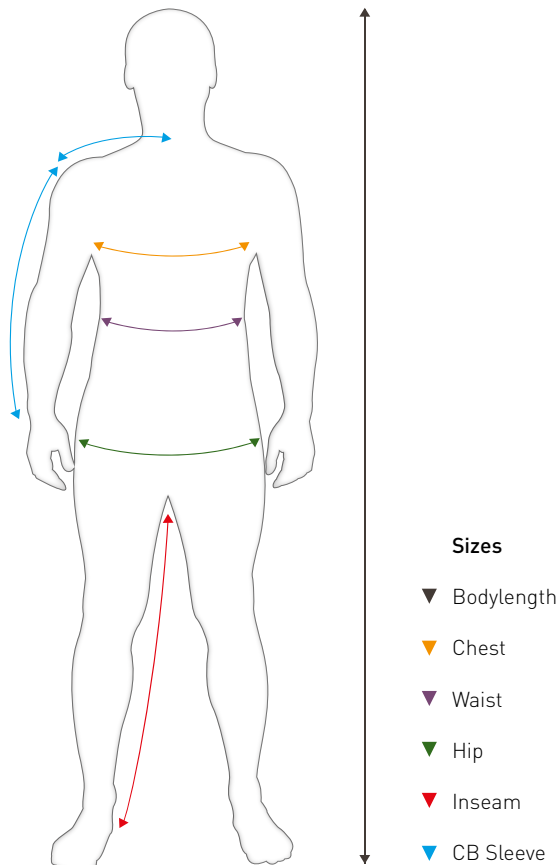

FOOTWEAR sizes

W'S STANDARD/ COMPLETE (SHOES/BOOTS/LIFESTYLE)	EU	US	EU	US	EU	US	EU	US	EU	US
	36	5,5	37	6	37,5	6,5	38	7	38,7	7,5
UK SIZING	UK	3,5	UK	4	UK	4,5	UK	5	UK	5,5
M'S STANDARD/ COMPLETE (SHOES/BOOTS/LIFESTYLE)	EU	US	EU	US	EU	US	EU	US	EU	US
	40	7	40,5	7,5	41	8	42	8,5	42,5	9
UK SIZING	UK	6,5	UK	7	UK	7,5	UK	8	UK	8,5
W'S RUBBER BOOTS (MIDSUND/VEIERLAND)	EU	US	EU	US	EU	US	EU	US	EU	US
	35/36	5	37	6	38	7	39	8	40	9
UK SIZING	UK	3	UK	4	UK	5	UK	6	UK	7
M'S RUBBER BOOTS (MIDSUND)	EU	US	EU	US	EU	US	EU	US	EU	US
	40	7	41	8	42	9	43	10	44	11
UK SIZING	UK	6	UK	7	UK	8	UK	9	UK	10
W'S SAILING BOOTS (AEGIR OCEAN BOOT)	EU	US	EU	US	EU	US	EU	US	EU	US
	36	5,5	37	6	38	7	39	8	40	8,5
UK SIZING	UK	4	UK	5	UK	6	UK	6,5	UK	7
M'S SAILING BOOTS (AEGIR OCEAN BOOT)	EU	US	EU	US	EU	US	EU	US	EU	US
	40	7,5	41	8	42	8,5	43	9	44	10
UK SIZING	UK	7	UK	7,5	UK	8,5	UK	9	UK	10
JUNIOR/KIDS RUBBER BOOTS (JK MIDSUND)	EU	US	EU	US	EU	US	EU	US	EU	US
	25	8	26	9	27	10	28	11	29	12

MEASUREMENT - SIZES

SOCKS

EURO	36-39	39-41	40-42	42-44	44-47
WOMEN FEMME	5-8	8-9	8,5-10		
MENS HOMME	4-7	7-8	7-10	10-11	11-14
KIDS	23-25				
JUNIOR	26-28	29-31	35-35		



EU	US	EU	US	EU	US	EU	US	EU	US
39,3	8	40	8,5	40,5	9	41	9,5	42	10
UK	6	UK	6,5	UK	7	UK	7,5	UK	8

EU	US	EU	US	EU	US	EU	US	EU	US	EU	US	EU	US
43	9,5	44	10	44,5	10,5	45	11	46	11,5	46,5	12	48	13
UK	9	UK	9,5	UK	10	UK	10,5	UK	11	UK	11,5	UK	12,5

EU	US	EU	US
41	10	42	11
UK	8	UK	9

EU	US	EU	US
45/46	12	47	13
UK	11	UK	12

EU	US	EU	US
41	9	42	10
UK	7,5	UK	8

EU	US	EU	US	EU	US
45	11	46	12	47	13
UK	11	UK	12	UK	12,5

EU	US	EU	US	EU	US	EU	US	EU	US	EU	US
30	13	31	1	32	2	33	3	34	4	35	5

GLOVES

SIZE	INCHES	CM
S	7	18
M	7,5-8	20
L	8,5-9	23
XL	9,5-10	25



INDEX ALPHABETICAL

53584	ACTIVE HOODED MIDLAYER JACKET.....	72	67300	HH BRAND CAP.....	182	67352	JR SWIFT HT GLOVE.....	180
31706	ÆGIR OCEAN DRY SUIT.....	66	67155	HH FLATBRIM TRUCKER CAP.....	182	67346	JR SWIFT HT MITTEN.....	181
34005	ÆGIR OCEAN DRY TOP.....	65	67406	HH FLEECE BEANIE.....	174	41723	JR TORNADO JACKET.....	150
34113	ÆGIR OCEAN JACKET.....	64	67332	HH FLEECE TOUCH GLOVE LINER.....	179	41730	JR URBAN PUFFY PARKA.....	152
34006	ÆGIR OCEAN SMOCK.....	65	67374	HH LIGHT DRY BAG 12L.....	189	41735	JR URBAN RAIN JACKET.....	154
34007	ÆGIR OCEAN TROUSERS.....	66	67375	HH LIGHT DRY BAG 20L.....	189	41721	JR WHITEOUT JACKET.....	149
33869	ÆGIR RACE JACKET.....	64	67372	HH LIGHT DRY BAG 3L.....	188	51806	JUELL PILE JACKET.....	52
33871	ÆGIR RACE SALOPETTE.....	64	67373	HH LIGHT DRY BAG 7L.....	188	65598	JUNIPER 3.0 JACKET.....	18
33976	ÆGIR RACE SMOCK LIGHT.....	64	34000	HH LOGO CREW SWEAT.....	76	67457	JUNIPER GLOVE.....	177
67461	ALL MOUNTAIN GLOVE.....	176	34163	HH LOGO FULL ZIP HOODIE.....	75	40360	K BERGEN PU RAINSET.....	163
65551	ALPHA 3.0 JACKET.....	17	33977	HH LOGO HOODIE.....	75	40482	K CHAMP 1/2 ZIP MIDLAYER.....	164
65667	ALPHA LIFALOFT JACKET.....	17	33979	HH LOGO T-SHIRT.....	76	40481	K CHAMP REVERSIBLE JACKET.....	164
65761	ALPHA LIFALOFT™ PANT.....	19	51811	HH MERINO HOODED JACKET.....	53	40362	K DAYBREAKER 2.0 JACKET.....	164
67469	ALPINE SOCK MEDIUM.....	181	48356	HH MERINO MID 1/2 ZIP.....	45	41084	K DAYBREAKER FLEECE PANT.....	165
67470	ALPINE SOCK TECHNICAL.....	181	49402	HH MERINO MID GRAPHIC CREW.....	46	40483	K DAYBREAKER HOODIE.....	165
67468	ALPINE SOCK WARM.....	181	48355	HH MERINO MID LS.....	46	48610	K HH LIFA MERINO SET.....	165
34074	ARCTIC OCEAN HYBRID INSULATOR.....	67	48471	HH MERINO MID PANT.....	46	40494	K HH MERINO MID BOTTOMS.....	166
34093	ARCTIC OCEAN PARKA.....	66	67306	HH MERINO NECK.....	175	49312	K HH MERINO MID SET.....	165
34059	ARCTIC OCEAN PUFFY JACKET.....	67	67963	HH NECK.....	176	40493	K HH MERINO MID TOP.....	166
34063	ARCTIC OCEAN WINDPROOF PILE.....	67	67370	HH OCEAN DRY BAG L.....	188	40374	K LEGEND INS JACKET.....	161
34062	ARCTIC OCEAN WINDPROOF SWEATER.....	67	67371	HH OCEAN DRY BAG XL.....	188	67428	K MERINO BEANIE.....	166
34095	ARCTIC SHORE SWEATER.....	68	33996	HH QD CARGO PANT.....	75	40384	K MOSS PU RAINSET.....	163
65715	AXAMER PUFFY JACKET.....	14	54154	HH QD CARGO SHORTS 11.....	75	40477	K OSLO PARKA.....	162
53167	BARENTS PARKA.....	58	67381	HH RACING BAG.....	189	67162	K OUTLINE BEANIE.....	166
57502	BRAND BEANIE.....	170	67003	HH SEAMLESS CAP.....	183	40342	K RIDER 2 INS BIB.....	162
67195	BUSINESS BEANIE 2.....	174	48365	HH TECH 1/2 ZIP.....	48	40393	K RIDER 2 INS JACKET.....	160
67451	CHAMPOW BEANIE.....	174	48364	HH TECH CREW.....	48	40379	K SHELTER JACKET.....	163
67405	CHILL KNIT BEANIE.....	173	48363	HH TECH T-SHIRT.....	48	41026	K SHELTER PANT.....	163
53145	CHILL PARKA.....	57	67363	HH WEBBING BELT.....	183	40479	K STORM REVERSIBLE INSULATOR.....	164
62923	CLASSIC CHECK LS SHIRT.....	39	67809	HH WINTER BEANIE.....	173	40473	K TINDEN INS JACKET.....	160
67450	COZY BEANIE.....	172	67403	HH WOOL CAP.....	182	40470	K TINDEN SKISUIT.....	160
67160	CREW CAP.....	183	62897	HOLMEN 5 POCKET PANT.....	37	40366	K VERTICAL INS BIB PANT.....	161
33875	CREW HOODED JACKET.....	70	63010	HOVIN INSULATED JACKET.....	35	40478	K VIK PUFFY JACKET.....	162
33874	CREW HOODED MIDLAYER JACKET.....	70	54213	HP 1/2 ZIP PULLOVER.....	73	11622	KAMBO 1877 BOOT.....	198
54344	CREW INSULATOR JACKET.....	71	34043	HP FLEECE JACKET.....	72	65749	KICKINGHORSE JACKET.....	22
30263	CREW JACKET.....	70	34044	HP OCEAN FZ HOODIE.....	72	67000	KITSILANO BACKPACK.....	187
30253	CREW MIDLAYER JACKET.....	70	34040	HP RACING JACKET.....	69	63013	KOLSAAS FLEECE JACKET.....	36
34004	CREW POLO.....	74	34041	HP RACING MIDLAYER JACKET.....	69	63014	KULPEN PRINTED FLEECE.....	36
54412	CREW SOFTSHELL JACKET.....	71	34123	HP SHORE LS POLO.....	73	67460	LEATHER MIX GLOVE.....	176
34142	CREW SWEATSHIRT.....	72	53324	HUDSON PARKA.....	57	49388	LIFA ACTIVE 1/2 ZIP.....	46
30270	CREW VEST.....	71	63017	HYGGEN LIGHT HOODIE.....	39	49389	LIFA ACTIVE CREW.....	47
67145	DAWN PATROL GLOVE.....	178	63019	HYGGEN LS HENLEY.....	40	49390	LIFA ACTIVE PANT.....	47
50844	DAYBREAKER 1/2 ZIP FLEECE.....	54	65717	ICON 4.0 SONIC WELDED PANT.....	16	65605	LIFA LOFT HYBRID INSULATOR JACKET.....	24
51598	DAYBREAKER FLEECE JACKET.....	53	65713	ICON 4.0 SONIC WELDED STRETCH JACKET.....	14	49359	LIFA MERINO HEAVYWEIGHT 1/2 ZIP.....	42
51742	DAYBREAKER FLEECE PANT.....	54	53542	JPN 3IN1 PARKA.....	55	49360	LIFA MERINO HEAVYWEIGHT CREW.....	42
51831	DAYBREAKER FLEECE VEST.....	54	53544	JPN CORD JACKET.....	55	49361	LIFA MERINO HEAVYWEIGHT PANT.....	42
51893	DAYBREAKER LOGO HOODIE.....	53	53566	JPN PUFFY JACKET.....	55	49369	LIFA MERINO LIGHTWEIGHT 1/2 ZIP.....	45
67386	DUBLIN 2.0 BACKPACK.....	186	53545	JPN QUILTED 1/2 ZIP HOODIE.....	56	49370	LIFA MERINO LIGHTWEIGHT CREW.....	45
53117	DUBLINER INSULATED JACKET.....	61	53408	JPN RAIN JACKET.....	56	49368	LIFA MERINO LIGHTWEIGHT HOODIE.....	44
53510	DUBLINER INSULATED LONG JACKET.....	61	49403	JR LIFA MERINO MIDWEIGHT SET.....	157	49371	LIFA MERINO LIGHTWEIGHT PANT.....	45
62643	DUBLINER JACKET.....	61	41726	JR BLAZE JACKET.....	150	49363	LIFA MERINO MIDWEIGHT 1/2 ZIP.....	42
62652	DUBLINER PANT.....	61	41737	JR CHAMP 1/2 ZIP MIDLAYER.....	155	49367	LIFA MERINO MIDWEIGHT 3/4 PANT.....	44
65772	ELEVATION INFINITY SHELL JACKET.....	20	41736	JR CHAMP REVERSIBLE JACKET.....	155	49364	LIFA MERINO MIDWEIGHT CREW.....	44
65746	ELEVATION SHELL 3.0 JACKET.....	20	41689	JR CYCLONE JACKET.....	148	49362	LIFA MERINO MIDWEIGHT HOODIE.....	43
65751	ELEVATION SHELL 3.0 PANT.....	22	41661	JR DAYBREAKER 2.0 JACKET.....	155	49366	LIFA MERINO MIDWEIGHT PANT.....	44
62952	ESSENTIAL CANVAS PANT.....	34	41688	JR DAYBREAKER HOODIE.....	156	65702	LIFALOFT FULL ZIP INSULATOR.....	25
62934	F2F COTTON HOODIE.....	39	41681	JR DIAMOND JACKET.....	148	65604	LIFALOFT HOODED INSULATOR JACKET.....	24
62933	F2F COTTON SWEATER.....	39	41727	JR DIVINE JACKET.....	150	65674	LIFALOFT HOODED STRETCH INSULATOR.....	24
51849	FEATHER PILE JACKET.....	52	40330	JR DUBLINER PANT.....	154	65603	LIFALOFT INSULATOR JACKET.....	24
65670	FIRSTTRACK LIFALOFT™ JACKET.....	21	41616	JR FELIX PARKA.....	153	65606	LIFALOFT INSULATOR VEST.....	25
34124	FJORD LONG SLEEVE.....	74	41720	JR FLY HIGH INS SKI SUIT.....	148	62920	LIFALOFT™ INSULATED FLANNEL SHIRT.....	38
67448	FLAG BEANIE.....	172	41741	JR GRAPHIC HOODIE.....	156	63015	LILLO SWEATER.....	37
65740	FREEWAY JACKET.....	18	41742	JR GRAPHIC LS T-SHIRT.....	156	38791	LOGO CAP.....	183
11632	GAMVIK.....	194	41743	JR GRAPHIC T-SHIRT.....	156	67452	LOGO CUFF BEANIE.....	173
11649	GARIBALDI PRIMALOFT BOOT.....	194	48647	JR HH LIFA ACTIVE SET.....	158	67188	LOKE BACKPACK.....	187
65747	GARIBALDI 2.0 JACKET.....	21	26665	JR HH LIFA SET.....	158	11516	LOKE BOWRON LEATHER.....	196
65758	GARIBALDI 2.0 PANT.....	23	41748	JR HH MERINO MID BOTTOMS.....	157	62252	LOKE JACKET.....	34
11422	GARIBALDI V3.....	194	49311	JR HH MERINO MID SET.....	157	62265	LOKE PANTS.....	34
11157	GERTON.....	196	41747	JR HH MERINO MID TOP.....	157	67439	MARINE BAG.....	190
67454	GLACIER GLOVE.....	177	41733	JR INFINITY INSULATOR JACKET.....	152	67433	MARINE TOTE.....	189
65743	GRAVITATION JACKET.....	19	41612	JR ISFJORD DOWN MIX JACKET.....	152	51802	MARKA WOOL SWEATER.....	53
63009	GREFSEN 2L SHELL JACKET.....	35	41606	JR LEGENDARY PANT.....	151	63011	MEYER INSULATED JACKET.....	35
67442	H/H SCOUT DUFFEL L.....	185	41683	JR LIFALOFT INS JACKET.....	151	63012	MEYER INSULATED VEST.....	35
67441	H/H SCOUT DUFFEL M.....	185	41731	JR LUCA PUFFY PARKA.....	153	11662	MIDSUND 3.....	199
67440	H/H SCOUT DUFFEL S.....	185	41685	JR MAYA PARKA.....	154	11624	MONTESANO BOOT.....	197
67443	H/H SCOUT DUFFEL XL.....	186	41674	JR MOSS JACKET.....	154	53340	MOSS INSULATED RAIN COAT.....	62
67444	H/H SCOUT WASH BAG.....	186	41675	JR MOSS PANT.....	155	53267	MOSS JACKET.....	63
68084	HH LIFA MERINO GLOVE LINER.....	179	41729	JR NO LIMITS 2.0 PANT.....	151	53268	MOSS PANT.....	63
48305	HH LIFA PANT.....	47	41732	JR RADICAL PUFFY JACKET.....	153	53265	MOSS RAIN COAT.....	63
48800	HH LIFA STRIPE CREW.....	47	41722	JR SAPPHIRE JACKET.....	149	67083	MOUNTAIN BEANIE FLEECE LINED.....	172
67413	HH ADVENTURE BELT.....	182	41740	JR SUMMIT BIB PANT.....	151	62976	NORD GRAPHIC CREW SWEATSHIRT.....	41

62977	NORD GRAPHIC LONGSLEEVE T-SHIRT	41	65716	TRICOLORE INSULATED JACKET	14	33891	W CREW HOODED MIDLAYER JACKET	140
62975	NORD GRAPHIC PULL OVER HOODIE	41	65720	TRICOLORE KNITTED SWEATER	15	34071	W CREW INSULATOR JACKET	140
62978	NORD GRAPHIC T-SHIRT	41	65719	TRICOLORE QUILTED INSULATOR JACKET	15	34072	W CREW INSULATOR VEST	141
11660	NORDVIK 2	198	53491	TROMSOE PARKA	58	30297	W CREW JACKET	139
63042	ODDEN STRIPE KNIT SWEATER	36	11536	TUNDRA CWB 2	195	30317	W CREW MIDLAYER JACKET	139
62938	ODIN 9 WORLDS 2.0 JACKET	28	65745	ULLR CHUGACH POWDER SUIT	20	53055	W CREW PIQUE 2 POLO	141
67417	ODIN GLOVES	176	67154	URBAN CUFF BEANIE	173	34143	W CREW SWEATSHIRT	141
63046	ODIN INFINITY SHELL JACKET	26	53496	URBAN HOODED LINER	59	33984	W CREW TECH POLO	141
62997	ODIN LIFALOFT DOWN HYBRID JACKET	28	53495	URBAN LINER	59	30290	W CREW VEST	140
62939	ODIN LIGHT 3D SHELL JACKET	28	53181	URBAN LONG JACKET	58	50845	W DAYBREAKER 1/2 ZIP FLEECE	124
62902	ODIN MOUNTAIN 3L SHELL BIB PANT	26	53416	URBAN RAIN JACKET	60	51599	W DAYBREAKER FLEECE JACKET	124
62901	ODIN MOUNTAIN 3L SHELL JACKET	26	53509	UTILITY INSULATED PARKA	60	51743	W DAYBREAKER FLEECE PANT	124
62903	ODIN MOUNTAIN SOFTSHELL JACKET	27	53511	UTILITY INSULATED RAIN JACKET	60	51894	W DAYBREAKER LOGO HOODIE	124
62904	ODIN MOUNTAIN SOFTSHELL PANT	27	53415	UTILITY RAIN JACKET	60	62936	W F2F COTTON HOODIE	109
11650	ODIN PRIMALOFT HIKER HT	195	51852	VANERN MIDLAYER	50	62935	W F2F COTTON SWEATER	109
62833	ODIN STRETCH HOODED INSULATOR JACKET	29	62788	VANIR BRONO PANT	31	51863	W FEATHER PILE JACKET	123
62914	ODIN STRETCH HOODED LIGHT INSULATOR JACKET	29	11630	VARANGER PRIMALOFT	195	67465	W FREERIDE MIX GLOVE	180
62940	ODIN STRETCH LIGHT INSULATOR VES	29	51851	VARDE 1/2 ZIP FLEECE	52	11445	W FREMONT	205
65739	OMEGA JACKET	17	51850	VARDE FLEECE JACKET	51	11633	W GAMVIK	202
67184	OSLO BACKPACK	186	51891	VARDE HOODED FLEECE JACKET	51	11592	W GARIBALDI VL	202
62921	OSLO LS SHIRT	38	63001	VEIR TUR PANT	30	67455	W GLACIER GLOVE	180
51867	OSLO REVERSIBLE PILE JACKET	52	62947	VERGLAS 1/2 ZIP	33	63031	W GREFSEN 2L SHELL JACKET	105
67147	OUTLINE BEANIE	170	62831	VERGLAS 3L SHELL JACKET	30	48326	W HH LIFA CREW	118
67148	OUTLINE HEADBAND	170	62999	VERGLAS 3L SHELL PANT	30	48331	W HH LIFA PANT	118
67149	OUTLINE REVERSIBLE BEANIE	170	63006	VERGLAS DOWN INSULATOR JACKET	32	34003	W HH LOGO CREW SWEAT	144
62987	PARAMOUNT HOODED SOFTSHELL JACKET	33	63008	VERGLAS DOWN INSULATOR VEST	32	33978	W HH LOGO HOODIE	144
62915	PARAMOUNT SOFTSHELL JACKET	33	62949	VERGLAS GO T-SHIRT	33	34112	W HH LOGO T-SHIRT	144
62916	PARAMOUNT SOFTSHELL VEST	34	63007	VERGLAS HOODED DOWN HYBRID INSULATOR JACKET	32	51812	W HH MERINO HOODED JACKET	123
34157	PIER 3.0 BIB	69	63005	VERGLAS HOODED DOWN INSULATOR JACKET	31	48497	W HH MERINO MID 1/2 ZIP	116
34156	PIER 3.0 JACKET	68	63002	VERGLAS ICEFALL DOWN JACKET	31	48473	W HH MERINO MID GRAPHIC 1/2 ZIP	116
51885	POWER AIR HEAT GRID JACKET	50	62946	VERGLAS LIGHT HOODIE	32	49307	W HH MERINO MID GRAPHIC LS	116
51887	POWER STRETCH PHANTOM 1/2 ZIP 3.0	50	63000	VERGLAS TUR PANT	30	49308	W HH MERINO MID GRAPHIC PANT	117
51886	POWER STRETCH PRO GLACIER HOODED JACKET	50	11647	VERNON LEATHER	196	48496	W HH MERINO MID LS	116
11611	RICHMOND	197	67436	VISBY BACKPACK	187	48499	W HH MERINO MID PANT	117
65610	RIDGE SHELL 2.0 JACKET	21	67806	VOR GLOVE	178	48374	W HH TECH CREW LS	119
65616	RIDGE SHELL PANT	22	49392	W LIFA ACTIVE 1/2 ZIP	117	48373	W HH TECH T-SHIRT	119
67150	RIDGELINE BEANIE	171	49393	W LIFA ACTIVE CREW	117	49372	W HOD LIFA MERINO LIGHTWEIGHT 1/2 ZIP	86
50982	RIFTLINE POLO	74	49401	W LIFA ACTIVE GRAPHIC CREW	118	63038	W HOLMEN 5 POCKET PANT	107
53508	RIGGING COAT	59	49394	W LIFA ACTIVE PANT	118	63032	W HOVIN INSULATED JACKET	104
65741	RIVA LIFALOFT JACKET	18	49373	W LIFA MERINO HEAVYWEIGHT 1/2 ZIP	112	34081	W HP OCEAN SWT JACKET	142
65689	RIVARIDGE PUFFY JACKET	17	49374	W LIFA MERINO HEAVYWEIGHT CREW	112	34069	W HP RACING JACKET	138
67418	ROAM GLOVES	178	49375	W LIFA MERINO HEAVYWEIGHT PANT	112	34070	W HP RACING MIDLAYER JACKET	139
67418	ROAM GLOVES	40	49383	W LIFA MERINO LIGHTWEIGHT 1/2 ZIP	115	63041	W HYGGEN LONGSLEEVE	109
67415	ROAM TRAPPER HAT	40	49384	W LIFA MERINO LIGHTWEIGHT CREW	115	62932	W HYTE DRESS	108
65714	RUSSI SOFTSHELL STRETCH JACKET	14	49385	W LIFA MERINO LIGHTWEIGHT GRAPHIC CREW	115	65690	W IMPERIAL PUFFY JACKET	88
65718	RUSSI SOFTSHELL STRETCH PANT	16	49382	W LIFA MERINO LIGHTWEIGHT HOODIE	114	53313	W JPN CORD JACKET	128
63016	RYES SNAP FLEECE SHIRT JACKET	38	49386	W LIFA MERINO LIGHTWEIGHT PANT	115	53549	W JPN PUFFY JACKET	126
67771	SAILING GLOVE LONG	184	49377	W LIFA MERINO MIDWEIGHT 1/2 ZIP	113	53546	W JPN QUILTED COAT	126
67772	SAILING GLOVE SHORT	184	49381	W LIFA MERINO MIDWEIGHT 3/4 PANT	114	53402	W JPN RAINCOAT	126
34173	SALTRO JACKET	69	49378	W LIFA MERINO MIDWEIGHT CREW	113	53547	W JPN REVERSIBLE COAT	127
67453	SEA GEAR BEANIE	172	49379	W LIFA MERINO MIDWEIGHT GRAPHIC CREW	114	53404	W JPN SPRING JACKET	128
62047	SEVEN J JACKET	62	49376	W LIFA MERINO MIDWEIGHT HOODIE	112	67458	W JUNIPER GLOVE	180
62372	SEVEN J PANT	62	49380	W LIFA MERINO MIDWEIGHT PANT	114	11623	W KAMBO 1877 BOOT	206
11620	SHADOWLAND	197	54429	W ADEN DOWN PARKA	130	53252	W KIRK WALL II RAINCOAT	135
11625	SHERWOOD INSULATED	195	62649	W ADEN INSULATED COAT	132	63036	W KULPEN PRINTED FLEECE	106
34125	SKAGEN LONG SLEEVE	74	62650	W ADEN JACKET	133	67463	W LEATHER MIX GLOVE	179
33997	SKAGEN MERINO SWEATER	73	62648	W ADEN LONG COAT	133	65683	W LEGENDARY INSULATED PANT	90
33908	SKAGEN OFFSHORE BIB	68	62651	W ADEN PANT	133	53215	W LEONIE DOWN JACKET	130
33907	SKAGEN OFFSHORE JACKET	68	33884	W AEGIR RACE JACKET	136	65703	W LIFALOFT FULL ZIP INSULATOR	94
34046	SKAGEN QUICKDRY RUGGER	73	33885	W AEGIR RACE SALOPETTE	136	65626	W LIFALOFT HOODED INSULATOR JACKET	93
62898	SKAR PANT	37	67464	W ALL MOUNTAIN GLOVE	179	65687	W LIFALOFT HOODED STRETCH INSULATOR JACKET	93
62856	SKOG GRAPHIC T-SHIRT	40	65676	W ALPHELIA LIFALOFT JACKET	88	65627	W LIFALOFT HYBRID INSULATOR JACKET	93
65574	SOGN BIB SHELL PANT	23	65630	W ALPHELIA PANT	89	65624	W LIFALOFT INSULATOR COAT	92
65673	SOGN CARGO PANT	23	11636	W ANNABELLE BOOT	203	65625	W LIFALOFT INSULATOR JACKET	93
65748	SOGN SHELL 2.0 JACKET	21	34079	W ARCTIC OCEAN CHUNKY KNIT	136	65629	W LIFALOFT PROPYLE VEST	94
67421	SPORT DUFFEL 50L	184	34082	W ARCTIC OCEAN WINDPROOF PILE	136	65757	W LIFALOFT SKIRT	94
67431	SPORT DUFFEL 70L	184	53503	W ARYA PARKA	129	65755	W LIFALOFT SUIT	85
67432	SPORT DUFFEL 90L	185	53517	W ASPIRE RAIN COAT	131	65756	W LIFALOFT TOASTY COAT	92
62368	SQUAMISH CIS JACKET	62	54283	W ASTRA JACKET	122	63044	W LILLO LONG ZIP	107
65738	STIELHANG JACKET	16	65634	W AURORA SHELL 2.0 JACKET	91	63037	W LILLO SWEATER	106
11510	STOCKHOLM 2	197	65638	W AURORA SHELL 2.0 PANT	91	67156	W LIMELIGHT BEANIE	175
67187	STOCKHOLM BACKPACK	187	65732	W AVANTI JACKET	87	63033	W LINDE INSULATED ANORAK	105
65671	STRAIGHTLINE JACKET	22	65737	W AVANTI STRETCH PANT	89	63034	W LINDE INSULATED VEST	105
53150	SVALBARD PARKA	58	65723	W BANCO PUFFY JACKET	84	11517	W LOKE BOWRON LEATHER	204
65599	SWIFT 4.0 JACKET	18	65729	W BANCO PUFFY PANT	87	62282	W LOKE JACKET	104
67324	SWIFT HT GLOVE	177	65736	W BELLISSIMO 2 PANT	90	62266	W LOKE PANTS	104
67335	SWIFT HT MITTENS	178	65734	W BLUEBIRD JACKET	89	62395	W LONG BELFAST WINTER JACKET	132
11618	TAMARACK	198	54430	W BLUME PUFFY PARKA	130	51859	W LYRA 1/2 ZIP	123
34144	TEAM CREW MIDLAYER JACKET	71	67266	W CALGARY CHUNKY BEANIE	175	51860	W LYRA JACKET	122
62943	TINDEN LIGHT PANT	31	62930	W CLASSIC CHECK LS SHIRT	108	65678	W MAJESTIC WARM JACKET	88
67404	TRAVERSE BEANIE	171	33899	W CREW HOODED JACKET	139	63040	W MALMOYA HOODED DRESS	108

63035	W MALMOYA ZIP PILE	105	65733	W VALDISERE PUFFY JACKET	89
11255	W MARION	205	62813	W VANIR HYBRID PANT	100
51832	W MARKA WOOL SWEATER	123	11631	W VARANGER PRIMALOFT	203
53303	W MAYEN PARKA	129	51861	W VARDE FLEECE 1/2 ZIP	121
11663	W MIDSUND 3	206	51862	W VARDE FLEECE JACKET	121
53316	W MOSS INS COAT	134	51892	W VARDE HOODED FLEECE JACKET	120
53253	W MOSS JACKET	135	11664	W VEIERLAND 3	207
53254	W MOSS PANT	135	63023	W VEIR TUR PANT	100
53251	W MOSS RAIN COAT	134	62965	W VERGLAS 1/2 ZIP	102
65677	W MOTIONISTA LIFALOFT JACKET	88	62835	W VERGLAS 3L SHELL JACKET	99
63039	W MYRA LEGGINGS	107	63021	W VERGLAS 3L SHELL PANT	99
53035	W NAIAD FLEECE JACKET	142	62966	W VERGLAS 7/8 TIGHTS	103
62980	W NORD GRAPHIC FZ HOODIE	110	63028	W VERGLAS DOWN INSULATOR JACKET	101
62983	W NORD GRAPHIC LONGSLEEVE T-SHIRT	110	63030	W VERGLAS DOWN INSULATOR VEST	102
62981	W NORD GRAPHIC PULL OVER HOODIE	110	63026	W VERGLAS HOODED DOWN HYBRID INSULATOR JACKET	101
11661	W NORDVIK 2	207	63027	W VERGLAS HOODED DOWN INSULATOR JACKET	101
63043	W ODDEN STRIPE KNIT SWEATER	106	63024	W VERGLAS ICEFALL DOWN JACKET	101
62956	W ODIN 9 WORLDS 2.0 JACKET	98	62964	W VERGLAS LIGHT HOODIE	102
63020	W ODIN LIFALOFT DOWN HYBRID	97	63029	W VERGLAS LONG DOWN INSULATOR JACKET	102
62957	W ODIN LIGHT 3D SHELL JACKET	98	62967	W VERGLAS PACE T-SHIRT	103
62909	W ODIN MOUNTAIN 3L SHELL BIB PANT	96	63022	W VERGLAS TUR PANT	100
62908	W ODIN MOUNTAIN 3L SHELL JACKET	96	53247	W WELSEY II TRENCH	132
62910	W ODIN MOUNTAIN SOFTSHELL JACKET	96	53314	W WELSEY II TRENCH INSULATED	132
62911	W ODIN MOUNTAIN SOFTSHELL PANT	96	65684	W WHITEWALL LIFALOFT JACKET	91
62764	W ODIN MUNINN PANT	99	62928	W WOOL KNIT SWEATER	106
11651	W ODIN PRIMALOFT HIKER HT	204	62929	W WOOL TRAVEL PANT	107
62832	W ODIN STRETCH HOODED INSULATOR JACKET	98	62918	WOOL KNIT SWEATER	36
62924	W ODIN STRETCH HOODED LIGHT INSULATOR JACKET	98	62937	WOOL LS SHIRT	38
62958	W ODIN STRETCH LIGHT INSULATOR VEST	99	62919	WOOL TRAVEL PANT	37
62931	W OSLO LS SHIRT	108			
62988	W PARAMOUNT HOODED SOFTSHELL JACKET	103			
62925	W PARAMOUNT SOFTSHELL JACKET	103			
62926	W PARAMOUNT SOFTSHELL VEST	104			
33961	W PIER 3.0 BIB	138			
34177	W PIER 3.0 JACKET	138			
65731	W PINNACLE JACKET	87			
65701	W POWCHASER LIFALOFT JACKET	91			
67152	W POWDER BEANIE	175			
65753	W POWDERQUEEN 3.0 JACKET	90			
65643	W POWDERQUEEN BIB PANT	92			
51888	W POWER AIR HEAT GRID JACKET	120			
51890	W POWER STRETCH PHANTOM 1/2 ZIP 3.0	120			
51889	W POWER STRETCH PRO GLACIER HOODED JACKET	120			
51798	W PRECIOUS FLEECE JACKET	122			
51848	W PRECIOUS PULL OVER FLEECE	122			
62864	W RASK TIGHTS	100			
53500	W REGINA PARKA	129			
11612	W RICHMOND	206			
53512	W RIGGING COAT	131			
65725	W ROSI BIB SOFTSHELL PANT	86			
65722	W ROSI INSULATED SOFTSHELL JACKET	84			
33998	W SALTRO JACKET	138			
65721	W SAPPORO FRINGE STRETCH JACKET	84			
65726	W SAPPORO STRETCH HIGHWAIST PANT	86			
53191	W SENSE DOWN JACKET	129			
11527	W SERAPHINA DEMI	203			
62066	W SEVEN J JACKET	134			
62381	W SEVEN J PANT	134			
11626	W SHERWOOD INSULATED	204			
34140	W SIREN HOODIE	142			
34129	W SKAGEN KNIT	143			
34139	W SKAGEN LONG SLEEVE	142			
33921	W SKAGEN OFFSHORE BIB	137			
33920	W SKAGEN OFFSHORE JACKET	137			
62877	W SKOG GRAPHIC T-SHIRT	109			
65730	W SNOW BOOT GAITORS	87			
67407	W SNOWFALL BEANIE	174			
11652	W SORRENTO	202			
53206	W SQUAMISH 2.0 CIS JACKET	133			
11511	W STOCKHOLM 2	205			
53218	W SVALBARD 2 PARKA	128			
65754	W SWITCH CARGO INSULATED PANT	92			
34145	W TEAM CREW MIDLAYER JACKET	140			
33945	W THALIA LS-SHIRT	143			
53057	W THALIA PANT	143			
65724	W TRICOLORE INSULATED JACKET	84			
65728	W TRICOLORE KNITTED SWEATER	86			
65727	W TRICOLORE QUILTED INSULATOR JACKET	85			
11627	W TRINITY BOOT	205			
11537	W TUNDRA CWB 2	203			
53301	W TUNDRA DOWN COAT	128			
53507	W URBAN LINER	131			
53506	W URBAN LINER COAT	130			

INDEX NUMERIC

11157	GERTON	196	34069	W HP RACING JACKET	138	48326	W HH LIFA CREW	118
11255	W MARION	205	34070	W HP RACING MIDLAYER JACKET	139	48331	W HH LIFA PANT	118
11422	GARIBALDI V3	194	34071	W CREW INSULATOR JACKET	140	48355	HH MERINO MID LS	46
11445	W FREMONT	205	34072	W CREW INSULATOR VEST	141	48356	HH MERINO MID 1/2 ZIP	45
11510	STOCKHOLM 2	197	34074	ARCTIC OCEAN HYBRID INSULATOR	67	48363	HH TECH T-SHIRT	48
11511	W STOCKHOLM 2	205	34079	W ARCTIC OCEAN CHUNKY KNIT	136	48364	HH TECH CREW	48
11516	LOKE BOWRON LEATHER	196	34081	W HP OCEAN SWT JACKET	142	48365	HH TECH 1/2 ZIP	48
11517	W LOKE BOWRON LEATHER	204	34082	W ARCTIC OCEAN WINDPROOF PILE	136	48373	W HH TECH T-SHIRT	119
11527	W SERAPHINA DEMI	203	34093	ARCTIC OCEAN PARKA	66	48374	W HH TECH CREW LS	119
11536	TUNDRA CWB 2	195	34095	ARCTIC SHORE SWEATER	68	48471	HH MERINO MID PANT	46
11537	W TUNDRA CWB 2	203	34112	W HH LOGO T-SHIRT	144	48473	W HH MERINO MID GRAPHIC 1/2 ZIP	116
11592	W GARIBALDI VL	202	34113	AEGIR OCEAN JACKET	64	48496	W HH MERINO MID LS	116
11611	RICHMOND	197	34123	HP SHORE LS POLO	73	48497	W HH MERINO MID 1/2 ZIP	116
11612	W RICHMOND	206	34124	FJORD LONG SLEEVE	74	48499	W HH MERINO MID PANT	117
11618	TAMARACK	198	34125	SKAGEN LONG SLEEVE	74	48610	K HH LIFA MERINO SET	165
11620	SHADOWLAND	197	34129	W SKAGEN KNIT	143	48647	JR HH LIFA ACTIVE SET	158
11622	KAMBO 1877 BOOT	198	34139	W SKAGEN LONG SLEEVE	142	48800	HH LIFA STRIPE CREW	47
11623	W KAMBO 1877 BOOT	206	34140	W SIREN HOODIE	142	49307	W HH MERINO MID GRAPHIC LS	116
11624	MONTESANO BOOT	197	34142	CREW SWEATSHIRT	72	49308	W HH MERINO MID GRAPHIC PANT	117
11625	SHERWOOD INSULATED	195	34143	W CREW SWEATSHIRT	141	49311	JR HH MERINO MID SET	157
11626	W SHERWOOD INSULATED	204	34144	TEAM CREW MIDLAYER JACKET	71	49312	K HH MERINO MID SET	165
11627	W TRINITY BOOT	205	34145	W TEAM CREW MIDLAYER JACKET	140	49359	LIFA MERINO HEAVYWEIGHT 1/2 ZIP	42
11630	VARANGER PRIMALOFT	195	34156	PIER 3.0 JACKET	68	49360	LIFA MERINO HEAVYWEIGHT CREW	42
11631	W VARANGER PRIMALOFT	203	34157	PIER 3.0 BIB	69	49361	LIFA MERINO HEAVYWEIGHT PANT	42
11632	GAMVIK	194	34163	HH LOGO FULL ZIP HOODIE	75	49362	LIFA MERINO MIDWEIGHT HOODIE	43
11633	W GAMVIK	202	34173	SALTRO JACKET	69	49363	LIFA MERINO MIDWEIGHT 1/2 ZIP	42
11636	W ANNABELLE BOOT	203	34177	W PIER 3.0 JACKET	138	49364	LIFA MERINO MIDWEIGHT CREW	44
11647	VERNON LEATHER	196	38791	LOGO CAP	183	49366	LIFA MERINO MIDWEIGHT PANT	44
11649	GARIBALDI PRIMALOFT BOOT	194	40330	JR DUBLINER PANT	154	49367	LIFA MERINO MIDWEIGHT 3/4 PANT	44
11650	ODIN PRIMALOFT HIKER HT	195	40342	K RIDER 2 INS BIB	162	49368	LIFA MERINO LIGHTWEIGHT HOODIE	44
11651	W ODIN PRIMALOFT HIKER HT	204	40360	K BERGEN PU RAINSET	163	49369	LIFA MERINO LIGHTWEIGHT 1/2 ZIP	45
11652	W SORRENTO	202	40362	K DAYBREAKER 2.0 JACKET	164	49370	LIFA MERINO LIGHTWEIGHT CREW	45
11660	NORDVIK 2	198	40366	K VERTICAL INS BIB PANT	161	49371	LIFA MERINO LIGHTWEIGHT PANT	45
11661	W NORDVIK 2	207	40374	K LEGEND INS JACKET	161	49372	W HOD LIFA MERINO LIGHTWEIGHT 1/2 ZIP	86
11662	MIDSUND 3	199	40379	K SHELTER JACKET	163	49373	W LIFA MERINO HEAVYWEIGHT 1/2 ZIP	112
11663	W MIDSUND 3	206	40384	K MOSS PU RAINSET	163	49374	W LIFA MERINO HEAVYWEIGHT CREW	112
11664	W VEIERLAND 3	207	40393	K RIDER 2 INS JACKET	160	49375	W LIFA MERINO HEAVYWEIGHT PANT	112
26665	JR HH LIFA SET	158	40470	K TINDEN SKISUIT	160	49376	W LIFA MERINO MIDWEIGHT HOODIE	112
30253	CREW MIDLAYER JACKET	70	40473	K TINDEN INS JACKET	160	49377	W LIFA MERINO MIDWEIGHT 1/2 ZIP	113
30263	CREW JACKET	70	40477	K OSLO PARKA	162	49378	W LIFA MERINO MIDWEIGHT CREW	113
30270	CREW VEST	71	40478	K VIKA PUFFY JACKET	162	49379	W LIFA MERINO MIDWEIGHT GRAPHIC CREW	114
30290	W CREW VEST	140	40479	K STORM REVERSIBLE INSULATOR	164	49380	W LIFA MERINO MIDWEIGHT PANT	114
30297	W CREW JACKET	139	40481	K CHAMP REVERSIBLE JACKET	164	49381	W LIFA MERINO MIDWEIGHT 3/4 PANT	114
30317	W CREW MIDLAYER JACKET	139	40482	K CHAMP 1/2 ZIP MIDLAYER	164	49382	W LIFA MERINO LIGHTWEIGHT HOODIE	114
31706	ÆGIR OCEAN DRY SUIT	66	40483	K DAYBREAKER HOODIE	165	49383	W LIFA MERINO LIGHTWEIGHT 1/2 ZIP	115
33869	ÆGIR RACE JACKET	64	40493	K HH MERINO MID TOP	166	49384	W LIFA MERINO LIGHTWEIGHT CREW	115
33871	AEGIR RACE SALOPETTE	64	40494	K HH MERINO MID BOTTOMS	166	49385	W LIFA MERINO LIGHTWEIGHT GRAPHIC CREW	115
33874	CREW HOODED MIDLAYER JACKET	70	41026	K SHELTER PANT	163	49386	W LIFA MERINO LIGHTWEIGHT PANT	115
33875	CREW HOODED JACKET	70	41084	K DAYBREAKER FLEECE PANT	165	49388	LIFA ACTIVE 1/2 ZIP	46
33884	W ÆGIR RACE JACKET	136	41606	JR LEGENDARY PANT	151	49389	LIFA ACTIVE CREW	47
33885	W ÆGIR RACE SALOPETTE	136	41612	JR ISFJORD DOWN MIX JACKET	152	49390	LIFA ACTIVE PANT	47
33891	W CREW HOODED MIDLAYER JACKET	140	41616	JR FELIX PARKA	153	49392	W LIFA ACTIVE 1/2 ZIP	117
33899	W CREW HOODED JACKET	139	41661	JR DAYBREAKER 2.0 JACKET	155	49393	W LIFA ACTIVE CREW	117
33907	SKAGEN OFFSHORE JACKET	68	41674	JR MOSS JACKET	154	49394	W LIFA ACTIVE PANT	118
33908	SKAGEN OFFSHORE BIB	68	41675	JR MOSS PANT	155	49401	W LIFA ACTIVE GRAPHIC CREW	118
33920	W SKAGEN OFFSHORE JACKET	137	41681	JR DIAMOND JACKET	148	49402	HH MERINO MID GRAPHIC CREW	46
33921	W SKAGEN OFFSHORE BIB	137	41683	JR LIFALOFT INS JACKET	151	49403	JR LIFA MERINO MIDWEIGHT SET	157
33945	W THALIA LS-SHIRT	143	41685	JR MAYA PARKA	154	50844	DAYBREAKER 1/2 ZIP FLEECE	54
33961	W PIER 3.0 BIB	138	41688	JR DAYBREAKER HOODIE	156	50845	W DAYBREAKER 1/2 ZIP FLEECE	124
33976	ÆGIR RACE SMOCK LIGHT	64	41689	JR CYCLONE JACKET	148	50982	RIFTLINE POLO	74
33977	HH LOGO HOODIE	75	41720	JR FLY HIGH INS SKI SUIT	148	51598	DAYBREAKER FLEECE JACKET	53
33978	W HH LOGO HOODIE	144	41721	JR WHITEOUT JACKET	149	51599	W DAYBREAKER FLEECE JACKET	124
33979	HH LOGO T-SHIRT	76	41722	JR SAPPHIRE JACKET	149	51742	DAYBREAKER FLEECE PANT	54
33984	W CREW TECH POLO	141	41723	JR TORNADO JACKET	150	51743	W DAYBREAKER FLEECE PANT	124
33996	HH QD CARGO PANT	75	41726	JR BLAZE JACKET	150	51798	W PRECIOUS FLEECE JACKET	122
33997	SKAGEN MERINO SWEATER	73	41727	JR DIVINE JACKET	150	51802	MARKA WOOL SWEATER	53
33998	W SALTRO JACKET	138	41729	JR NO LIMITS 2.0 PANT	151	51806	JUELL PILE JACKET	52
34000	HH LOGO CREW SWEAT	76	41730	JR URBAN PUFFY PARKA	152	51811	HH MERINO HOODED JACKET	53
34003	W HH LOGO CREW SWEAT	144	41731	JR LUCA PUFFY PARKA	153	51812	W HH MERINO HOODED JACKET	123
34004	CREW POLO	74	41732	JR RADICAL PUFFY JACKET	153	51831	DAYBREAKER FLEECE VEST	54
34005	AEGIR OCEAN DRY TOP	65	41733	JR INFINITY INSULATOR JACKET	152	51832	W MARKA WOOL SWEATER	123
34006	AEGIR OCEAN SMOCK	65	41735	JR URBAN RAIN JACKET	154	51848	W PRECIOUS PULL OVER FLEECE	122
34007	AEGIR OCEAN TROUSERS	66	41736	JR CHAMP REVERSIBLE JACKET	155	51849	FEATHER PILE JACKET	52
34040	HP RACING JACKET	69	41737	JR CHAMP 1/2 ZIP MIDLAYER	155	51850	VARDE FLEECE JACKET	51
34041	HP RACING MIDLAYER JACKET	69	41740	JR SUMMIT BIB PANT	151	51851	VARDE 1/2 ZIP FLEECE	52
34043	HP FLEECE JACKET	72	41741	JR GRAPHIC HOODIE	156	51852	VANERN MIDLAYER	50
34044	HP OCEAN FZ HOODIE	72	41742	JR GRAPHIC LS T-SHIRT	156	51859	W LYRA 1/2 ZIP	123
34046	SKAGEN QUICKDRY RUGGER	73	41743	JR GRAPHIC T-SHIRT	156	51860	W LYRA JACKET	122
34059	ARCTIC OCEAN PUFFY JACKET	67	41747	JR HH MERINO MID TOP	157	51861	W VARDE FLEECE 1/2 ZIP	121
34062	ARCTIC OCEAN WINDPROOF SWEATER	67	41748	JR HH MERINO MID BOTTOMS	157	51862	W VARDE FLEECE JACKET	121
34063	ARCTIC OCEAN WINDPROOF PILE	67	48305	HH LIFA PANT	47	51863	W FEATHER PILE JACKET	123

51867	OSLO REVERSIBLE PILE JACKET	52	62395	W LONG BELFAST WINTER JACKET	132	63009	GREFSEN 2L SHELL JACKET	35
51885	POWER AIR HEAT GRID JACKET	50	62643	DUBLINER JACKET	61	63010	HOVIN INSULATED JACKET	35
51886	POWER STRETCH PRO GLACIER HOODED JACKET..	50	62648	W ADEN LONG COAT	133	63011	MEYER INSULATED JACKET	35
51887	POWER STRETCH PHANTOM 1/2 ZIP 3.0	50	62649	W ADEN INSULATED COAT	132	63012	MEYER INSULATED VEST	35
51888	W POWER AIR HEAT GRID JACKET	120	62650	W ADEN JACKET	133	63013	KOLSAAS FLEECE JACKET	36
51889	W POWER STRETCH PRO GLACIER HOODED JACKET	120	62651	W ADEN PANT	133	63014	KULPEN PRINTED FLEECE	36
51890	W POWER STRETCH PHANTOM 1/2 ZIP 3.0	120	62652	DUBLINER PANT	61	63015	LILLO SWEATER	37
51891	VARDE HOODED FLEECE JACKET	51	62764	W ODIN MUNINN PANT	99	63016	RYES SNAP FLEECE SHIRT JACKET	38
51892	W VARDE HOODED FLEECE JACKET	120	62788	VANIR BRONO PANT	31	63017	HYGGEN LIGHT HOODIE	39
51893	DAYBREAKER LOGO HOODIE	53	62813	W VANIR HYBRID PANT	100	63019	HYGGEN LS HENLEY	40
51894	W DAYBREAKER LOGO HOODIE	124	62831	VERGLAS 3L SHELL JACKET	30	63020	W ODIN LIFALOFT DOWN HYBRID	97
53035	W NAIAD FLEECE JACKET	142	62832	W ODIN STRETCH HOODED INSULATOR JACKET	98	63021	W VERGLAS 3L SHELL PANT	99
53055	W CREW PIQUE 2 POLO	141	62833	ODIN STRETCH HOODED INSULATOR JACKET	29	63022	W VERGLAS TUR PANT	100
53057	W THALIA PANT	143	62835	W VERGLAS 3L SHELL JACKET	99	63023	W VEIR TUR PANT	100
53117	DUBLINER INSULATED JACKET	61	62856	SKOG GRAPHIC T-SHIRT	40	63024	W VERGLAS ICEFALL DOWN JACKET	101
53145	CHILL PARKA	57	62864	W RASK TIGHTS	100	63026	W VERGLAS HOODED DOWN HYBRID INSULATOR JACKET	101
53150	SVALBARD PARKA	58	62877	W SKOG GRAPHIC T-SHIRT	109	63027	W VERGLAS HOODED DOWN INSULATOR JACKET..	101
53167	BARENTS PARKA	58	62897	HOLMEN 5 POCKET PANT	37	63028	W VERGLAS DOWN INSULATOR JACKET	101
53181	URBAN LONG JACKET	58	62898	SKAR PANT	37	63029	W VERGLAS LONG DOWN INSULATOR JACKET	102
53191	W SENSE DOWN JACKET	129	62901	ODIN MOUNTAIN 3L SHELL JACKET	26	63030	W VERGLAS DOWN INSULATOR VEST	102
53206	W SQUAMISH 2.0 CIS JACKET	133	62902	ODIN MOUNTAIN 3L SHELL BIB PANT	26	63031	W GREFSEN 2L SHELL JACKET	105
53215	W LEONIE DOWN JACKET	130	62903	ODIN MOUNTAIN SOFTSHELL JACKET	27	63032	W HOVIN INSULATED JACKET	104
53218	W SVALBARD 2 PARKA	128	62904	ODIN MOUNTAIN SOFTSHELL PANT	27	63033	W LINDE INSULATED ANORAK	105
53247	W WELSEY II TRENCH	132	62908	W ODIN MOUNTAIN 3L SHELL JACKET	96	63034	W LINDE INSULATED VEST	105
53251	W MOSS RAIN COAT	134	62909	W ODIN MOUNTAIN 3L SHELL BIB PANT	96	63035	W MALMOYA ZIP PILE	105
53252	W KIRK WALL II RAINCOAT	135	62910	W ODIN MOUNTAIN SOFTSHELL JACKET	96	63036	W KULPEN PRINTED FLEECE	106
53253	W MOSS JACKET	135	62911	W ODIN MOUNTAIN SOFTSHELL PANT	96	63037	W LILLO SWEATER	106
53254	W MOSS PANT	135	62914	ODIN STRETCH HOODED LIGHT INSULATOR JACKET	29	63038	W HOLMEN 5 POCKET PANT	107
53265	MOSS RAIN COAT	63	62915	PARAMOUNT SOFTSHELL JACKET	33	63039	W MYRA LEGGINGS	107
53267	MOSS JACKET	63	62916	PARAMOUNT SOFTSHELL VEST	34	63040	W MALMOYA HOODED DRESS	108
53268	MOSS PANT	63	62918	WOOL KNIT SWEATER	36	63041	W HYGGEN LONGSLEEVE	109
53301	W TUNDRA DOWN COAT	128	62919	WOOL TRAVEL PANT	37	63042	ODDEN STRIPE KNIT SWEATER	36
53303	W MAYEN PARKA	129	62920	LIFALOFT™ INSULATED FLANNEL SHIRT	38	63043	W ODDEN STRIPE KNIT SWEATER	106
53313	W JPN CORD JACKET	128	62921	OSLO LS SHIRT	38	63044	W LILLO LONG ZIP	107
53314	W WELSEY II TRENCH INSULATED	132	62923	CLASSIC CHECK LS SHIRT	39	63046	ODIN INFINITY SHELL JACKET	26
53316	W MOSS INS COAT	134	62924	W ODIN STRETCH HOODED LIGHT INSULATOR JACKET	98	65551	ALPHA 3.0 JACKET	17
53324	HUDSON PARKA	57	62925	W PARAMOUNT SOFTSHELL JACKET	103	65574	SOGN BIB SHELL PANT	23
53340	MOSS INSULATED RAIN COAT	62	62926	W PARAMOUNT SOFTSHELL VEST	104	65598	JUNIPER 3.0 JACKET	18
53402	W JPN RAINCOAT	126	62928	W WOOL KNIT SWEATER	106	65599	SWIFT 4.0 JACKET	18
53404	W JPN SPRING JACKET	128	62929	W WOOL TRAVEL PANT	107	65603	LIFALOFT INSULATOR JACKET	24
53408	JPN RAIN JACKET	56	62930	W CLASSIC CHECK LS SHIRT	108	65604	LIFALOFT HOODED INSULATOR JACKET	24
53415	UTILITY RAIN JACKET	60	62931	W OSLO LS SHIRT	108	65605	LIFA LOFT HYBRID INSULATOR JACKET	24
53416	URBAN RAIN JACKET	60	62932	W HYTTE DRESS	108	65606	LIFALOFT INSULATOR VEST	25
53491	TROMSOE PARKA	58	62933	F2F COTTON SWEATER	39	65610	RIDGE SHELL 2.0 JACKET	21
53495	URBAN LINER	59	62934	F2F COTTON HOODIE	39	65616	RIDGE SHELL PANT	22
53496	URBAN HOODED LINER	59	62935	W F2F COTTON SWEATER	109	65624	W LIFALOFT INSULATOR COAT	92
53500	W REGINA PARKA	129	62936	W F2F COTTON HOODIE	109	65625	W LIFALOFT INSULATOR JACKET	93
53503	W ARYA PARKA	129	62937	WOOL LS SHIRT	38	65626	W LIFALOFT HOODED INSULATOR JACKET	93
53506	W URBAN LINER COAT	130	62938	ODIN 9 WORLDS 2.0 JACKET	28	65627	W LIFALOFT HYBRID INSULATOR JACKET	93
53507	W URBAN LINER	131	62939	ODIN LIGHT 3D SHELL JACKET	28	65629	W LIFALOFT PROPILE VEST	94
53508	RIGGING COAT	59	62940	ODIN STRETCH LIGHT INSULATOR VEST	29	65630	W ALPHELIA PANT	89
53509	UTILITY INSULATED PARKA	60	62943	TINDEN LIGHT PANT	31	65634	W AURORA SHELL 2.0 JACKET	91
53510	DUBLINER INSULATED LONG JACKET	61	62946	VERGLAS LIGHT HOODIE	32	65638	W AURORA SHELL 2.0 PANT	91
53511	UTILITY INSULATED RAIN JACKET	60	62947	VERGLAS 1/2 ZIP	33	65643	W POWDERQUEEN BIB PANT	92
53512	W RIGGING COAT	131	62949	VERGLAS 60 T-SHIRT	33	65667	ALPHA LIFALOFT JACKET	17
53517	W ASPIRE RAIN COAT	131	62952	ESSENTIAL CANVAS PANT	34	65670	FIRSTTRACK LIFALOFT™ JACKET	21
53542	JPN 3IN1 PARKA	55	62956	W ODIN 9 WORLDS 2.0 JACKET	98	65671	STRAIGHTLINE JACKET	22
53544	JPN CORD JACKET	55	62957	W ODIN LIGHT 3D SHELL JACKET	98	65673	SOGN CARGO PANT	23
53545	JPN QUILTED 1/2 ZIP HOODIE	56	62958	W ODIN STRETCH LIGHT INSULATOR VEST	99	65674	LIFALOFT HOODED STRETCH INSULATOR	24
53546	W JPN QUILTED COAT	126	62964	W VERGLAS LIGHT HOODIE	102	65676	W ALPHELIA LIFALOFT JACKET	88
53547	W JPN REVERSIBLE COAT	127	62965	W VERGLAS 1/2 ZIP	102	65677	W MOTIONISTA LIFALOFT JACKET	88
53549	W JPN PUFFY JACKET	126	62966	W VERGLAS 7/8 TIGHTS	103	65678	W MAJESTIC WARM JACKET	88
53566	JPN PUFFY JACKET	55	62967	W VERGLAS PACE T-SHIRT	103	65683	W LEGENDARY INSULATED PANT	90
53584	ACTIVE HOODED MIDLAYER JACKET	72	62975	NORD GRAPHIC PULL OVER HOODIE	41	65684	W WHITEWALL LIFALOFT JACKET	91
54154	HH QD CARGO SHORTS 11	75	62976	NORD GRAPHIC CREW SWEATSHIRT	41	65687	W LIFALOFT HOODED STRETCH INSULATOR JACKET	93
54213	HP 1/2 ZIP PULLOVER	73	62977	NORD GRAPHIC LONGSLEEVE T-SHIRT	41	65689	RIVARIDGE PUFFY JACKET	17
54283	W ASTRA JACKET	122	62978	NORD GRAPHIC T-SHIRT	41	65690	W IMPERIAL PUFFY JACKET	88
54344	CREW INSULATOR JACKET	71	62980	W NORD GRAPHIC FZ HOODIE	110	65701	W POWCHASER LIFALOFT JACKET	91
54412	CREW SOFTSHELL JACKET	71	62981	W NORD GRAPHIC PULL OVER HOODIE	110	65702	LIFALOFT FULL ZIP INSULATOR	25
54429	W ADEN DOWN PARKA	130	62983	W NORD GRAPHIC LONGSLEEVE T-SHIRT	110	65703	W LIFALOFT FULL ZIP INSULATOR	94
54430	W BLUME PUFFY PARKA	130	62987	PARAMOUNT HOODED SOFTSHELL JACKET	33	65713	ICON 4.0 SONIC WELDED STRETCH JACKET	14
57502	BRAND BEANIE	170	62988	W PARAMOUNT HOODED SOFTSHELL JACKET	103	65714	RUSSI SOFTSHELL STRETCH JACKET	14
62047	SEVEN J JACKET	62	62997	ODIN LIFALOFT DOWN HYBRID JACKET	28	65715	AXAMER PUFFY JACKET	14
62066	W SEVEN J JACKET	134	62999	VERGLAS 3L SHELL PANT	30	65716	TRICOLORE INSULATED JACKET	14
62252	LOKE JACKET	34	63000	VERGLAS TUR PANT	30	65717	ICON 4.0 SONIC WELDED PANT	16
62265	LOKE PANTS	34	63001	VEIR TUR PANT	30	65718	RUSSI SOFTSHELL STRETCH PANT	16
62266	W LOKE PANTS	104	63002	VERGLAS ICEFALL DOWN JACKET	31	65719	TRICOLORE QUILTED INSULATOR JACKET	15
62282	W LOKE JACKET	104	63005	VERGLAS HOODED DOWN INSULATOR JACKET	31	65720	TRICOLORE KNITTED SWEATER	15
62368	SQUAMISH CIS JACKET	62	63006	VERGLAS DOWN INSULATOR JACKET	32	65721	W SAPPORO FRINGE STRETCH JACKET	84
62372	SEVEN J PANT	62	63007	VERGLAS HOODED DOWN HYBRID INSULATOR JACKET	32	65722	W ROSI INSULATED SOFTSHELL JACKET	84
62381	W SEVEN J PANT	134	63008	VERGLAS DOWN INSULATOR VEST	32	65723	W BANCO PUFFY JACKET	84

65724	W TRICOLORE INSULATED JACKET	84	67439	MARINE BAG	190
65725	W ROSI BIB SOFTSHELL PANT	86	67440	H/H SCOUT DUFFEL S	185
65726	W SAPORO STRETCH HIGHWAIST PANT	86	67441	H/H SCOUT DUFFEL M	185
65727	W TRICOLORE QUILTED INSULATOR JACKET	85	67442	H/H SCOUT DUFFEL L	185
65728	W TRICOLORE KNITTED SWEATER	86	67443	H/H SCOUT DUFFEL XL	186
65729	W BANCO PUFFY PANT	87	67444	H/H SCOUT WASH BAG	186
65730	W SNOW BOOT GAITORS	87	67448	FLAG BEANIE	172
65731	W PINNACLE JACKET	87	67450	COZY BEANIE	172
65732	W AVANTI JACKET	87	67451	CHAMPOW BEANIE	174
65733	W VALDISERE PUFFY JACKET	89	67452	LOGO CUFF BEANIE	173
65734	W BLUEBIRD JACKET	89	67453	SEA GEAR BEANIE	172
65736	W BELLISSIMO 2 PANT	90	67454	GLACIER GLOVE	177
65737	W AVANTI STRETCH PANT	89	67455	W GLACIER GLOVE	180
65738	STEILHANG JACKET	16	67457	JUNIPER GLOVE	177
65739	OMEGA JACKET	17	67458	W JUNIPER GLOVE	180
65740	FREEWAY JACKET	18	67460	LEATHER MIX GLOVE	176
65741	RIVA LIFALOFT JACKET	18	67461	ALL MOUNTAIN GLOVE	176
65743	GRAVITATION JACKET	19	67463	W LEATHER MIX GLOVE	179
65745	ULLR CHUGACH POWDER SUIT	20	67464	W ALL MOUNTAIN GLOVE	179
65746	ELEVATION SHELL 3.0 JACKET	20	67465	W FREERIDE MIX GLOVE	180
65747	GARIBALDI 2.0 JACKET	21	67468	ALPINE SOCK WARM	181
65748	SOGN SHELL 2.0 JACKET	21	67469	ALPINE SOCK MEDIUM	181
65749	KICKINGHORSE JACKET	22	67470	ALPINE SOCK TECHNICAL	181
65751	ELEVATION SHELL 3.0 PANT	22	67771	SAILING GLOVE LONG	184
65753	W POWDERQUEEN 3.0 JACKET	90	67772	SAILING GLOVE SHORT	184
65754	W SWITCH CARGO INSULATED PANT	92	67806	VOR GLOVE	178
65755	W LIFALOFT SUIT	85	67809	HH WINTER BEANIE	173
65756	W LIFALOFT TOASTY COAT	92	67963	HH NECK	176
65757	W LIFALOFT SKIRT	94	68084	HH LIFA MERINO GLOVE LINER	179
65758	GARIBALDI 2.0 PANT	23			
65761	ALPHA LIFALOFT™ PANT	19			
65772	ELEVATION INFINITY SHELL JACKET	20			
67000	KITSILANO BACKPACK	187			
67003	HH SEAMLESS CAP	183			
67083	MOUNTAIN BEANIE FLEECE LINED	172			
67145	DAWN PATROL GLOVE	178			
67147	OUTLINE BEANIE	170			
67148	OUTLINE HEADBAND	170			
67149	OUTLINE REVERSIBLE BEANIE	170			
67150	RIDGELINE BEANIE	171			
67152	W POWDER BEANIE	175			
67154	URBAN CUFF BEANIE	173			
67155	HH FLATBRIM TRUCKER CAP	182			
67156	W LIMELIGHT BEANIE	175			
67160	CREW CAP	183			
67162	K OUTLINE BEANIE	166			
67184	OSLO BACKPACK	186			
67187	STOCKHOLM BACKPACK	187			
67188	LOKE BACKPACK	187			
67195	BUSINESS BEANIE 2	174			
67266	W CALGARY CHUNKY BEANIE	175			
67300	HH BRAND CAP	182			
67306	HH MERINO NECK	175			
67324	SWIFT HT GLOVE	177			
67332	HH FLEECE TOUCH GLOVE LINER	179			
67335	SWIFT HT MITTENS	178			
67346	JR SWIFT HT MITTEN	181			
67352	JR SWIFT HT GLOVE	180			
67363	HH WEBBING BELT	183			
67370	HH OCEAN DRY BAG L	188			
67371	HH OCEAN DRY BAG XL	188			
67372	HH LIGHT DRY BAG 3L	188			
67373	HH LIGHT DRY BAG 7L	188			
67374	HH LIGHT DRY BAG 12L	189			
67375	HH LIGHT DRY BAG 20L	189			
67381	HH RACING BAG	189			
67386	DUBLIN 2.0 BACKPACK	186			
67403	HH WOOL CAP	182			
67404	TRAVERSE BEANIE	171			
67405	CHILL KNIT BEANIE	173			
67406	HH FLEECE BEANIE	174			
67407	W SNOWFALL BEANIE	174			
67413	HH ADVENTURE BELT	182			
67415	ROAM TRAPPER HAT	40			
67417	ODIN GLOVES	176			
67418	ROAM GLOVES	40			
67418	ROAM GLOVES	178			
67421	SPORT DUFFEL 50L	184			
67428	K MERINO BEANIE	166			
67431	SPORT DUFFEL 70L	184			
67432	SPORT DUFFEL 90L	185			
67433	MARINE TOTE	189			
67436	VISBY BACKPACK	187			



 TRUSTED BY
PROFESSIONALS



ALIVE
SINCE / 1877





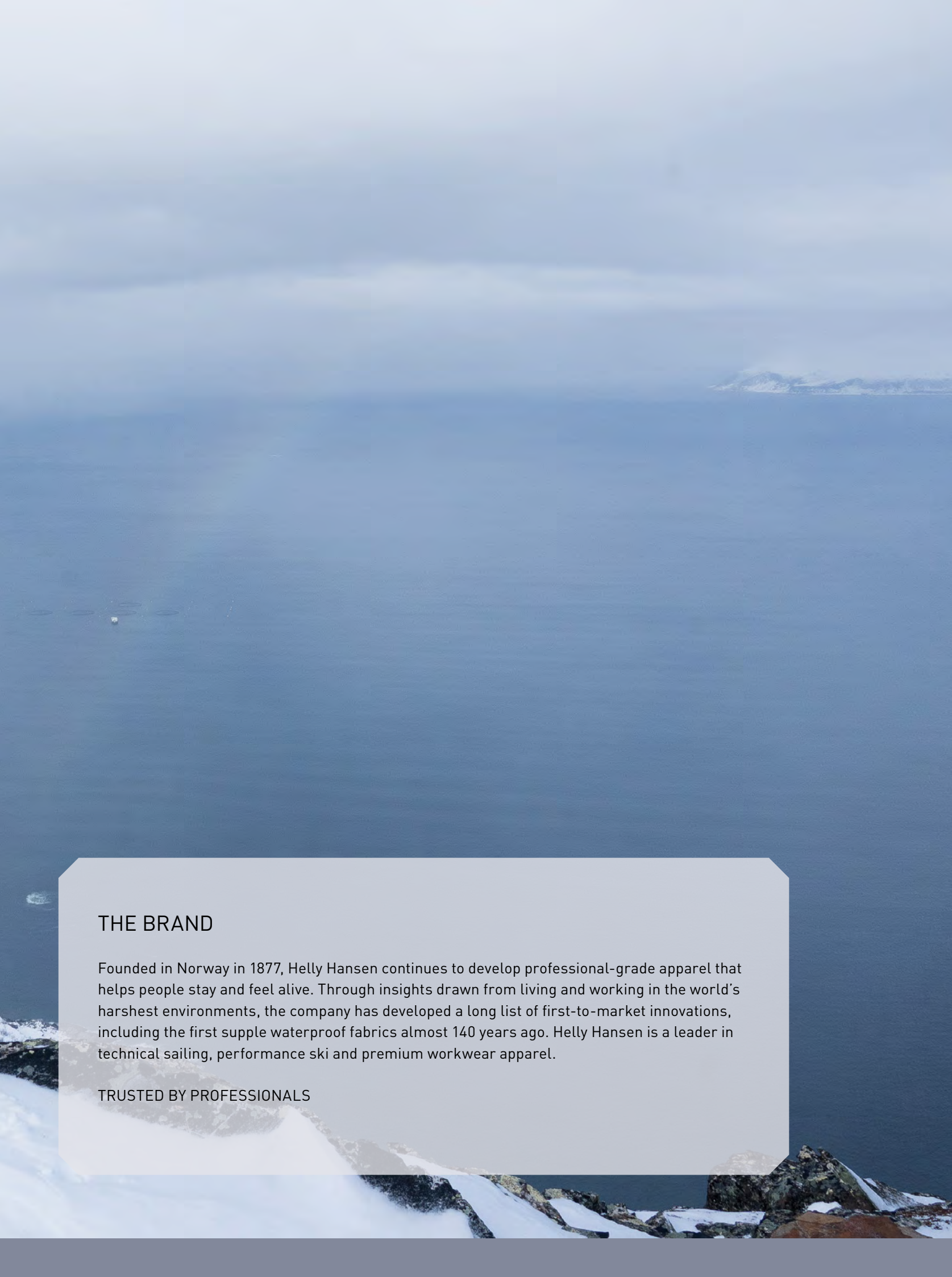

THE BRAND

Founded in Norway in 1877, Helly Hansen continues to develop professional-grade apparel that helps people stay and feel alive. Through insights drawn from living and working in the world's harshest environments, the company has developed a long list of first-to-market innovations, including the first supple waterproof fabrics almost 140 years ago. Helly Hansen is a leader in technical sailing, performance ski and premium workwear apparel.

TRUSTED BY PROFESSIONALS



ALIVE
SINCE / 1877



MIX
Paper from
responsible sources
FSC® C134744

